

DAIKIN ROOM AIR CONDITIONER

# OPERATION MANUAL

**INVERTER**



## MODELS

- FTXM85PVMA
- FTXM95PVMA

# Features

## Enhanced comfort and energy savings



### INTELLIGENT EYE

The INTELLIGENT EYE sensor detects human movement in a room. If no one is in the room for more than 20 minutes, the operation automatically changes to energy saving operation. ▶ [Page 15](#)



### WEEKLY TIMER

Up to 4 timer settings can be saved for each day of the week according to your family's life style. The WEEKLY TIMER allows you to set on/off times and the desired temperature. ▶ [Page 21](#)

## Other functions



### COMFORT AIRFLOW

The airflow direction is upward while in COOL operation, and downward while in HEAT operation. This function prevents cold or warm air from blowing directly on your body. ▶ [Page 15](#)



### OUTDOOR UNIT QUIET

OUTDOOR UNIT QUIET operation assures a low noise level of the outdoor unit. This function is useful to maintain a quiet neighbourhood. ▶ [Page 18](#)



## ECONO



This function enables efficient operation by limiting the maximum power consumption. It is useful when using the air conditioner and other electrical devices simultaneously on a shared electrical circuit. ▶ Page 18

# Contents



## ■ Read Before Operation

Safety Precautions.....	3
Names of Parts .....	5
Preparation Before Operation .....	9



## ■ Basic Operation

 AUTO · DRY · COOL · HEAT · FAN Operation .....	11
 Adjusting the Airflow Direction .....	13
 Adjusting the Airflow Rate.....	14

## ■ Useful Functions

 COMFORT AIRFLOW / INTELLIGENT EYE Operation.....	15
 POWERFUL Operation.....	17
 ECONO / OUTDOOR UNIT QUIET Operation .....	18

## ■ TIMER Operation

 ON/OFF TIMER Operation .....	19
 WEEKLY TIMER Operation.....	21

## ■ Care

Care and Cleaning.....	27
------------------------	----

## ■ When the Need Arises

FAQ.....	32
Troubleshooting .....	33

# Safety Precautions







Read the precautions in this manual carefully before operating the unit.



This appliance is filled with R32.

- Keep this manual where the user can easily find it.
- The precautions described herein are classified as WARNING and CAUTION. They both contain important information regarding safety. Be sure to observe all precautions without fail.

 <b>WARNING</b>	 <b>CAUTION</b>
Failure to follow these instructions properly may result in personal injury or loss of life.	Failure to follow these instructions properly may result in property damage or personal injury, which may be serious depending on the circumstances.

 Never attempt.	 Be sure to follow the instructions.	 Be sure to establish an earth connection.
--	---	---

- After reading, keep this manual in a convenient place so that you can refer to it whenever necessary. If the equipment is transferred to a new user, be sure also to hand over the manual.

## **WARNING**



- Do not use means to accelerate the defrosting process or to clean, other than those recommended by the manufacturer.
- The appliance must be stored in a room without continuously operating ignition sources (for example: open flames, an operating gas appliance or an operating electric heater).
- Do not pierce or burn.
- Be aware that refrigerants may not contain an odour.
- The appliance must be installed, operated and stored in a room with a floor area larger than 8.7m<sup>2</sup>.
- To avoid fire, explosion or injury, do not operate the unit when harmful gases (e.g. flammable or corrosive) are detected near the unit.
- Be aware that prolonged, direct exposure to cool or warm air from the air conditioner, or to air that is too cool or too warm, can be harmful to your physical condition and health.
- Do not place objects, including rods, your fingers, etc., in the air inlet or outlet. Product damage or personal injury may result due to contact with the air conditioner's high-speed fan blades.
- Do not attempt to repair, dismantle, reinstall or modify the air conditioner yourself as this may result in water leakage, electric shocks or fire hazards.
- Do not use flammable spray near the air conditioner, or otherwise fire may result.
- Do not use a refrigerant other than the one indicated on the outdoor unit (R32) when installing, moving or repairing. Using other refrigerants may cause trouble or damage to the unit, and personal injury.
- To avoid electric shocks, do not operate with wet hands.



- Beware of fire in case of refrigerant leakage. If the air conditioner is not operating correctly, i.e. not generating cool or warm air, refrigerant leakage could be the cause. Consult your dealer for assistance. The refrigerant within the air conditioner is safe and normally does not leak. However, in the event of a leakage, contact with a naked burner, heater or cooker may result in generation of noxious gas. Do not use the air conditioner until a qualified service person confirms that the leakage has been repaired.
- Do not attempt to install or repair the air conditioner yourself. Improper workmanship may result in water leakage, electric shocks or fire hazards. Please contact your local dealer or qualified personnel for installation and maintenance work.
- If the air conditioner is malfunctioning (giving off a burning odour, etc.), turn off power to the unit and contact your local dealer. Continued operation under such circumstances may result in a failure, electric shocks or fire hazards.
- Be sure to install an earth leakage circuit breaker. Failure to install an earth leakage circuit breaker may result in electric shocks or fire.



- Be sure to earth the unit. Do not earth the unit to a utility pipe, lightning conductor or telephone earth lead. Imperfect earthing may result in electric shocks.

## **CAUTION**



- Do not use the air conditioner for purposes other than those for which it is intended. Do not use the air conditioner for cooling precision instruments, food, plants, animals or works of art as this may adversely affect the performance, quality and/or longevity of the object concerned.
- Do not expose plants or animals directly to the airflow from the unit as this may cause adverse effects.
- Do not place appliances that produce naked flames in places exposed to the airflow from the unit as this may impair combustion of the burner.

## CAUTION



- Do not block the air inlets nor outlets. Impaired airflow may result in insufficient performance or trouble.
- Do not sit on the outdoor unit, put things on the unit, or pull the unit. Doing so may cause accidents, such as falling or toppling down, thus resulting in injury, product malfunctioning, or product damage.
- Do not place objects that are susceptible to moisture directly beneath the indoor or outdoor units. Under certain conditions, condensation on the main unit or refrigerant pipes, air filter dirt or drain blockage may cause dripping, resulting in fouling or failure of the object concerned.
- After prolonged use, check the unit stand and its mounts for damage. If they are left in a damaged condition, the unit may fall and cause injury.
- To avoid injury, do not touch the air inlet or aluminium fins of the indoor or outdoor units.
- The appliance is not intended for use by unattended young children or infirm persons. Impairment of bodily functions and harm to health may result.
- Children should be supervised to ensure that they do not play with the unit or its remote controller. Accidental operation by a child may result in impairment of bodily functions and harm health.
- Avoid impacts to the indoor and outdoor units, or otherwise product damage may result.
- Do not place flammable items, such as spray cans, within 1m of the air outlet.  
The spray cans may explode as a result of hot air from the indoor or outdoor units.
- Be careful not to let pets urinate on the air conditioner. Urination on the air conditioner may result in electric shocks or fire.
- Do not wash the air conditioner with water, as this may result in electric shocks or fire.
- Do not place water containers (vases, etc.) above the unit, as this may result in electric shocks or fire hazards if they should topple over.



- To avoid oxygen depletion, ensure that the room is adequately ventilated if equipment such as a burner is used together with the air conditioner.
- Before cleaning, be sure to stop unit operation and turn off the circuit breaker. Otherwise, an electric shock and injury may result.
- Only connect the air conditioner to the specified power supply circuit. Power supplies other than the one specified may result in electric shocks, overheating and fires.
- Arrange the drain hose to ensure smooth drainage. Imperfect drainage may cause wetting of the building, furniture, etc.
- Do not place objects in direct proximity of the outdoor unit and do not let leaves and other debris accumulate around the unit. Leaves are a hotbed for small animals which can enter the unit. Once inside the unit, such animals can cause malfunctions, smoke or fire if they come into contact with electrical parts.
- Do not place objects around the indoor unit.  
Doing so may have an adverse influence on the performance, product quality, and life of the air conditioner.

P004

### Installation site

- To install the air conditioner in the following types of environments, consult your dealer.
  - Places with an oily environment or where steam or soot occurs.
  - Salty environments such as coastal areas.
  - Places where sulphide gas occurs such as hot springs.
  - Places where snow may block the outdoor unit.
- Be sure to follow the instructions below.
  - The indoor unit is at least 1m away from any television or radio set (unit may cause interference with the picture or sound).
  - The drain from the outdoor unit must be discharged to a place of good drainage.

### Consider nuisance to your neighbours from noises

- For installation, choose a place as described below.
  - A place solid enough to bear the weight of the unit and which does not amplify the operation noise or vibration.
  - A place from where the air discharged from the outdoor unit or the operation noise will not annoy your neighbours.

### Electrical work

- For the power supply, be sure to use a separate power circuit dedicated to the air conditioner.

### System relocation

- Relocating the air conditioner requires specialized knowledge and skills. Please consult your dealer if relocation is necessary for moving or remodelling.

# Names of Parts

## Indoor Unit

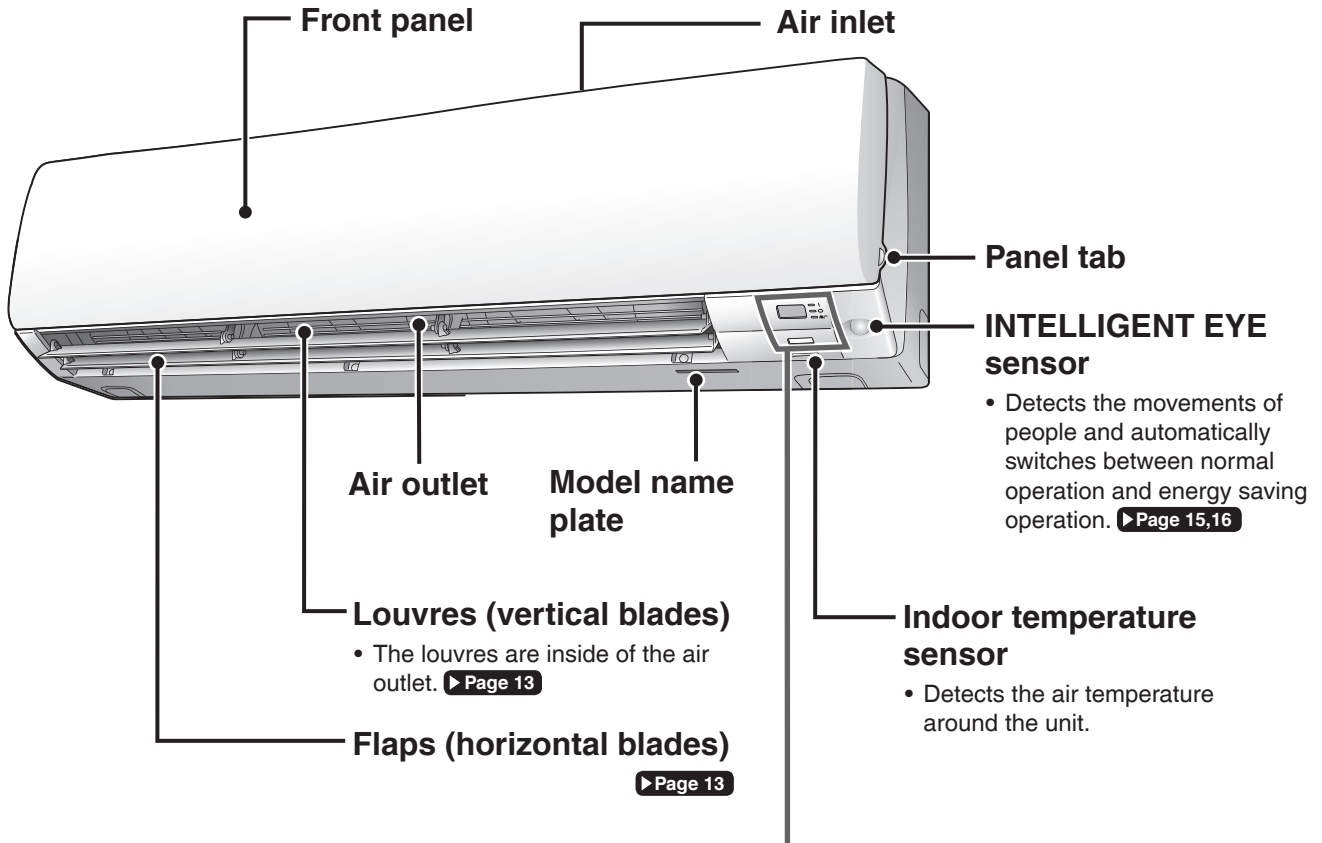

## Display

### Signal receiver

- Receives signals from the remote controller.
- When the unit receives a signal, you will hear a beep sound.

Case	Sound type
Operation start	beep-beep
Setting changed	beep
Operation stop	long beep

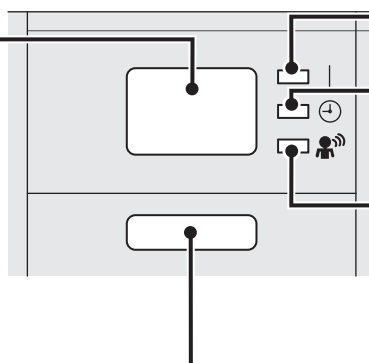

**OPERATION lamp (green)**

**TIMER lamp (orange)**

▶ Page 19,20,23,25

**INTELLIGENT EYE lamp (green)**

▶ Page 15

### Indoor unit ON/OFF switch

- Press this switch once to start operation. Press once again to stop it.
- For the operation mode setting, refer to the following table.

Mode	Temperature setting	Airflow rate
AUTO	25°C	AUTO

- This switch can be used when the remote controller is missing.

■ Open the front panel

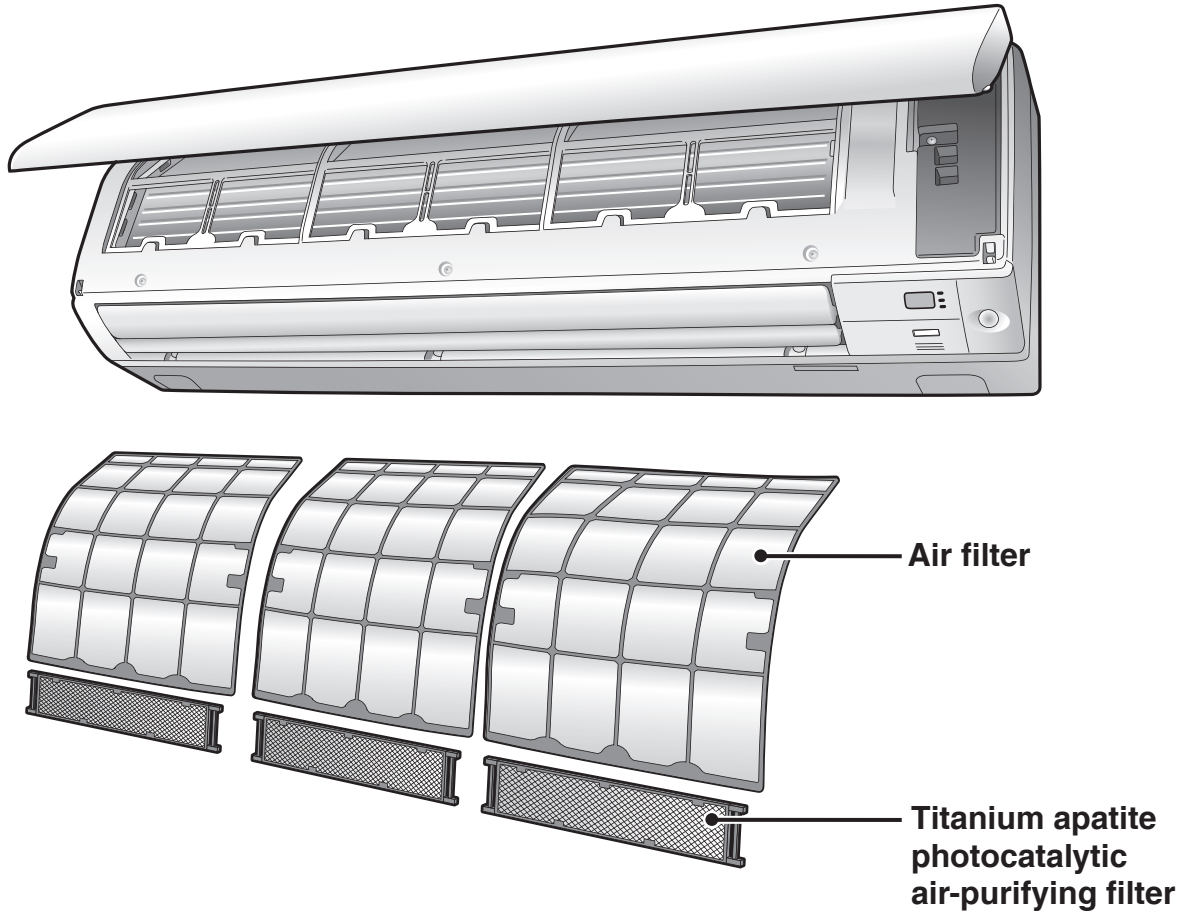

**Outdoor Unit**

• The appearance of the outdoor unit may differ between different models.

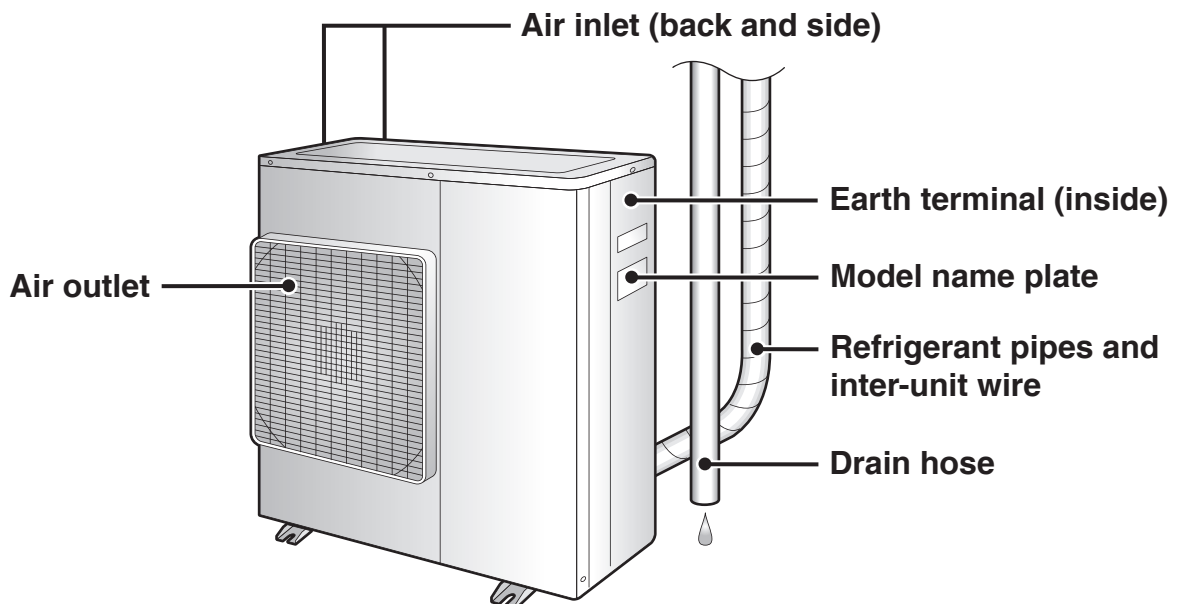

# Names of Parts

## Remote Controller

### Signal transmitter

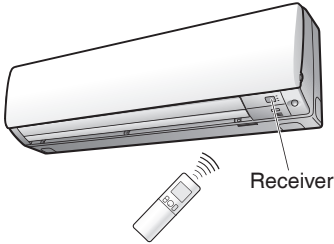

- To use the remote controller, aim the transmitter at the indoor unit. If there is anything blocking the signals between the unit and the remote controller, such as a curtain, the unit may not operate.
- The maximum transmission distance is about 7m.

### Display (LCD)

- Displays the current settings. (In this illustration, each section is shown with all its displays on for the purpose of explanation.)

### TEMPERATURE adjustment button

- Changes the temperature setting.

▶ Page 12

### FAN setting button

- Selects the airflow rate setting.

▶ Page 14

### POWERFUL button

- POWERFUL operation. ▶ Page 17

### ON/OFF button

- Press this button once to start operation.

Press once again to stop it. ▶ Page 11

### Front cover

- Open the front cover. ▶ Page 8

Model	ARC466A16
-------	-----------



■ Open the front cover

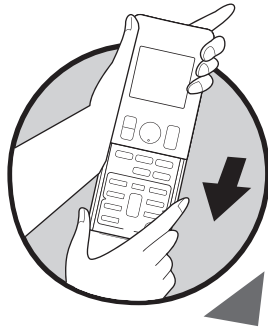

**MODE selector button**

- Selects the operation mode. (AUTO/DRY/COOL/HEAT/FAN)

▶ Page 11

**ECONO/QUIET button**

- ECONO/OUTDOOR UNIT QUIET operation. ▶ Page 18

**SWING button**

- Adjusts the airflow direction. ▶ Page 13

**COMFORT/SENSOR button**

- COMFORT AIRFLOW and INTELLIGENT EYE operation. ▶ Page 15

**OFF TIMER button (NIGHT SET mode)**

▶ Page 20

**TIMER CANCEL button**

- Cancels the timer setting. ▶ Page 19,20
- Cannot be used for the WEEKLY TIMER operation.

**SELECT button**

- Changes the clock, ON/OFF TIMER and WEEKLY TIMER settings.

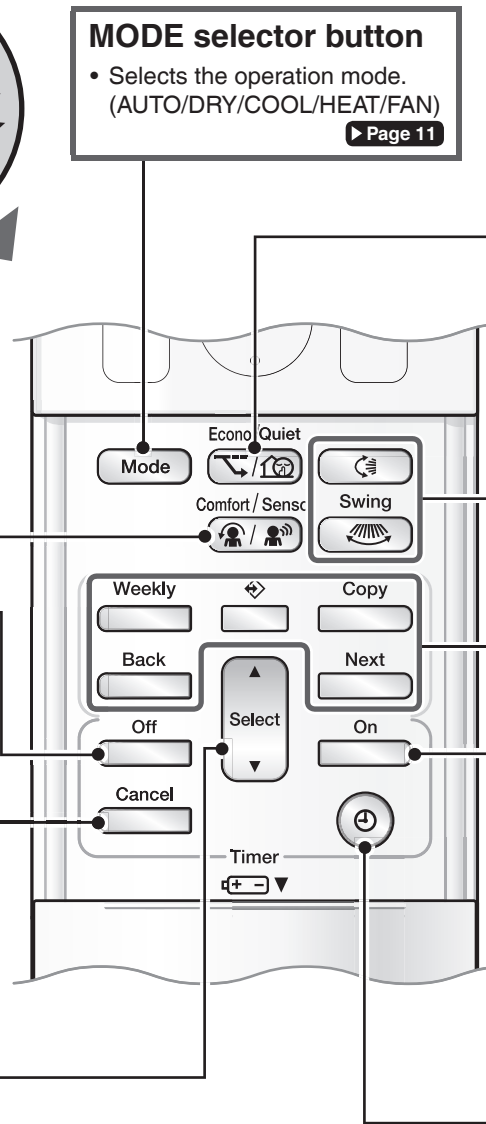

**Weekly**

◻ : WEEKLY button

◊ : PROGRAMME button

◻ : COPY button

◻ : BACK button

◻ : NEXT button

- WEEKLY TIMER operation. ▶ Page 21

**ON TIMER button**

▶ Page 19

**CLOCK button**

▶ Page 10

# Preparation Before Operation

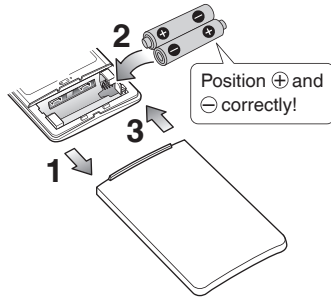

## To insert the batteries

1. Slide the front cover to take it off.
2. Insert 2 dry batteries AAA.LR03 (alkaline).
3. Replace the front cover.

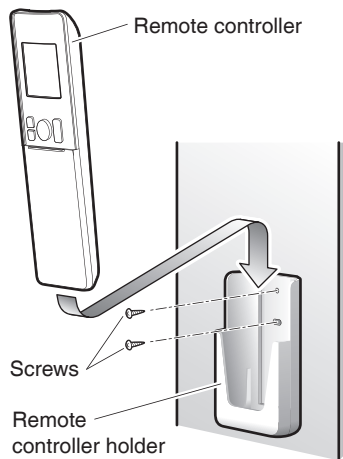

## To fix the remote controller holder to a wall

1. Choose a place from where the signals reach the unit.
2. Fix the holder to a wall, a pillar, or similar location with the screws supplied with the holder.
3. Place the remote controller in the remote controller holder.

## Turn on the circuit breaker

- After the power is turned on, the flaps of the indoor unit open and close once to set the reference position.

## NOTE

### Notes on batteries

- When replacing the batteries, use batteries of the same type, and replace both old batteries together.
- The batteries will last for about 1 year. If the remote controller display begins to fade and the possible transmission range becomes shorter within a year, however, replace both batteries with new, size AAA.LR03 (alkaline).
- The batteries supplied with the remote controller are for initial operation. The batteries may run out in less than 1 year.

### Note on remote controller

- Do not drop the remote controller. Do not get it wet.

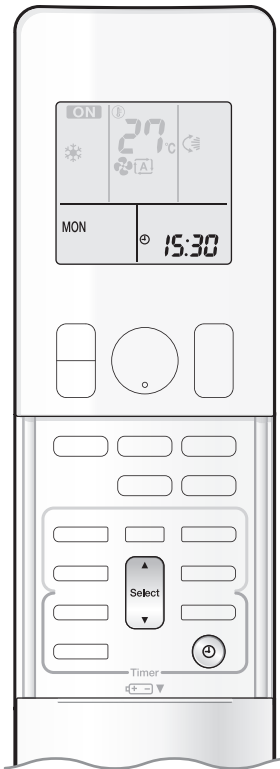

## To set the clock

**1. Press** .

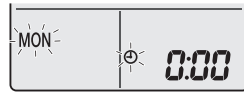

“0:00” is displayed on the LCD.  
“MON” and “” blink.

**2. Press**  **to set the current day of the week.**

**3. Press** .



“” blinks.

**4. Press**  **to set the clock to the present time.**

- Holding down  or  rapidly increases or decreases the displayed time.

**5. Press** .

- Point the remote controller at the indoor unit when pressing the buttons.



“:” blinks.

## NOTE

### Note on setting the clock

- If the indoor unit's internal clock is not set to the correct time, the ON/OFF TIMER and WEEKLY TIMER will not operate punctually.



# AUTO · DRY · COOL · HEAT · FAN Operation

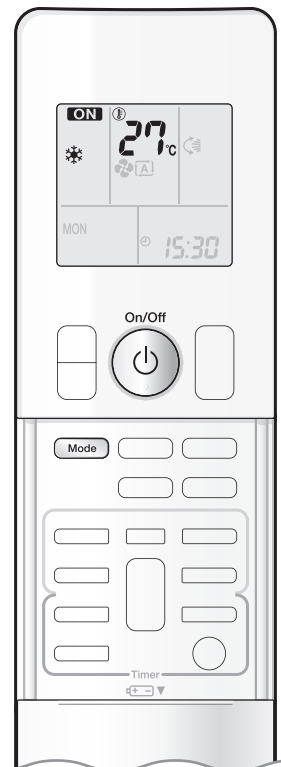

The air conditioner operates with the operation mode of your choice. From the next time on, the air conditioner will operate with the same operation mode.

## To start operation

### 1. Press and select a operation mode.

- Each pressing of the button changes the mode setting in sequence.

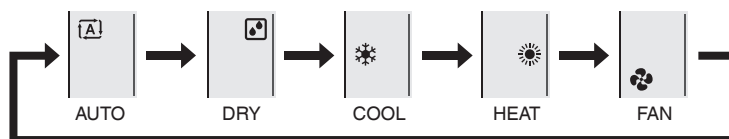

### 2. Press .

- “**ON**” is displayed on the LCD.
- The OPERATION lamp lights green.



Display

## To stop operation

### Press again.

- “**ON**” disappears from the LCD.
- The OPERATION lamp goes off.

## NOTE

### Notes on AUTO operation

- In AUTO operation, the system selects an appropriate operation mode (COOL or HEAT) based on the indoor temperature and starts the operation.
- The system automatically reselects setting at a regular interval to bring the indoor temperature to the user-setting level.

### Note on DRY operation

- Eliminates humidity while maintaining the indoor temperature as much as possible. It automatically controls temperature and airflow rate, so manual adjustment of these functions is unavailable.



## To change the temperature setting

Press  .

- Press ▲ to raise the temperature and press ▼ to lower the temperature.

COOL operation	HEAT operation	AUTO operation	DRY or FAN operation
18 – 32°C	10 – 30°C	18 – 30°C	The temperature setting cannot be changed.

## Tips for saving energy

**Keeping the temperature setting at a moderate level helps save energy.**

- Recommended temperature setting
  - For cooling : 26-28°C
  - For heating : 20-24°C

**Cover windows with a blind or a curtain.**

- Blocking sunlight and air from outdoors increases the cooling (heating) effect.

**Keep the air filters clean.**

- Clogged air filters cause inefficient operation and waste energy. Clean them once in about every 2 weeks. ▶ [Page 29](#)

**If you are not going to use the air conditioner for a long period, for example in spring or autumn, turn off the circuit breaker.**

- The air conditioner always consumes a small amount of electricity even while it is not operating.





# Adjusting the Airflow Direction

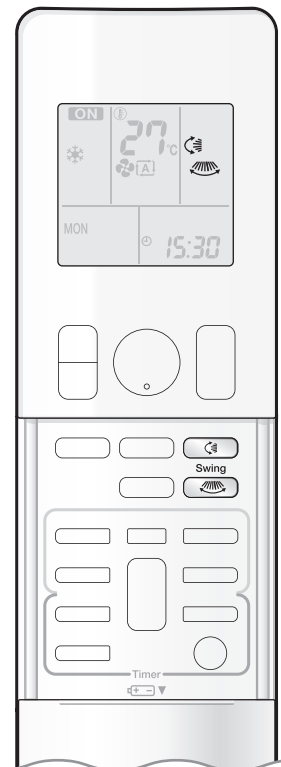

You can adjust the airflow direction to increase your comfort.

## ⚠ CAUTION

- Always use a remote controller to adjust the angles of the flaps and louvres.
  - If you attempt to move the flaps and louvres forcibly by hand when they are swinging, the mechanism may be damaged.
  - Inside the air outlet, a fan is rotating at a high speed.

### To start auto swing

#### Up and down airflow direction

▶ Press  .

- “” is displayed on the LCD.
- The flaps (horizontal blades) will begin to swing.

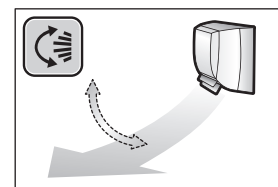

#### Right and left airflow direction



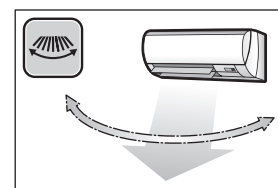

▶ Press  .

- “” is displayed on the LCD.
- The louvres (vertical blades) will begin to swing.



#### The 3-D airflow direction

▶ Press  and  .

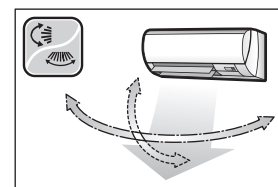

- “” and “” are displayed on the LCD.
- The flaps and louvres move in turn.
- To cancel 3-D airflow, press either  or  again. The flaps or louvres will stop moving.



### To set the flaps or louvres at the desired position

- This function is effective while the flaps or louvres are in auto swing mode.

▶ Press  and  when the flaps or louvres reach the desired position.

- In the 3-D airflow, the flaps and louvres move in turn.
- “” or “” disappears from the LCD.



# Adjusting the Airflow Rate

You can adjust the airflow rate to increase your comfort.

## To adjust the airflow rate setting

Press .

- Each pressing of changes the airflow rate setting in sequence.

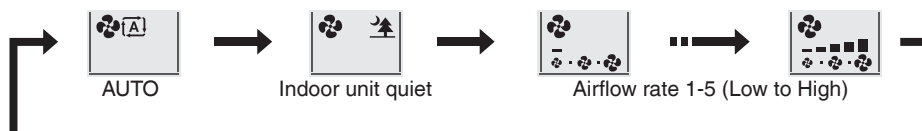

- When the airflow is set to “”, quiet operation starts and noise from the indoor unit will become quieter.
- In the quiet operation mode, the airflow rate is set to a weak level.

AUTO, COOL, HEAT and FAN operation	DRY operation
→  →  →	The airflow rate setting cannot be changed.

## NOTE

### Note on airflow direction setting

- The movable range of the flaps varies according to the operation mode.

### Movable range of the flaps

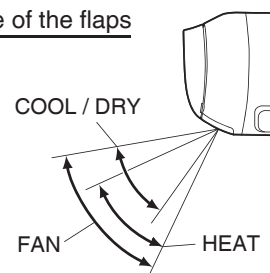

### Note on 3-D airflow

- Using 3-D airflow circulates cold air, which tends to be collected at the bottom of the room, and hot air, which tends to collect near the ceiling, throughout the room, preventing areas of cold and hot developing.

### Note on airflow rate setting

- At smaller airflow rates, the cooling (heating) effect is also smaller.



# COMFORT AIRFLOW / INTELLIGENT EYE Operation

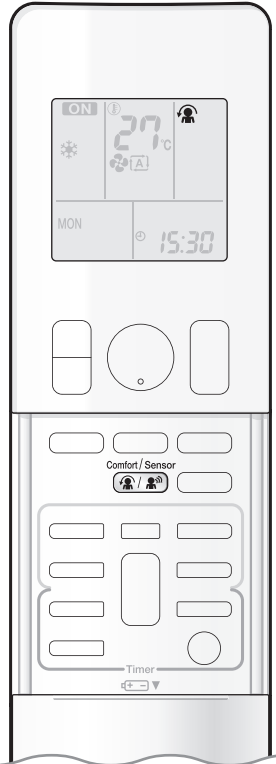

**COMFORT AIRFLOW operation:** The airflow direction is upward while in COOL operation, and downward while in HEAT operation. This function prevents cold or warm air from blowing directly on the occupants in the room.

**INTELLIGENT EYE operation:** The INTELLIGENT EYE sensor detects human movement. If no one is in the room for more than 20 minutes, the operation automatically changes to energy saving operation.

## ⚠ CAUTION

- Do not place large objects near the INTELLIGENT EYE sensor. Also keep heating units and humidifiers outside the sensor's detection area. This sensor can detect undesirable objects.
- Do not hit or violently push the INTELLIGENT EYE sensor. This can lead to damage and malfunction.

## To start operation

▶ Press  and select the desired mode.

- Each time  is pressed, a different setting option is displayed on the LCD.
- The INTELLIGENT EYE lamp lights green.

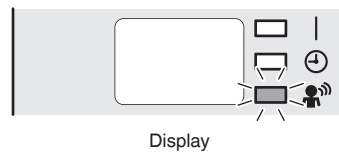

- By selecting “” from the following icons, the air conditioner will switch to COMFORT AIRFLOW operation combined with INTELLIGENT EYE operation.

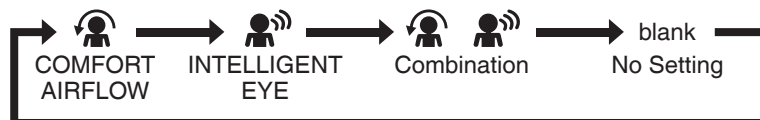

- When the flaps (horizontal blades) are swinging, selecting any of the modes above will cause the flaps (horizontal blades) to stop.
- The lamp lights when human movement is detected.

## To cancel operation

▶ Press  until no icon is displayed.

- The INTELLIGENT EYE lamp goes off.



## INTELLIGENT EYE operation is useful for energy saving

### ■ People is detected in the sensing area.

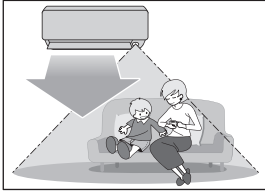

The air conditioner is in normal operation while the sensor is detecting human movement.

### ■ No people are detected in the sensing area.

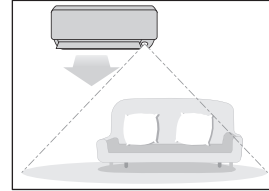

The air conditioner will switch to energy-saving mode after 20 minutes.

### Energy saving operation

- If no presence detected in the room for 20 minutes, energy saving operation starts automatically.
- This operation changes the temperature by  $-2^{\circ}\text{C}$  in HEAT /  $+2^{\circ}\text{C}$  in COOL /  $+2^{\circ}\text{C}$  in DRY operation from the set temperature. When the room temperature exceeds  $30^{\circ}\text{C}$ , the operation changes the temperature by  $+1^{\circ}\text{C}$  in COOL /  $+1^{\circ}\text{C}$  in DRY operation from the set temperature.
- This operation decreases the airflow rate slightly in FAN operation only.

## NOTE

### Note on COMFORT AIRFLOW operation

- The airflow rate will be set to AUTO. If the up and down airflow direction is selected, COMFORT AIRFLOW operation will be cancelled.

### Notes on INTELLIGENT EYE operation

- Application range is as follows.

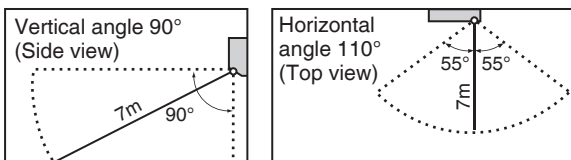

- The sensor may not detect moving objects further than 7m away. (Please see the application range)
- Sensor detection sensitivity changes according to the indoor unit location, the speed of passers-by, temperature range, etc.
- The sensor could also mistakenly detect pets, sunlight, fluttering curtains and light reflected off of mirrors as passers-by.
- INTELLIGENT EYE operation will not switch on during POWERFUL operation.
- NIGHT SET mode [▶ Page 20](#) will not switch on during use of INTELLIGENT EYE operation.

### Note on combination of COMFORT AIRFLOW operation and INTELLIGENT EYE operation

- The airflow rate will be set to AUTO. If the up and down airflow direction is selected, COMFORT AIRFLOW operation will be canceled. Priority is given to the function of whichever button is pressed last.



# POWERFUL Operation

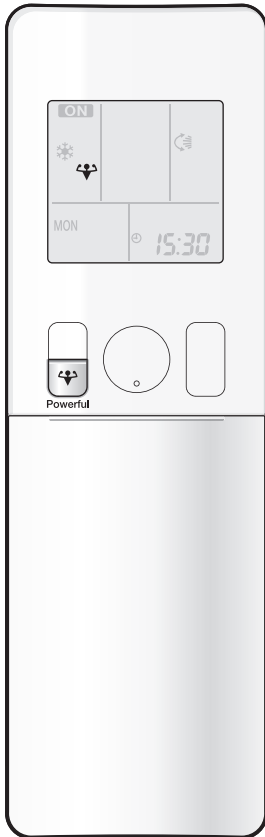

POWERFUL operation quickly maximizes the cooling (heating) effect in any operation mode. In this mode, the air conditioner operates at maximum capacity.

## To start POWERFUL operation

Press  during operation.

- “” is displayed on the LCD.
- POWERFUL operation ends in 20 minutes. Then the system automatically operates again with the previous settings which were used before POWERFUL operation.



## To cancel POWERFUL operation

Press  again.

- “” disappears from the LCD.

## NOTE

### Notes on POWERFUL operation

- Pressing  causes the settings to be cancelled, and “” disappears from the LCD.
- POWERFUL operation will not increase the capacity of the air conditioner if the air conditioner is already in operation with its maximum capacity demonstrated.
  - In **COOL, HEAT and AUTO** operation  
To maximize the cooling (heating) effect, the capacity of outdoor unit increases and the airflow rate becomes fixed at the maximum setting. The temperature and airflow settings cannot be changed.
  - In **DRY** operation  
The temperature setting is lowered by 2.5°C and the airflow rate is slightly increased.
  - In **FAN** operation  
The airflow rate is fixed at the maximum setting.

### Regarding the combination of POWERFUL and other operations

POWERFUL + COMFORT AIRFLOW	Not available*
POWERFUL + ECONO	
POWERFUL + OUTDOOR UNIT QUIET	

\*Priority is given to the function of whichever button is pressed last.



# ECONO / OUTDOOR UNIT QUIET Operation

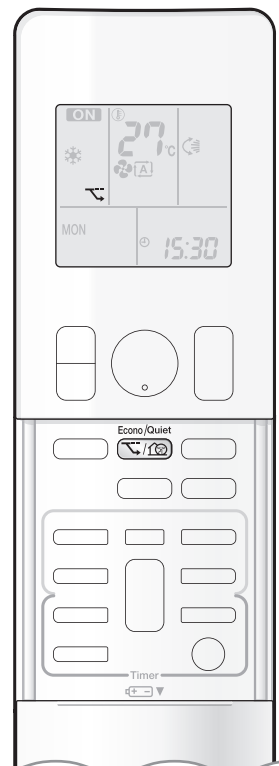

**ECONO operation** enables efficient operation by limiting the maximum power consumption.

This function is useful to prevent the circuit breaker from tripping when the unit operates alongside other appliances on the same circuit.

**OUTDOOR UNIT QUIET operation** lowers the noise level of the outdoor unit by changing the frequency and fan speed of the outdoor unit. This function is convenient during the night-time operation.

## To start operation

Press  and select the desired mode.

- Each time  is pressed, a different setting option is displayed on the LCD.

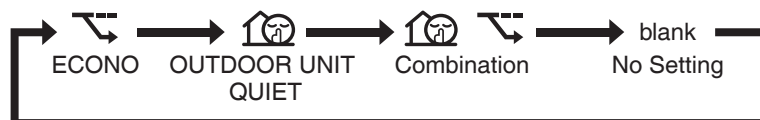



## To cancel operation

Press  until no icon is displayed.

## NOTE

### Notes on ECONO operation

- Pressing  causes the settings to be cancelled, and “” disappears from the LCD.
- If the power consumption level is already low, switching to ECONO operation will not reduce the power consumption.

### Notes on OUTDOOR UNIT QUIET operation

- Even if the operation is stopped by using the remote controller or the indoor unit ON/OFF switch when using OUTDOOR UNIT QUIET operation, “” will remain lit on the remote controller display.
- OUTDOOR UNIT QUIET operation will not reduce the frequency nor fan speed if they already are operating at reduced levels.
- This operation is performed with lower power and therefore may not provide a sufficient cooling (heating) effect.

### Possible combinations of ECONO / OUTDOOR UNIT QUIET operation and basic operations

	Operation mode				
	AUTO	DRY	COOL	HEAT	FAN
ECONO	✓	✓	✓	✓	✗
OUTDOOR UNIT QUIET	✓	✗	✓	✓	✗



# ON/OFF TIMER Operation

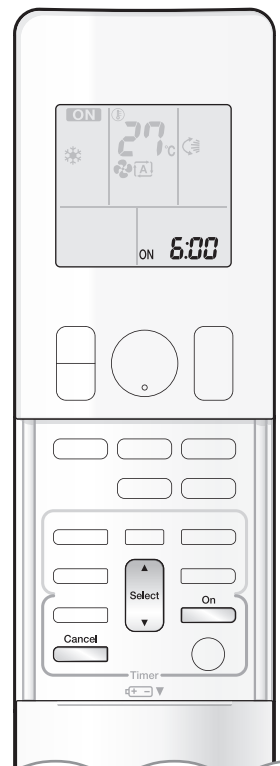

Timer functions are useful for automatically switching the air conditioner on or off at night or in the morning. You can also use the ON TIMER and OFF TIMER together.

## To use ON TIMER operation

- Check that the clock is correct.  
If not, set the clock to the present time. ▶ Page 10

**1. Press** .

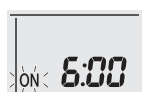

“6:00” is displayed on the LCD.  
“ON” blinks.

- “⌚” and day of the week disappear from the LCD.

**2. Press** **until the time setting reaches the point you like.**

- Each pressing of either button increases or decreases the time setting by 10 minutes.  
Holding down either button changes the setting rapidly.

**3. Press** **again.**

- “ON” and setting time are displayed on the LCD.
- The TIMER lamp lights orange.



Display

## To cancel ON TIMER operation

**Press** .

- “ON” and setting time disappear from the LCD.
- “⌚” and day of the week are displayed on the LCD.
- The TIMER lamp goes off.

## NOTE

### Notes on TIMER operation

- When TIMER is set, the present time is not displayed.
- When operating the unit via the ON/OFF TIMER, the actual length of operation may vary from the time entered by the user. (Maximum about 10 minutes)

### In the following cases, set the timer again.

- After the circuit breaker has turned off.
- After a power failure.
- After replacing the batteries in the remote controller.

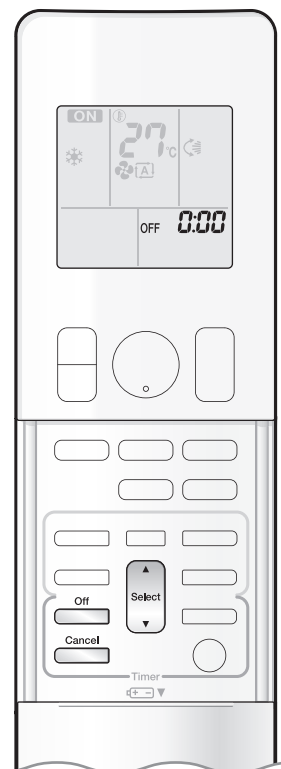

## To use OFF TIMER operation

- Check that the clock is correct.  
If not, set the clock to the present time. ▶ Page 10

### 1. Press .



“0:00” is displayed on the LCD.  
“OFF” blinks.

- “⌚” and day of the week disappear from the LCD.

### 2. Press until the time setting reaches the point you like.

- Each pressing of either button increases or decreases the time setting by 10 minutes.  
Holding down either button changes the time setting rapidly.

### 3. Press again.

- “OFF” and setting time are displayed on the LCD.
- The TIMER lamp lights orange.



Display

## To cancel OFF TIMER operation

### Press .

- “OFF” and setting time disappear from the LCD.
- “⌚” and day of the week are displayed on the LCD.
- The TIMER lamp goes off.

## To combine ON TIMER and OFF TIMER operation

- A sample setting for combining the 2 timers is shown below.

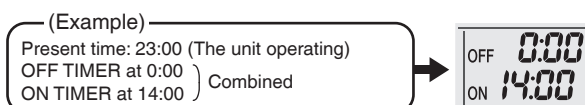

## NOTE

### NIGHT SET mode

- When the OFF TIMER is set, the air conditioner automatically adjusts the temperature setting (0.5°C up in COOL, 2.0°C down in HEAT) to prevent excessive cooling (heating) during sleeping hours.



# WEEKLY TIMER Operation

Up to 4 timer settings can be saved for each day of the week. This is convenient to adapt the WEEKLY TIMER to your family's life style.

## Setting example of the WEEKLY TIMER

The same timer settings are used from Monday through Friday, while different timer settings are used for the weekend.

<p><b>[Monday]</b></p>	<p>Make timer settings for programmes 1-4. ▶Page 22</p> <p><b>Programme 1</b>      <b>Programme 2</b>      <b>Programme 3</b>      <b>Programme 4</b></p> <p>ON                      OFF                      ON                      OFF</p>
<p><b>[Tuesday to Friday]</b></p>	<p>Use the copy mode to make settings for Tuesday to Friday, because these settings are the same as those for Monday. ▶Page 24</p> <p><b>Programme 1</b>      <b>Programme 2</b>      <b>Programme 3</b>      <b>Programme 4</b></p> <p>ON                      OFF                      ON                      OFF</p>
<p><b>[Saturday]</b></p>	<p>No timer settings</p>
<p><b>[Sunday]</b></p>	<p>Make timer settings for programmes 1-4. ▶Page 22</p> <p><b>Programme 1</b>      <b>Programme 2</b>      <b>Programme 3</b>      <b>Programme 4</b></p> <p>ON                      OFF                      OFF                      ON</p>

- Up to 4 reservations per day and 28 reservations per week can be set using the WEEKLY TIMER. The effective use of the copy mode simplifies timer programming.
- The use of ON-ON-ON-ON settings, for example, makes it possible to schedule operating mode and set temperature changes. Furthermore, by using OFF-OFF-OFF-OFF settings, only the turn off time of each day can be set. This will turn off the air conditioner automatically if you forget to turn it off.

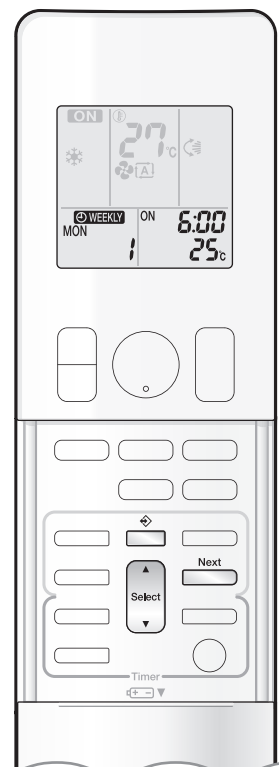

## To use WEEKLY TIMER operation

### Setting mode

- Make sure the day of the week and time are set.  
If not, set the day of the week and time. ▶ [Page 10](#)

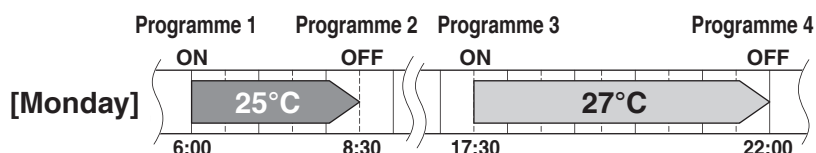

### Setting Displays

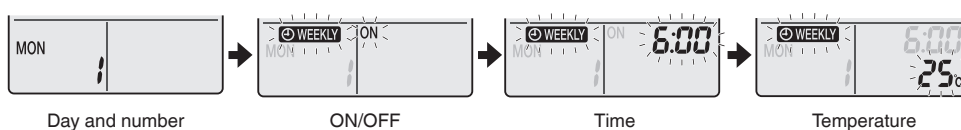

### 1. Press .

- The day of the week and the reservation number of the current day will be displayed.
- 1 to 4 settings can be made per day.

### 2. Press to select the desired day of the week and reservation number.

- Pressing  changes the reservation number and the day of the week.

### 3. Press .

- The day of the week and reservation number will be set.
- “  WEEKLY ” and “ ON ” blink.

### 4. Press to select the desired mode.

- Pressing  changes the “ ON ” or “ OFF ” setting in sequence.

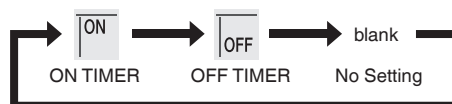

- In case the reservation has already been set, selecting “ blank ” deletes the reservation.
- Proceed to **STEP 9** if “ blank ” is selected.
- To return to the day of the week and reservation number setting, press .

### 5. Press .

- The ON/OFF TIMER mode will be set.
- “  WEEKLY ” and the time blink.



# WEEKLY TIMER Operation

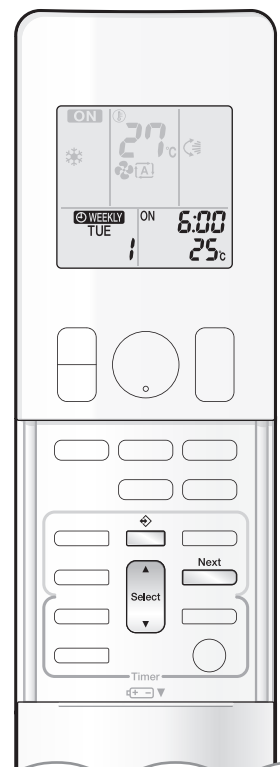

## 6. Press to select the desired time.

- The time can be set between 0:00 and 23:50 in 10-minute intervals.
- To return to the ON/OFF TIMER mode setting, press .
- Proceed to **STEP 9** when setting the OFF TIMER.

## 7. Press .

- The time will be set.
- “ WEEKLY” and the temperature blink.

## 8. Press to select the desired temperature.

- The temperature can be set between 10°C and 32°C.  
COOL or AUTO: The unit operates at 18°C even if it is set to 10 to 17°C. **Page 12**  
HEAT or AUTO : The unit operates at 30°C even if it is set to 31 to 32°C. **Page 12**
- To return to the time setting, press .
- The set temperature is only displayed when the mode setting is on.

## 9. Press .

- The temperature will be set and go to the next reservation setting.
- The temperature is set while in ON TIMER operation, and the time is set while in OFF TIMER operation.
- The next reservation screen will appear.
- To continue further settings, repeat the procedure from **STEP 4**.

## 10. Press to complete the setting.

- Be sure to direct the remote controller toward the indoor unit and check for a receiving tone and blinking of the OPERATION lamp.
- “ WEEKLY” is displayed on the LCD and WEEKLY TIMER operation is activated.
- The TIMER lamp lights orange.



Display

- A reservation made once can be easily copied and the same settings used for another day of the week. Refer to **Copy mode**. **Page 24**

## NOTE

### Notes on WEEKLY TIMER operation

- Do not forget to set the clock on the remote controller first. **Page 10**
- The day of the week, ON/OFF TIMER mode, time and set temperature (only for ON TIMER mode) can be set with the WEEKLY TIMER. Other settings for the ON TIMER are based on the settings just before the operation.
- WEEKLY TIMER and ON/OFF TIMER operation cannot be used at the same time. The ON/OFF TIMER operation has priority if it is set while WEEKLY TIMER is still active. The WEEKLY TIMER will enter the standby state, and “ WEEKLY” will disappear from the LCD. When the ON/OFF TIMER is up, the WEEKLY TIMER will automatically become active.
- Only the time and set temperature with the WEEKLY TIMER are sent with the . Set the WEEKLY TIMER only after setting the operation mode, the airflow rate and the airflow direction ahead of time.
- Turning off the circuit breaker, power failure, and other similar events will render operation of the indoor unit's internal clock inaccurate. Reset the clock. **Page 10**
- can be used only for the time and temperature settings. It cannot be used to go back to the reservation number.



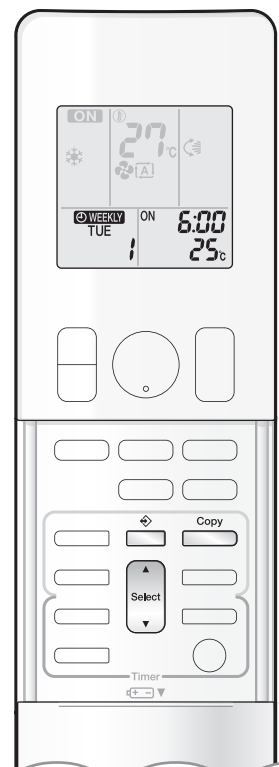

### Copy mode

- A reservation made once can be copied to another day of the week. The whole reservation of the selected day of the week will be copied.

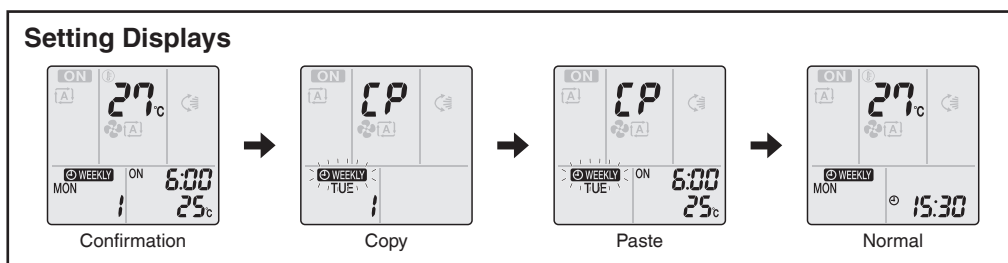
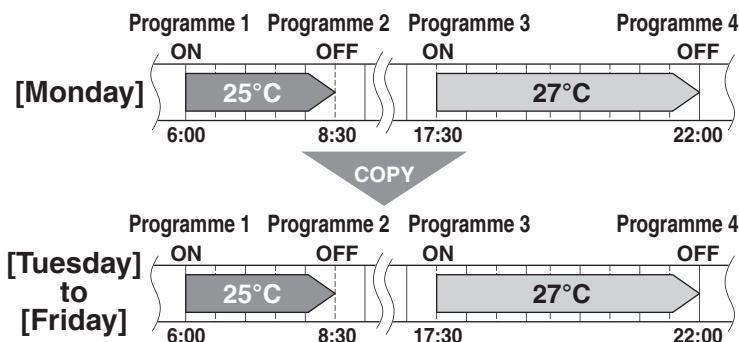

1. Press .
2. Press to confirm the day of the week to be copied.
3. Press .
  - The whole reservation of the selected day of the week will be copied.
4. Press to select the destination day of the week.
5. Press .
  - The reservation will be copied to the selected day of the week. The whole reservation of the selected day of the week will be copied.
  - To continue copying the settings to other days of the week, repeat **STEP 4** and **STEP 5**.
6. Press to complete the setting.
  - “ WEEKLY” is displayed on the LCD and WEEKLY TIMER operation is activated.

## NOTE

### Note on COPY MODE

- The entire reservation of the source day of the week is copied in the copy mode.  
In the case of making a reservation change for any day of the week individually after copying the content of weekly reservations, press and change the settings in the steps of **Setting mode** . **Page 22**



# WEEKLY TIMER Operation

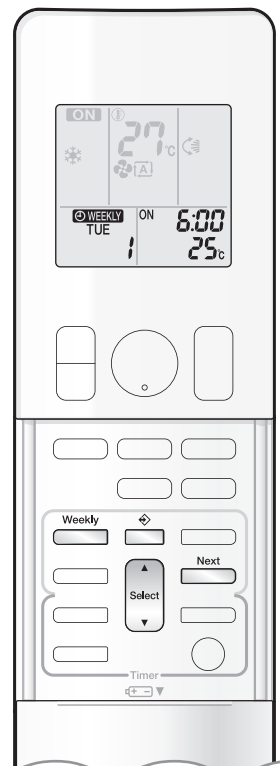

## Confirming a reservation

- The reservation can be confirmed.

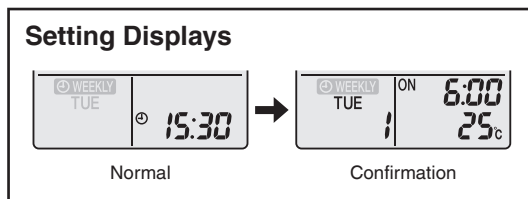

### 1. Press .

- The day of the week and the reservation number of the current day will be displayed.

### 2. Press to select the day of the week and the reservation number to be confirmed.

- Pressing displays the reservation details.
- To change the confirmed reserved settings, select the reservation number and press . The mode is switched to setting mode. Proceed to **Setting mode** STEP 4. [▶Page 22](#)

### 3. Press to exit the confirmation mode.

- “ ” is displayed on the LCD and WEEKLY TIMER operation is activated.
- The TIMER lamp lights orange.

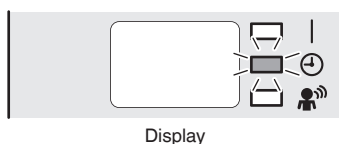

## To deactivate WEEKLY TIMER operation

### Press while “ ” is displayed on the LCD.

- “ ” disappears from the LCD.
- The TIMER lamp goes off.
- To reactivate the WEEKLY TIMER operation, press again.
- If a reservation deactivated with is activated once again, the last reservation mode will be used.

## NOTE

- If not all the reservation settings are reflected, deactivate the WEEKLY TIMER operation once. Then press again to reactivate the WEEKLY TIMER operation.

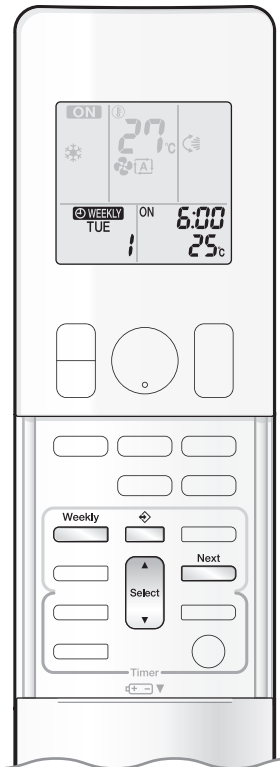

## To delete reservations

### An individual reservation

**1. Press** .

- The day of the week and the reservation number will be displayed.

**2. Press** to select the day of the week and the reservation number to be deleted.

**3. Press** .

- “ WEEKLY” and “ON” or “OFF” blink.

**4. Press** until no icon is displayed.

- Pressing changes the ON/OFF TIMER mode in sequence.
- Selecting “blank” will cancel any reservation you may have.

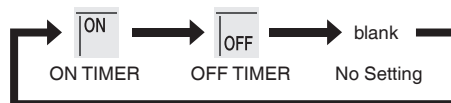

**5. Press** .

- The selected reservation will be deleted.

**6. Press** .

- If there are still other reservations, WEEKLY TIMER operation will be activated.

### Reservations for each day of the week

- This function can be used for deleting reservations for each day of the week.
- It can be used while confirming or setting reservations.

**1. Press** to select the day of the week to be deleted.

**2. Hold** for about 5 seconds.

- The reservation of the selected day of the week will be deleted.

### All reservations

**Hold** for about 5 seconds with the normal display.

- Be sure to direct the remote controller toward the indoor unit and check for a receiving tone.
- This operation cannot be used for the WEEKLY TIMER setting display.
- All reservations will be deleted.

# Care and Cleaning

## ⚠ CAUTION

- Before cleaning, be sure to stop the operation and turn off the circuit breaker.
- Do not touch the aluminum fins of the indoor unit. If you touch those parts, this may cause an injury.

## ■ Quick reference

### Cleaning parts

#### Front panel

- Wipe it with a soft damp cloth.

**If dirty** ▶Page 28

#### Air filter

- Vacuum dust or wash the filter.

**Once every 2 weeks**

▶Page 29

#### Titanium apatite photocatalytic air-purifying filter

- Vacuum dust or replace the filter.

[Cleaning]

**Once every 6 months**

▶Page 30

[Replacement]

**Once every 3 years**

▶Page 30

#### Indoor unit, Outdoor unit and Remote controller

- Wipe them with a soft cloth.

**If dirty**

### Notes on cleaning

For cleaning, do not use any of the following:

- Water hotter than 40°C
- Volatile liquid such as benzene, petrol and thinner
- Polishing compounds
- Rough materials such as a scrubbing brush

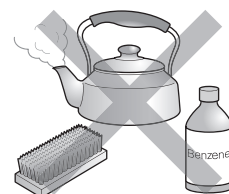

## CAUTION

- When removing or attaching the front panel, stand on a solid, stable base and take care not to fall.
- When removing or attaching the front panel, support the panel securely with your hand to prevent it from falling.

### ■ Front panel

#### 1. Open the front panel.

- Hold the front panel by the panel tabs on the 2 sides and open it.

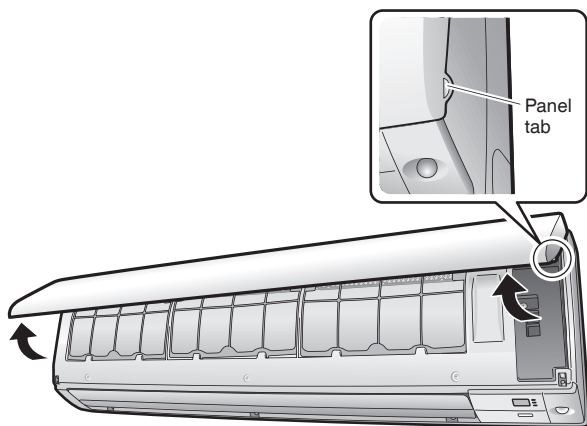

#### 2. Remove the front panel.

- Slide the front panel to either the left or right and pull it toward you. This will disconnect the front panel shaft on one side.

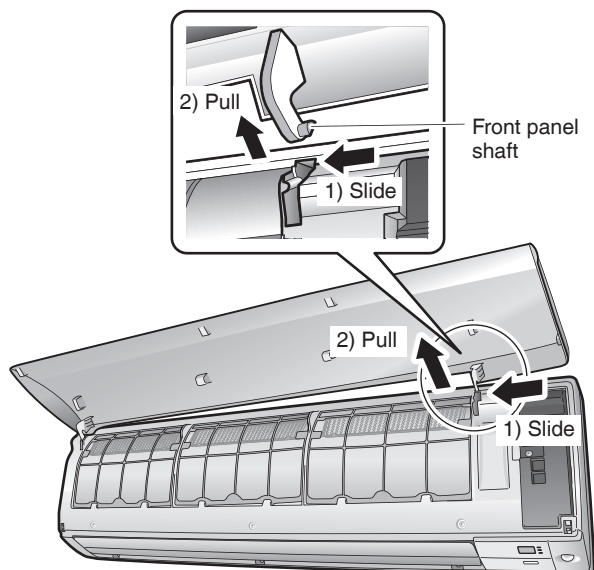

- Disconnect the front panel shaft on the other side in the same manner.

#### 3. Clean the front panel.

- Wipe it with a soft damp cloth.
- Only neutral detergent may be used.
- In case of washing the panel with water, wipe it with a dry soft cloth, and let it dry in the shade after washing.

#### 4. Attach the front panel.

- Align the front panel shaft on the left and right of the front panel with the grooves, then push them all the way in.

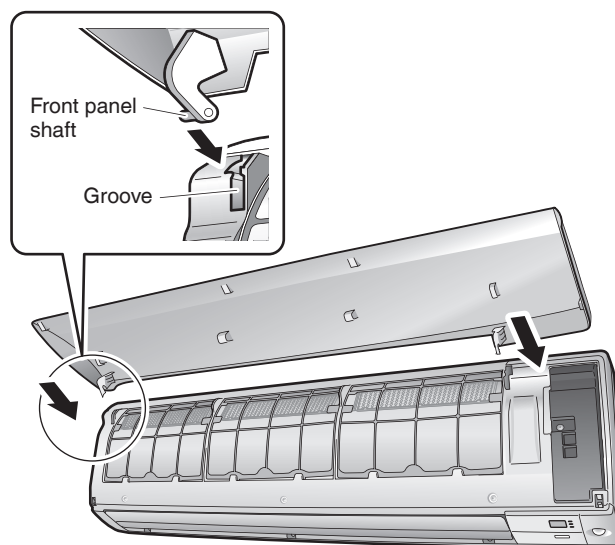

#### 5. Close the front panel slowly.

- Press the front panel at both sides and in the central area.

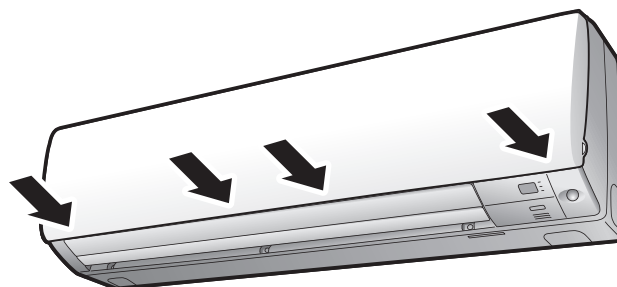

- Make sure that the front panel is securely fixed.

# Care and Cleaning

## ■ Air filter

**1. Open the front panel.** ▶ Page 28

**2. Pull out the air filters.**

- Push the filter tab at the centre of each air filter a little upwards, then pull it down.

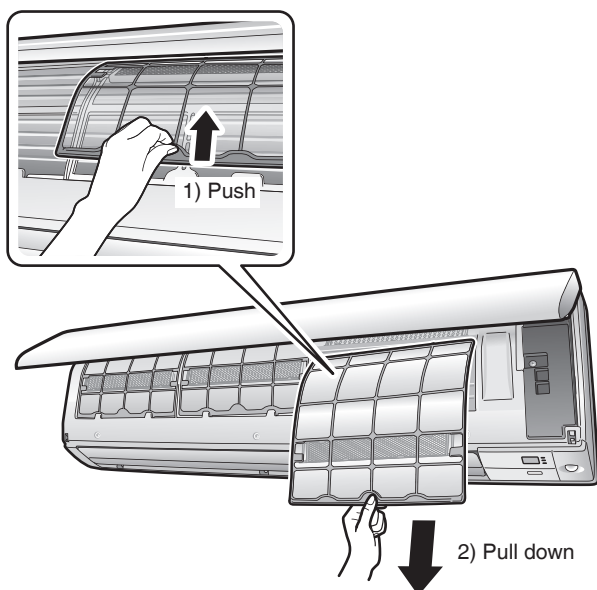

**3. Wash the air filters with water or clean them with a vacuum cleaner.**

- It is recommended to clean the air filters every 2 weeks.

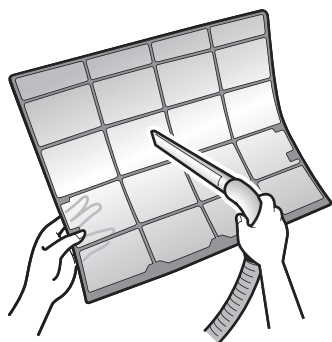

### If the dust does not come off easily

- Wash the air filters with neutral detergent thinned with lukewarm water, then let them dry in the shade.
- Be sure to remove the titanium apatite photocatalytic air-purifying filter. Refer to “**Titanium apatite photocatalytic air-purifying filter**” on the next page.

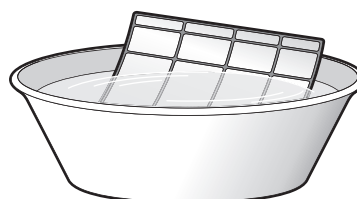

**4. Set the filters as they were.**

**5. Close the front panel slowly.**

▶ Page 28

## ■ Titanium apatite photocatalytic air-purifying filter

**1. Open the front panel and pull out the air filters.** ▶Page 28,29

**2. Take off the titanium apatite photocatalytic air-purifying filters.**

- Hold the recessed parts of the frame and unhook the 4 claws.

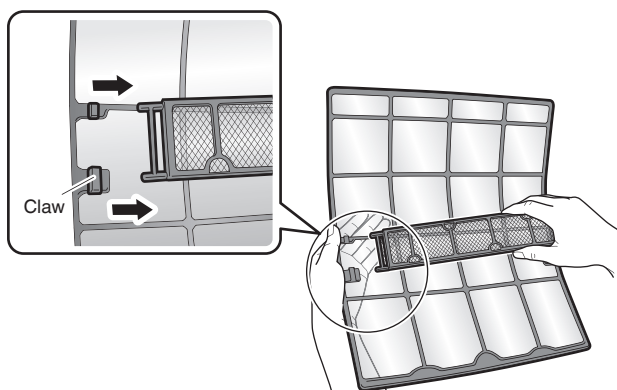

**3. Clean or replace the titanium apatite photocatalytic air-purifying filters.**

### [Cleaning]

**3-1 Vacuum dust, and soak in lukewarm water or water for about 10 to 15 minutes if very dirty.**

- Do not remove the filter from the frame when washing with water.

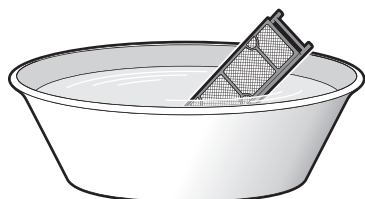

**3-2 After washing, shake off remaining water and let them dry in the shade.**

- Do not wring out the filter to remove water from it.

### [Replacement]

**Remove the filter from the filter frame and attach a new one.**

- Do not throw away the filter frame. Reuse the filter frame when replacing the titanium apatite photocatalytic air-purifying filter.
- When attaching the filter, check that the filter is properly set in the tabs.

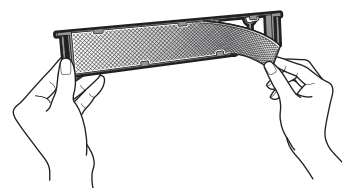

- Dispose of the old filter as non-flammable waste.

**4. Set the titanium apatite photocatalytic air-purifying filters as they were.**

**5. Set the air filters as they were.**

▶Page 29

**6. Close the front panel slowly.**

▶Page 28

### NOTE

- Operation with dirty filters:
  - cannot deodorise the air,
  - cannot clean the air,
  - results in poor heating or cooling,
  - may cause odour.
- Dispose of old filters as non-flammable waste.
- To order a titanium apatite photocatalytic air-purifying filter, contact the dealer where you bought the air conditioner.



Item	Titanium apatite photocatalytic air-purifying filter (without frame) 1 set
Part No.	KAF970A48

# Care and Cleaning

---

## ■ Prior to a long period of non-use

### 1. Operate the FAN mode for several hours on a fine day to dry out the inside.

- Press  and select “”.
- Press  and start the operation.

### 2. After operation stops, turn off the circuit breaker for the room air conditioner.

### 3. Take out the batteries from the remote controller.

## ■ We recommend periodical maintenance

- In certain operating conditions, the inside of the air conditioner may get foul after several seasons of use, resulting in poor performance. It is recommended to have periodical maintenance by a specialist in addition to regular cleaning by the user.
- For specialist maintenance, please contact the dealer where you bought the air conditioner.
- The maintenance cost must be borne by the user.



# FAQ

## Indoor unit

### The flaps do not start swinging immediately.

- The air conditioner is adjusting the position of the flaps. The flaps will start moving soon.

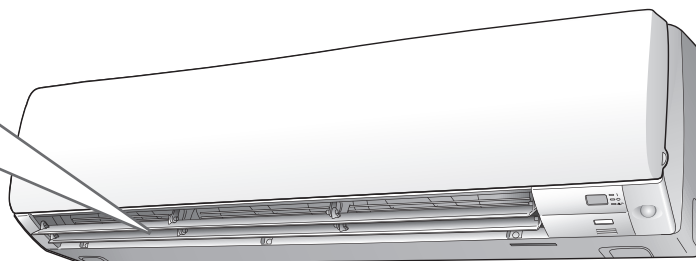

### The air conditioner stops generating airflow during HEAT operation.

- Once the set temperature is reached, the airflow rate is reduced and operation stopped in order to avoid generating a cool airflow. Operation will resume automatically when the indoor temperature falls.

### HEAT operation stops suddenly and a flowing sound is heard.

- The outdoor unit is defrosting. HEAT operation starts after the frost on the outdoor unit has been removed. This can take about 4 to 12 minutes.

### Operation does not start soon.

- When  was pressed soon after operation was stopped.
- When the mode was reselected.
  - This is to protect the air conditioner. You should wait for about 3 minutes.

### Different sounds are heard.

#### ■ A sound like flowing water

- This sound is generated because the refrigerant in the air conditioner is flowing.
- This is a pumping sound of the water in the air conditioner and can be heard when the water is pumped out from the air conditioner during COOL or DRY operation.
- The refrigerant flows in the air conditioner even if the air conditioner is not working when the indoor units in other rooms are in operation.

#### ■ Blowing sound

- This sound is generated when the flow of the refrigerant in the air conditioner is switched over.

#### ■ Ticking sound

- This sound is generated when the cabinet and frame of the air conditioner slightly expand or shrink as a result of temperature changes.

#### ■ Whistling sound

- This sound is generated when refrigerant flows during defrosting operation.

#### ■ Clicking sound during operation or idle time

- This sound is generated when the refrigerant control valves or the electrical parts operate.

#### ■ Clopping sound

- This sound is heard from the inside of the air conditioner when the exhaust fan is activated while the room doors are closed. Open the window or turn off the exhaust fan.

## Outdoor unit

### The outdoor unit emits water or steam.

- In HEAT operation
  - The frost on the outdoor unit melts into water or steam when the air conditioner is in defrosting operation.
- In COOL or DRY operation
  - Moisture in the air condenses into water on the cool surface of the outdoor unit piping and drips.

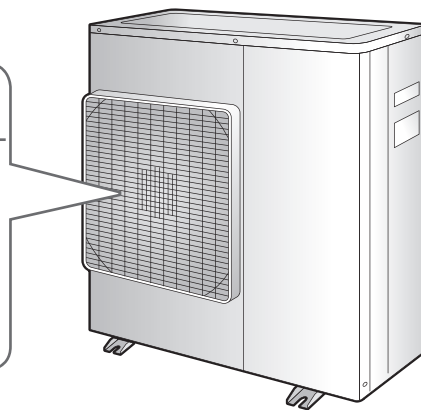

# Troubleshooting

Before making an inquiry or a request for repair, please check the following.  
If the problem persists, consult your dealer.



## Not trouble

These cases are not troubles.



## Check

Please check again before requesting repairs.

### The air conditioner does not operate

Case	Description / what to check
OPERATION lamp is off.	<ul style="list-style-type: none"> <li> • Has the circuit breaker been tripped or the fuse blown?</li> <li>• Is there a power failure?</li> <li>• Are batteries set in the remote controller?</li> </ul>
OPERATION lamp is blinking.	<ul style="list-style-type: none"> <li> • Turn off the power with the circuit breaker and restart operation with the remote controller. If the OPERATION lamp is still blinking, check the error code and consult your dealer. <span style="float: right;">▶ Page 36</span></li> </ul>

### The air conditioner suddenly stops operating

Case	Description / what to check
OPERATION lamp is on.	<ul style="list-style-type: none"> <li> • To protect the system, the air conditioner may stop operating after sudden large voltage fluctuations. It automatically resumes operation in about 3 minutes.</li> </ul>
OPERATION lamp is blinking.	<ul style="list-style-type: none"> <li> • Is there anything blocking the air inlet or air outlet of the indoor unit or outdoor unit? Stop operation and after turning off the circuit breaker, remove the obstruction. Then restart operation with the remote controller. If the OPERATION lamp is still blinking, check the error code and consult your dealer. <span style="float: right;">▶ Page 36</span></li> </ul>

### The air conditioner does not stop operating

Case	Description / what to check
The air conditioner continues operating even after operation is stopped.	<ul style="list-style-type: none"> <li> <ul style="list-style-type: none"> <li>■ <b>Immediately after the air conditioner is stopped</b> <ul style="list-style-type: none"> <li>• The outdoor unit fan continues rotating for about another 1 minute to protect the system.</li> </ul> </li> <li>■ <b>While the air conditioner is not in operation</b> <ul style="list-style-type: none"> <li>• When the outdoor temperature is high, the outdoor unit fan may start rotating to protect the system.</li> </ul> </li> </ul> </li> </ul>

### The room does not cool down / warm up

Case	Description / what to check
Air does not come out.	<ul style="list-style-type: none"> <li> <ul style="list-style-type: none"> <li>■ <b>In HEATING operation</b> <ul style="list-style-type: none"> <li>• The air conditioner is warming up. Wait for about 1 to 4 minutes.</li> <li>• During defrosting operation, hot air does not flow out of the indoor unit.</li> </ul> </li> <li>■ <b>When the air conditioner operates immediately after the circuit breaker is turned on</b> <ul style="list-style-type: none"> <li>• The air conditioner is preparing to operate. Wait for about 3 to 15 minutes.</li> </ul> </li> </ul> </li> </ul>
Air does not come out / Air comes out.	<ul style="list-style-type: none"> <li> <ul style="list-style-type: none"> <li>■ <b>Is the airflow rate setting appropriate?</b> <ul style="list-style-type: none"> <li>• Is the airflow rate setting low, such as "Indoor unit quiet" or "1"? Increase the airflow rate setting.</li> </ul> </li> <li>■ <b>Is the set temperature appropriate?</b></li> <li>■ <b>Is the adjustment of the airflow direction appropriate?</b></li> </ul> </li> </ul>
Air comes out.	<ul style="list-style-type: none"> <li> <ul style="list-style-type: none"> <li>• Is there any furniture directly under or beside the indoor unit?</li> <li>• Is the air conditioner in ECONO operation or OUTDOOR UNIT QUIET operation? <span style="float: right;">▶ Page 18</span></li> </ul> </li> <li>• Are the air filters dirty?</li> <li>• Is there anything blocking the air inlet or air outlet of the indoor unit or outdoor unit?</li> <li>• Is a window or door open?</li> <li>• Is an exhaust fan turning?</li> </ul>

### Mist comes out

Case	Description / what to check
Mist comes out of the indoor unit.	<input checked="" type="checkbox"/> • This happens when the air in the room is cooled into mist by the cold airflow during COOL or other operation.

### Remote controller

Case	Description / what to check
The unit does not receive signals from the remote controller or has a limited operating range.	<input checked="" type="checkbox"/> • The batteries may be exhausted. Replace both batteries with new dry batteries AAA.LR03 (alkaline). For details, refer to “ <b>Preparation Before Operation</b> ”. ▶Page 9 <input type="checkbox"/> • Signal communication may be disabled if an electronic-starter-type fluorescent lamp (such as inverter-type lamps) is in the room. Consult your dealer if that is the case. <input type="checkbox"/> • The remote controller may not function correctly if the transmitter is exposed to direct sunlight.
LCD is faint, is not working, or the display is erratic.	<input checked="" type="checkbox"/> • The batteries may be exhausted. Replace both batteries with new dry batteries AAA.LR03 (alkaline). For details, refer to “ <b>Preparation Before Operation</b> ”. ▶Page 9
Other electric devices start operating.	<input checked="" type="checkbox"/> • If the remote controller activates other electric devices, move them away or consult your dealer.

### Air has an odour

Case	Description / what to check
The air conditioner gives off an odour.	<input checked="" type="checkbox"/> • The room odour absorbed in the unit is discharged with the airflow. We recommend you to have the indoor unit cleaned. Please consult your dealer.

### Others

Case	Description / what to check
The air conditioner suddenly starts behaving strangely during operation.	<input type="checkbox"/> • The air conditioner may malfunction due to lightning or radio. If the air conditioner malfunctions, turn off the power with the circuit breaker and restart the operation with the remote controller.
HEAT operation cannot be selected, even though the unit is heat pump model.	<input type="checkbox"/> • Check that the jumper (J8) has not been cut. If it has been cut, contact your dealer.
The ON/OFF TIMER does not operate according to the settings.	<input checked="" type="checkbox"/> • Check if the ON/OFF TIMER and the WEEKLY TIMER are set to the same time. Change or deactivate the settings in the WEEKLY TIMER. ▶Page 21



### Notes on the operating conditions

- If operation continues under any conditions other than those listed in the table,
  - A safety device may activate to stop the operation.
  - Dew may form on the indoor unit and drip from it when COOL or DRY operation is selected.

Mode	Operating conditions
DRY	Outdoor temperature : -10-46°C Indoor temperature : 18-32°C Indoor humidity : 80% max.
COOL	Outdoor temperature : -10-46°C Indoor temperature : 18-32°C Indoor humidity : 80% max.
HEAT	Outdoor temperature : -15-24°C Indoor temperature : 10-30°C

# Troubleshooting

## ■ Call your dealer immediately

### WARNING

**When an abnormality (such as a burning smell) occurs, stop operation and turn off the circuit breaker.**

- Continued operation in an abnormal condition may result in troubles, electric shocks or fire.
- Consult the dealer where you bought the air conditioner.

**Do not attempt to repair or modify the air conditioner by yourself.**

- Incorrect work may result in electric shocks or fire.
- Consult the dealer where you bought the air conditioner.

**If one of the following symptoms takes place, call your dealer immediately.**

- The power cord is abnormally hot or damaged.
- An abnormal sound is heard during operation.
- The circuit breaker, a fuse, or the earth leakage circuit breaker cuts off the operation frequently.
- A switch or a button often fails to work properly.
- There is a burning smell.
- Water leaks from the indoor unit.

Turn off the circuit breaker and call your dealer.



### ■ After a power failure

- The air conditioner automatically resumes operation in about 3 minutes. You should just wait for a while.

### ■ Lightning

- If there is a risk lightning could strike in the neighbourhood, stop operation and turn off the circuit breaker to protect the system.

## ■ Disposal requirements

- Dismantling of the unit, handling of the refrigerant, oil and other parts, should be done in accordance with the relevant local and national regulations.

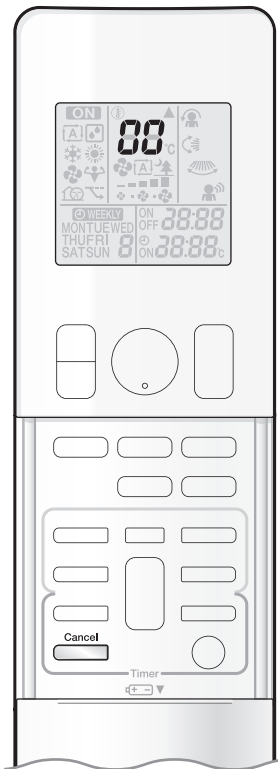

## ■ Fault diagnosis by remote controller

- The remote controller can receive relevant error codes from the indoor unit.

**1.** When  is held down for about 5 seconds, “00” blinks in the temperature display section.

**2.** Press  repeatedly until a continuous beep is produced.

- The code indication changes as shown below, and notifies you with a long beep.

	CODE	MEANING
SYSTEM	00	NORMAL
	UA	INDOOR-OUTDOOR UNIT COMBINATION FAULT
	U0	REFRIGERANT SHORTAGE
	U2	DROP VOLTAGE OR MAIN CIRCUIT OVERVOLTAGE
	U4	FAILURE OF TRANSMISSION (BETWEEN INDOOR UNIT AND OUTDOOR UNIT)
INDOOR UNIT	A1	INDOOR PCB DEFECTIVENESS
	A5	HIGH PRESSURE CONTROL OR FREEZE-UP PROTECTOR
	A6	FAN MOTOR FAULT
	C4	FAULTY HEAT EXCHANGER TEMPERATURE SENSOR
	C9	FAULTY SUCTION AIR TEMPERATURE SENSOR
OUTDOOR UNIT	EA	COOLING-HEATING SWITCHING ERROR
	E1	CIRCUIT BOARD FAULT
	E5	OL STARTED
	E6	FAULTY COMPRESSOR START UP
	E7	DC FAN MOTOR FAULT
	E8	OVERCURRENT INPUT
	F3	HIGH TEMPERATURE DISCHARGE PIPE CONTROL
	F6	HIGH PRESSURE CONTROL (IN COOLING)
	H0	SENSOR FAULT
	H6	OPERATION HALT DUE TO FAULTY POSITION DETECTION SENSOR
	H8	DC CURRENT SENSOR FAULT
	H9	FAULTY SUCTION AIR TEMPERATURE SENSOR
	J3	FAULTY DISCHARGE PIPE TEMPERATURE SENSOR
	J6	FAULTY HEAT EXCHANGER TEMPERATURE SENSOR
L3	ELECTRICAL PARTS HEAT FAULT	
L4	HIGH TEMPERATURE AT INVERTER CIRCUIT HEATSINK	
L5	OUTPUT OVERCURRENT	
P4	FAULTY INVERTER CIRCUIT HEATSINK TEMPERATURE SENSOR	

## NOTE

- A short beep and 2 consecutive beeps indicate non-corresponding codes.
- To cancel the code display, hold  down for about 5 seconds. The code display also clears if no button is pressed for 1 minute.

## Memo



# Quick Reference

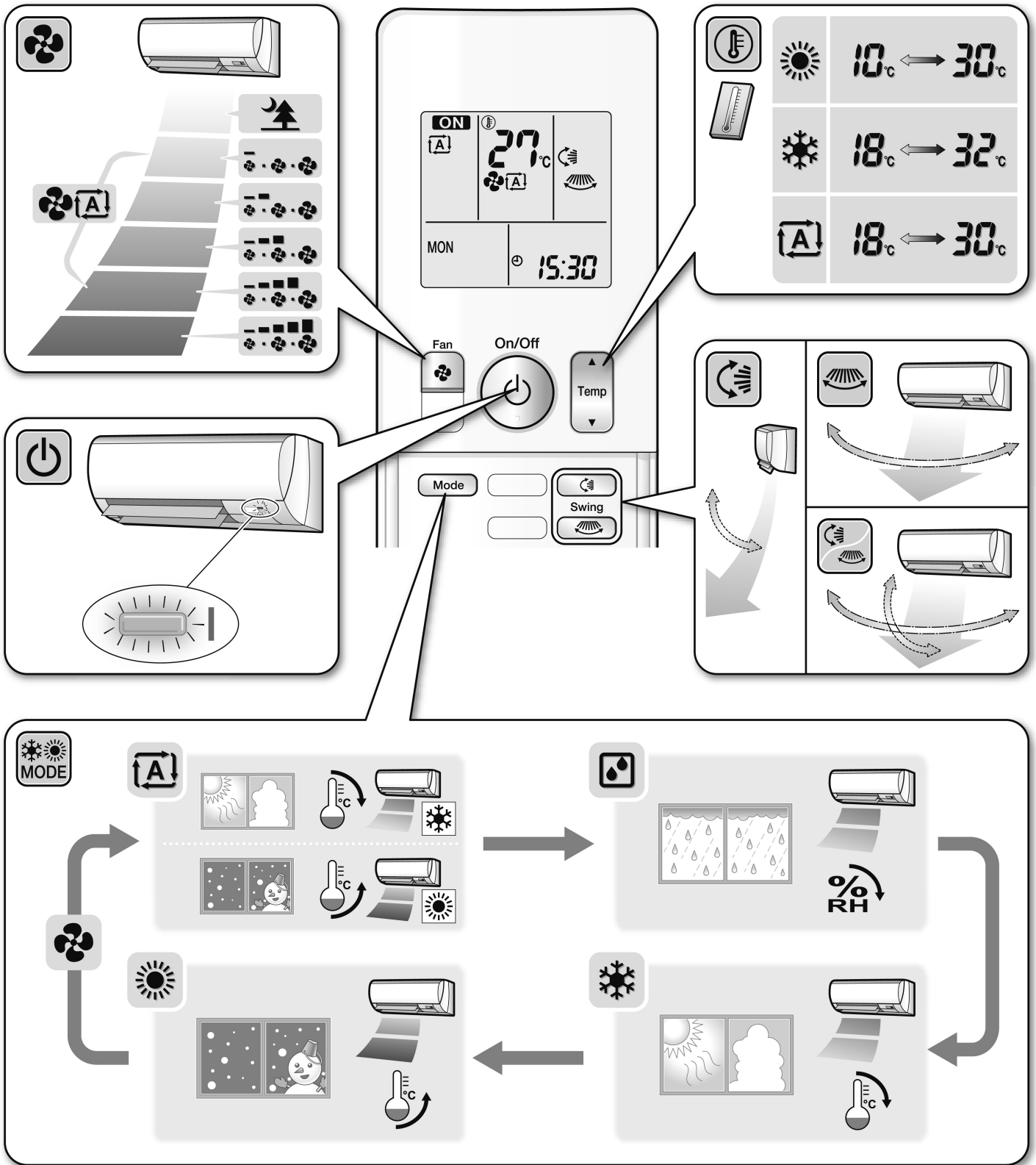

## DAIKIN INDUSTRIES, LTD.

Head office:  
 Umeda Center Bldg., 2-4-12, Nakazaki-Nishi,  
 Kita-ku, Osaka, 530-8323 Japan

Tokyo office:  
 JR Shinagawa East Bldg., 2-18-1, Konan,  
 Minato-ku, Tokyo, 108-0075 Japan  
<http://www.daikin.com>



The two-dimensional bar code is a manufacturing code.

3P372379-3 | M13B346 (1406) HT