

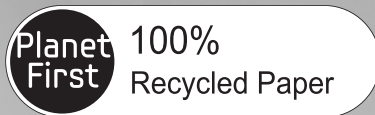

AQV09T\* Series  
AQV12T\* Series  
AQV18T\* Series

# Air Conditioner user & installation manual



This manual is made with 100% recycled paper.

imagine the possibilities

Thank you for purchasing this Samsung product.

**SAMSUNG**

# Features of your new air conditioner Contents

## Cool Summer Offer

On those hot sweltering summer days and long restless nights, there is no better escape from the heat than the cool comforts of home. Your new air conditioner brings an end to exhausting hot summer days and lets you rest. Beat the heat with your own air conditioner this summer.

## Cost Efficient System

Your new air conditioner not only provides cooling power in the summer, but also can be an efficient heating method in the winter with the advanced "Heat pump" system. Now, meet year-round needs with one air conditioner.

## Look for Everywhere

The elegant and harmonious design gives priority to the esthetics of your space and complements any of your existing interior décor. With its soft color and rounded-edge shape, the new air conditioner adds class to any room. Enjoy what your air conditioner offers both functionally and esthetically.

## good'sleep function

good'sleep function will allow you to have deep, good night's sleep by adjusting the temperature, fan speed and air flow direction.

## DRED Enabled (Demand Response Enabled Device)

This unit has the facility to be remotely controlled by the power Supply Authority.

## USING PARTS

|                                       |    |
|---------------------------------------|----|
| Safety precautions.....               | 3  |
| Checking before use.....              | 9  |
| Checking the name of the parts.....   | 10 |
| Checking the remote controller.....   | 11 |
| Basic function.....                   | 13 |
| Adjusting the air flow direction..... | 15 |
| Using the Turbo function.....         | 15 |
| good'sleep mode.....                  | 16 |
| Setting the Current time.....         | 17 |
| Setting the On/Off timer.....         | 17 |
| Using the Smart Saver function.....   | 19 |
| Using the Quiet function.....         | 19 |
| Using the Auto Clean function.....    | 20 |
| Cleaning the air conditioner.....     | 21 |
| Maintaining the air conditioner.....  | 23 |
| Troubleshooting.....                  | 24 |

## INSTALLATION PARTS







|   |    |
|---|----|
| Safety precautions.....   | 26 |
| Choosing the installation location.....                             | 27 |
| Accessories.....  | 30 |
| Fixing the installation plate.....                                  | 31 |
| Connecting the assembly cable.....                                  | 32 |
| Installing and connecting the assembly pipe of the indoor unit..... | 34 |
| Evacuating the indoor unit.....                                     | 35 |
| Cutting or extending the pipe.....                                  | 35 |
| Installing and connecting the drain hose of the indoor unit.....    | 37 |
| Changing direction of the drain hose.....                           | 38 |
| Installing and connecting the drain hose of the outdoor unit.....   | 39 |
| Evacuating the connected pipes.....                                 | 39 |
| Performing the gas leak tests.....                                  | 42 |
| Fixing the indoor unit in place.....                                | 43 |
| Fixing the outdoor unit in place.....                               | 43 |
| Final Check and Trial Operation.....                                | 44 |
| Pump down procedure (when removing the product).....                | 44 |
| How to connect your extended power cables.....                      | 45 |

## Safety precautions

Before using your new air conditioner, please read this manual thoroughly to ensure that you know how to safely and efficiently operate the extensive features and functions of your new appliance.

Because the following operating instructions cover various models, the characteristics of your air conditioner may differ slightly from those described in this manual. If you have any questions, call your nearest contact center or find help and information online at [www.samsung.com](http://www.samsung.com).

### Important safety symbols and precautions:

|  |   |   |                           |
|--|---|---|---------------------------|
|  <b>WARNING</b> | Hazards or unsafe practices that may result in <b>severe personal injury or death.</b>          |   |                           |
|  <b>CAUTION</b> | Hazards or unsafe practices that may result in <b>minor personal injury or property damage.</b> |   |                           |
|                 | Follow directions.  |  | Cut-off the power supply. |
|                 | Do NOT attempt.   |  | Do NOT disassemble.       |
|                 | Make sure the machine is grounded to prevent electric shock.                                    |   |                           |

### FOR INSTALLATION

### **WARNING**

 **Use the power line with the power specifications of the product or higher and use the power line for this appliance only. In addition, do not use an extension line.**

- ▶ Extending the power line may result in electric shock or fire.
- ▶ Do not use an electric transformer. It may result in electric shock or fire.
- ▶ If the voltage/frequency/rated current condition is different, it may cause fire.

**The installation of this appliance must be performed by a qualified technician or service company.**

- ▶ Failing to do so may result in electric shock, fire, explosion, problems with the product, or injury and may also void warranty on the installed product.

**Install a Isolation Switch next to the Air Conditioner (but not on the panels of the Air Conditioner)and circuit breaker dedicated to the air conditioner.**

- ▶ Failing to do so may result in electric shock or fire.

**Fix the outdoor unit firmly so that the electric part of the outdoor unit is not exposed.**

- ▶ Failing to do so may result in electric shock, fire, explosion, problems with the product.

## Safety precautions

- ⊘ **Do not install this appliance near a heater, inflammable material. Do not install this appliance in a humid, oily or dusty location, in a location exposed to direct sunlight and water (rain drops). Do not install this appliance in a location where gas may leak.**
  - ▶ This may result in electric shock or fire.**Never install the outdoor unit in a location such as on a high external wall where it could fall.**
  - ▶ If the outdoor unit falls, it may result in injury, death or property damage.
- ⚡ **This appliance must be properly grounded. Do not ground the appliance to a gas pipe, plastic water pipe, or telephone line.**
  - ▶ Failure to do so may result in electric shock, fire, and explosion.
  - ▶ Make sure to use a socket-outlet with ground.

### FOR INSTALLATION

### ⚠ CAUTION

- ❗ **Install your appliance on a level and hard floor that can support its weight.**
  - ▶ Failing to do so may result in abnormal vibrations, noise, or problems with the product.**Install the draining hose properly so that water is drained correctly.**
  - ▶ Failing to do so may result in water overflowing and property damage. Avoid adding drain to waste pipes as odours may arise in the future.**When installing the outdoor unit, make sure to connect the draining hose so that draining is performed correctly.**
  - ▶ The water generated during the heating operation by the outdoor unit may overflow and result in property damage.  
In particular, in winter, if a block of ice falls, it may result in injury, death or property damage.

### FOR POWER SUPPLY

### ⚠ WARNING

- ❗ **When the circuit breaker is damaged, contact your nearest service center.**
- ⊘ **Do not pull or excessively bend the power line. Do not twist or tie the power line. Do not hook the power line over a metal object, place a heavy object on the power line, insert the power line between objects, or push the power line into the space behind the appliance.**
  - ▶ This may result in electric shock or fire.

## FOR POWER SUPPLY | ⚠ CAUTION

- ⓘ **When not using the air conditioner for a long period of time or during a thunder/lightning storm, cut the power at the circuit breaker.**
  - ▶ Failing to do so may result in electric shock or fire.

## FOR USING | ⚠ WARNING

- ❗ **If the appliance is flooded, please contact your nearest service center.**
  - ▶ Failing to do so may result in electric shock or fire.
- If the appliance generates a strange noise, a burning smell or smoke, cut-off the power supply immediately and contact the nearest service center.**
  - ▶ Failing to do so may result in electric shock or fire.
- In the event of a gas leak (such as propane gas, LP gas, etc.), ventilate immediately without touching the power line. Do not touch the appliance or power line.**
  - ▶ Do not use a ventilating fan.
  - ▶ A spark may result in an explosion or fire.
- To reinstall the air conditioner, please contact your nearest service center.**
  - ▶ Failing to do so may result in problems with the product, water leakage, electric shock, or fire.
  - ▶ A delivery service for the product is not provided. If you reinstall the product in another location, additional construction expenses and an installation fee will be charged.
  - ▶ Especially, when you wish to install the product in an unusual location such as in an industrial area or near the seaside where it is exposed to the salt in the air, please contact your nearest service center.
  - ▶ Please refer to your warranty cards for terms and conditions.
- ⊘ **Do not touch the circuit breaker with wet hands.**
  - ▶ This may result in electric shock.
- Do not turn the air conditioner off with the circuit breaker while it is operating.**
  - ▶ Turning the air conditioner off and then on again with the circuit breaker may cause a spark and result in electric shock or fire.
- After unpacking the air conditioner, keep all packaging materials well out of the reach of children, as packaging materials can be dangerous to children.**
  - ▶ If a child places a bag over its head, it may result in suffocation.

## Safety precautions

---

- ⊘ **Do not insert your fingers or foreign substances into the outlet when the air conditioner is operating.**
  - ▶ Take special care that children do not injure themselves by inserting their fingers into the product.
- Do not touch the air flow blade with your hands or fingers during the heating operation.**
  - ▶ This may result in electric shock or burns.
- Do not insert your fingers or foreign substances into the air inlet/outlet of the air conditioner.**
  - ▶ Take special care that children do not injure themselves by inserting their fingers into the product.
- Do not strike or pull the air conditioner with excessive force.**
  - ▶ This may result in fire, injury, or problems with the product.

### FOR USING

### ⚠ WARNING

- ⊘ **Do not place an object near the outdoor unit that allows children to climb onto the machine.**
  - ▶ This may result in children seriously injuring themselves.
- Do not use this air conditioner for long periods of time in badly ventilated locations or near infirm people.**
  - ▶ Since this may be dangerous due to a lack of oxygen, Open a window at least once an hour.
- ⊘ **If any foreign substance such as water has entered the appliance, cut-off the power supply and contact the nearest service center.**
  - ▶ Failing to do so may result in electric shock or fire.
- ⊘ **Do not attempt to repair, disassemble, or modify the appliance yourself.**
  - ▶ Do not use any fuse (such as cooper, steel wire, etc.) other than the standard fuse.
  - ▶ Failing to do so may result in electric shock, fire, problems with the product, or injury.

## FOR USING

## ⚠ CAUTION

- ❗ **Do not place objects or devices under the indoor unit.**
  - ▶ Water dripping from the indoor unit may result in fire or property damage. (example electrical appliances)
- Check that the installation frame of the outdoor unit is not broken at least once a year.**
  - ▶ Failing to do so may result in injury, death or property damage.
- Max current is measured according to IEC standard for safety and current is measured according to ISO standard for energy efficiency.**
- ⊘ **Do not stand on top of the appliance or place objects (such as laundry, lighted candles, lighted cigarettes, dishes, chemicals, metal objects, etc.) on the appliance.**
  - ▶ This may result in electric shock, fire, problems with the product, or injury.
- Do not operate the appliance with wet hands.**
  - ▶ This may result in electric shock.
- Do not spray volatile material such as insecticide onto the surface of the appliance.**
  - ▶ As well as being harmful to humans, it may also result in electric shock, fire or problems with the product.
- Do not drink the water from the air conditioner.**
  - ▶ The water may be harmful to humans.
- Do not apply a strong impact to the remote controller and do not disassemble the remote controller.**
- Do not touch the pipes connected with the product.**
  - ▶ This may result in burns or injury.
- Do not use this air conditioner to preserve precision equipment, food, animals, plants or cosmetics, or for any other unusual purposes.**
  - ▶ This may result in property damage.
  - ▶ Please refer to your warranty cards for terms and conditions.
- Avoid directly exposing humans, animals or plants from the air flow from the air conditioner for long periods of time.**
  - ▶ This may result in harm to humans, animals or plants.

## Safety precautions

---

- ⊘ This appliance is not intended for use by persons (including children) with reduced physical, sensory or mental capabilities, or lack of experience and knowledge, unless they have been given supervision or instruction concerning use of the appliance by a person responsible for their safety. Children should be supervised to ensure that they do not play with the appliance.

### FOR CLEANING

### ⚠ WARNING

---

- ⊘ Do not clean the appliance by spraying water directly onto it. Do not use benzene, thinner or alcohol to clean the appliance.
  - ▶ This may result in discoloration, deformation, damage, electric shock or fire.**Before cleaning or performing maintenance, cut-off the power supply and wait until the fan stops.**
  - ▶ Failing to do so may result in electric shock or fire.

### FOR CLEANING

### ⚠ CAUTION

---

- ⓘ **Take care when cleaning the surface of the heat exchanger of the outdoor unit since it has sharp edges.**
  - ▶ This should be done by a qualified technician please contact your installer or service center.
- ⊘ **Do not clean the inside of the air conditioner by yourself.**
  - ▶ For cleaning inside the appliance, contact your nearest service center.
  - ▶ When cleaning the internal filter, refer to the descriptions in the 'Cleaning the air conditioner' section.
  - ▶ Failure to do may result in damage, electric shock or fire.



# Checking before use

## Operation ranges

The table below indicates the temperature and humidity ranges the air conditioner can be operated within. Refer to the table for efficient use.

| Mode    | Indoor temperature | Outdoor temperature | Indoor humidity               |
|---------|--------------------|---------------------|-------------------------------|
| Cooling | 16°C~32°C          | -10°C~46°C          | Relative humidity 80% or less |
| Heating | 27°C or less       | -15°C~24°C          | -                             |
| Dry     | 18°C~32°C          | -10°C~46°C          | -                             |

- ▶ If the air conditioner operates in cooling mode for long period of time in high humidity area, dew may be formed.
- ▶ If the outdoor temperature goes down to -5°C, heating capacity may decrease as much as 60%~70% of specified capacity according to the using conditions.

## Maintaining your air conditioner

### Internal protections via the unit control system

- ▶ This internal protection operates if an internal fault occurs in the air conditioner.

| Type               | Description  |
|--------------------|--|
| Against cold air   | The internal fan will be off to prevent cold air when the heat pump is heating.  |
| Defrost cycle      | The internal fan will be off to defrost ice when the heat pump is heating.<br>Vertical air flow blade will be closed during defrost cycle and it will open again during heating operation after defrost cycle. |
| Protect compressor | The air conditioner does not start operating immediately to help protect the compressor of the outdoor unit after it has been started.   |



- If the heat pump is operating in Heat mode, defrost cycle is actuated to help remove frost from an outdoor unit that may have deposited at low temperatures.  
The internal fan is switched off automatically and restarted only after the defrost cycle is completed.



- A Samsung-branded air conditioning unit installed in an area which is not easily accessible (including without limitation roofs or positions above 2.4 metres for the outdoor unit) may require additional costs for labour and access equipment as may be mandated by occupational health and safety requirements. Such costs are to be borne by you should service or maintenance (including service or maintenance covered by your warranty or by a consumer guarantee) be required.

# Checking the name of the parts

Your air conditioner may slightly look different from illustration shown below depending on your model.

## Main parts

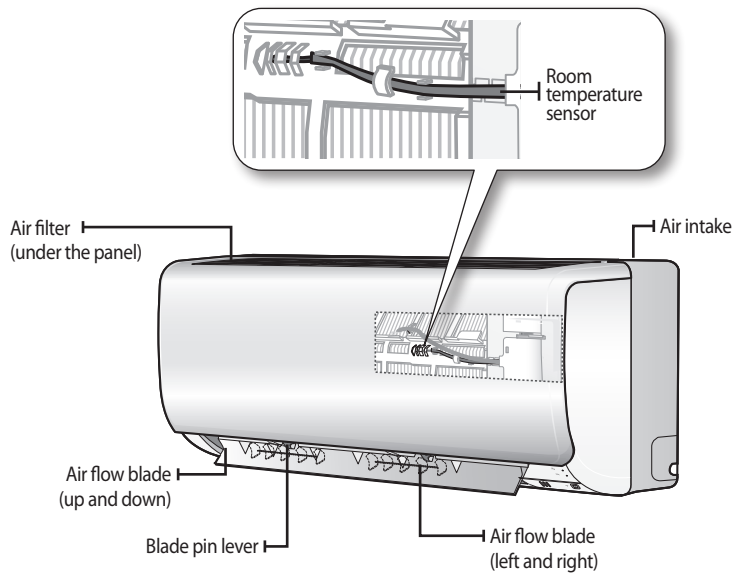

## Display

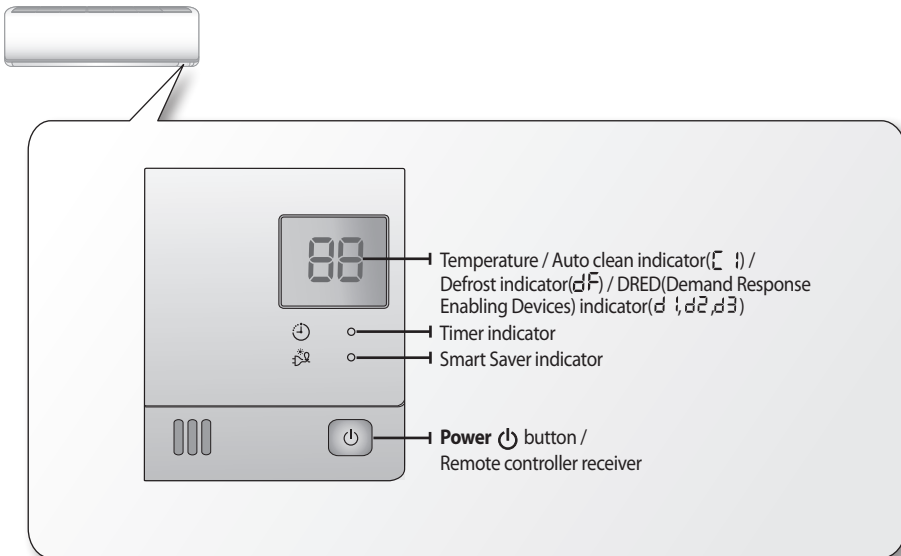

# Checking the remote controller

- Point the remote controller towards the remote controller receiver of the indoor unit.
- When you properly press the button on the remote controller, you will hear beep sound from the indoor unit and a transmit indicator (📶) appears on the remote controller display.

## Remote controller buttons

\* Before using the functions of the remote controller, you should set the current time. (Refer to p.17)

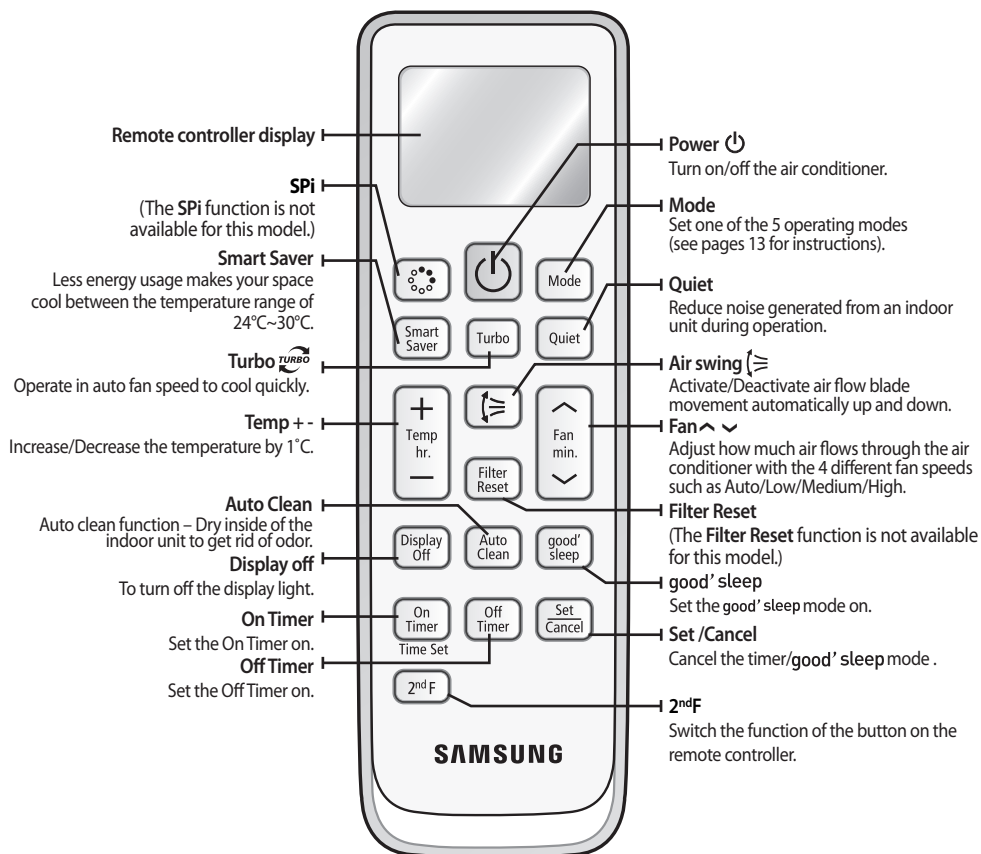

### Time set

Set the current time.



- When you press [2<sup>nd</sup>F] button, the 2<sup>nd</sup>F indicator will be displayed on the remote controller and you can change the functions on the remote controller as listed below.

On Timer ► Time Set function.

If you select the function under the button while the function of the button is switched by 2<sup>nd</sup>F button, the 2<sup>nd</sup>F function is canceled.

# Checking the remote controller

## Remote controller display

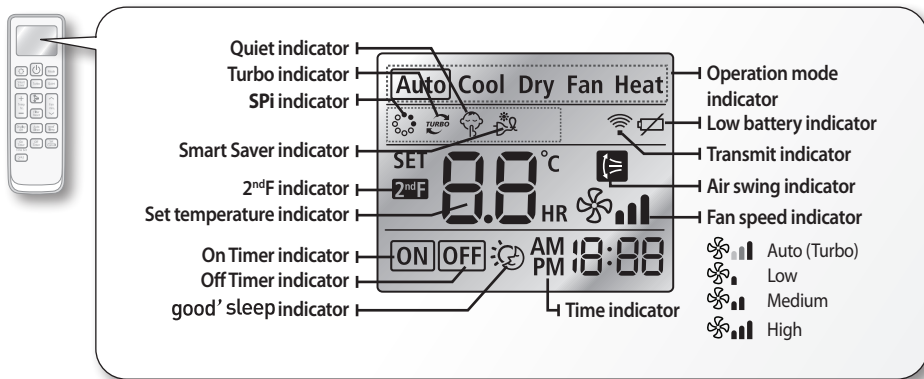

- Make sure that the water does not get to the remote controller.
- SPI function is displayed on the remote controller display but not supported in this model.

## Battery changing time

When the battery is exhausted, (🔋) will be displayed in the remote controller display. When the icon appears, change the batteries. The remote controller requires two 1.5V AAA type batteries.

## Storing the remote controller

When you do not use the remote controller for long time, remove the batteries from the remote controller and store it.

## Inserting the batteries



1. Push the lever as arrow indicates on the rear side of the remote controller and pull up.



2. Insert two AAA batteries. Check and match the "+" and "-" signs accordingly. Make sure you have inserted the batteries in correct position.

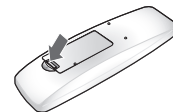

3. Close the cover by place it back to its original position. You should hear click sound when the cover is locked properly.



- The signal may not be received well of electronic lighting style fluorescent lamps such as inverter fluorescent lamps are in the same space.
- If other electrical products operate by the remote controller, call your nearest contact center.

# Basic function

Basic operation is an operation mode that can be selected by pressing the **Mode** button.

## Auto

In Auto mode, the air conditioner will automatically set the temperature and fan speed depending on the room temperature detected by the room temperature sensor.

## Cool

In Cool mode, the air conditioner will cool your room. You can adjust the temperature and the fan speed to feel cooler in hot season.

- If current outside temperatures are much higher than the selected indoor temperature, it may take time to bring the inner temperature to the desired coolness.
- Quiet mode (🌀, 📶, 🗣️) makes the noise quieter during the operation of the indoor unit in the Cool mode.

## Dry

The air conditioner in Dry mode acts like a dehumidifier by removing moisture from the indoor air. Dry mode makes the air feel refreshing in a humid climate.

To activate the Dry mode, set temperature **on the remote controller** should be lower than indoor room temperature.

## Fan

Fan mode can be selected to circulate your room. Fan mode will be helpful to refresh the stale air in your room.

## Heat

The air conditioner heats as well as cools. Warm your room with this versatile appliance in the cold of winter.

- Fan may not operate for about 3~5 minutes at the beginning to prevent any cold blasts while the air conditioner is warming up.
- Quiet mode (🌀, 📶, 🗣️) makes the noise quieter during the operation of the indoor unit in the Heat mode.
- Since the air conditioner heats the room by taking heat energy from outdoor air, the heating capacity may decrease when outdoor temperature is extremely low.  
Use an additional heating appliance in combination with the air conditioner if you feel the air conditioner heats insufficiently.

## DEMAND RESPONSE MODE (DRM 1, 2, 3)

This air conditioner is equipped with a Demand Response unit which will respond to a signal sent by the power supply utility during emergency conditions.

- During a Demand Response Event, the indoor and outdoor unit will be operated according to DRM mode (DRM 1, 2, 3) and indoor unit will show "d1", "d2", "d3" on the display.
- In case customer has set swing mode prior to DRM 1, 2, 3 being initiated, Air flow blades will continue to swing.



# Basic function

## AIR CONDITIONER DEMAND RESPONSE MODES

| Operational instruction (OI) | Demand response mode (DRM)* | Description of operation in this mode  | Mandatory for compliance with this Standard (AS/NZS 4755.3.1) |
|------------------------------|-----------------------------|--|---|
| OI 1                         | DRM 1                       | Indoor fan and Compressor off  | Yes   |
| OI 2                         | DRM 2                       | The air conditioner continues to cool or heat during the demand response event, but the electrical energy consumed by the air conditioner in a half hour period is not more than 50% of the total electrical energy that would be consumed if operating at the rated capacity in a half hour period. | No  |
| OI 3                         | DRM 3                       | The air conditioner continues to cool or heat during the demand response event, but the electrical energy consumed by the air conditioner in a half hour period is not more than 75% of the total electrical energy that would be consumed if operating at the rated capacity in a half hour period. | No  |







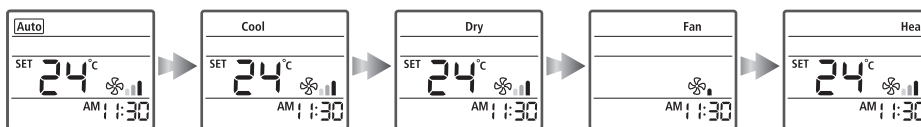



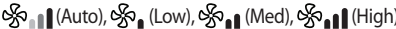

Press the  button to turn on the air conditioner.

Press the  button to set the operating mode.

- Each time you press the **Mode** button, the mode will change in order of Auto, Cool, Dry, Fan and Heat.

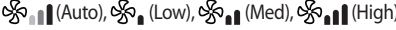

Press the  button to set the desired fan speed.

|      |  |
|------|--|
| Auto |  (Auto)  |
| Cool |  (Auto),  (Low),  (Med),  (High) |
| Dry  |  (Auto)   |
| Fan  |  (Low),  (Med),  (High)   |
| Heat |  (Auto),  (Low),  (Med),  (High) |

Press the  button to adjust the temperature.

|      |  |
|------|--|
| Auto | You can adjust the desired temperature by 1°C within the range of 16°C~30°C. |
| Cool | You can adjust the desired temperature by 1°C within the range of 16°C~30°C. |
| Dry  | You can adjust the desired temperature by 1°C within the range of 18°C~30°C. |
| Fan  | Temperature adjustment is not possible.                                      |
| Heat | You can adjust the desired temperature by 1°C within the range of 16°C~30°C. |



- Dry mode is only available in the cooling mode.

# Adjusting the air flow direction

Air flow can be directed to your desired position.

## Vertical air flow

Air flow blades move up and down.

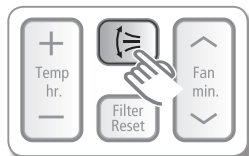

Press the **Air swing** button on the remote controller.

- ▶ Air swing indicator will be on the remote controller display and air flow blades move up and down continuously to circulate the air.
- ▶ Press the **Air swing** button on the remote controller again, to keep the air flow direction in a constant position.
- ▶ If you adjust the vertical air flow blade manually, it may not close completely when you turn off the air conditioner

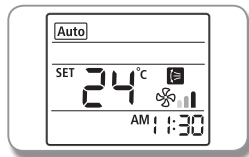

- Adjusting the air flow direction is not available in good'sleep mode while it is in cool mode.
- However, you can adjust the air flow direction in good'sleep mode while it is in heat mode.

## Horizontal air flow

Make sure one of the blade pin lever that stick out of the air flow blades are not broken.

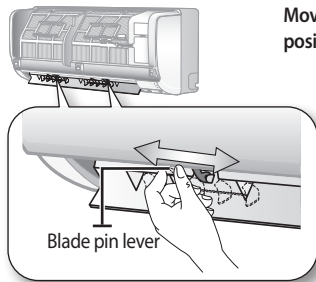

Move the blade pin lever left or right to keep the air flow direction in a constant position you prefer.



- Be extremely careful with your fingers while adjusting the Horizontal air flow direction. There is a potential risk of personal injury when the unit is mishandled.

# Using the Turbo function

Turbo function will be helpful to cool your room quickly and effectively.

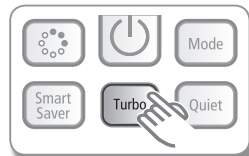

Press the **Turbo** button on the remote controller during Cool mode.

- ▶ Turbo indicator appears on the remote controller display and the air conditioner operates in Turbo function for 30 minutes.

**Cancel** Press the **Turbo** button once again.

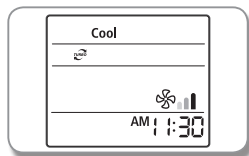

- Turbo function is only available in Cool mode.
- If you press the **Mode** button while the Turbo function is on, it will cancel the function.
- Temperature/Fan speed cannot be adjusted while using this function.

# good'sleep mode

Before using good' sleep mode, set the current time.(For setting current time, refer to the page 17.)

For a comfortable sleep, the air conditioner will operate it Fall asleep ▷ Sound sleep ▷ Wake up from **good'sleep** mode.

## When the air conditioner is on and in cool/heat mode

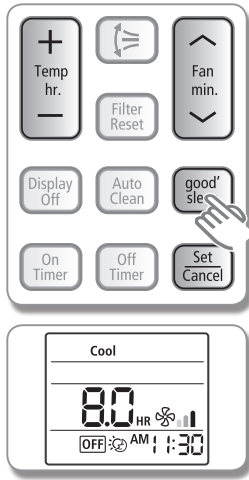

1. Press the **good'sleep** button on the remote controller.
  - ▶ **good'sleep** indicator appears and Off timer indicator starts blinking on the remote controller display.
2. Press the **good'sleep** button to set the time.
  - ▶ You can set the time in half hourly unit from 30 minutes ~ 3 hours and hour unit from 3 hours ~ 12 hours.
  - ▶ Operating hour can be set from minimum 30 minutes to maximum 12 hours.
  - ▶ Default operation hour is set to 8 hours.
3. Press the **Set/Cancel** button to active it.
  - ▶ Off timer indicator stops blinking and reserved time will be displayed for 3 seconds. Then the air conditioner operates in good'sleep mode.
  - ▶ If you don't press **Set/Cancel** button within 10 seconds after pressing the **good'sleep** button, the air conditioner will return to previous status. Check Off timer indicator on the remote controller display and ⌚ indicator on the indoor unit.

**Cancel** Press the **Set/Cancel** button once again.

|  |   |
|--|---|
|  | You can set the desired temperature by 1°C in the range of 16°C~30°C.   |
|  | Fan speed will be adjusted automatically according to the <b>good'sleep</b> mode.<br>However, If you select <b>good'sleep</b> mode while heating operation is on, you can adjust fan speed. |
|  | When the <b>good'sleep</b> mode is on.<br>In Cool mode: Air flow direction will be adjusted automatically.<br>In Heat mode: Adjusting air flow direction is available.                      |

## Temperature and fan speed changes in good'sleep mode

- Fall asleep: Eases you into sleep by dropping the temperature.
- Sound sleep: Relaxes your body and raises your temperature slightly.
- Wake up from **good'sleep** mode: Allows you to wake up from comfortable intermittent air and it makes you feel refreshed.



- Set Off timer in **good'sleep** mode over 5 hours. You fell disturbed sleep if the **good'sleep** is set too short or long because the default is set to 8-hour-operation.
- If the **good'sleep** mode is set less than 4 hours, the operation will stop at the same time.  
If the **good'sleep** mode is set over 5 hours, it will run as Wake up stage from the last one hour before it stops.
- Recommended set temperature is between 25°C~27°C for cooling and 21°C~23°C for heating.



## Setting the Current time

Before using the functions of the air-conditioner, set the current time.

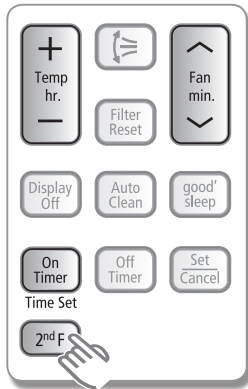

### 1. Press 2<sup>nd</sup>F button

▶ 2<sup>nd</sup>F indicator appears on the remote controller display.

### 2. Press Time Set button to set the current time

▶ AM or PM indicator will blink and you can set the time by pressing **Temp hr.** + or - button for hour and **Fan min.** ^ v button for minute.

### 3. Press Time Set button again to active it.

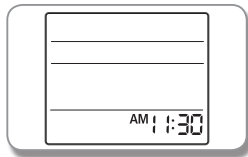

## Setting the On/Off timer



- Check the current time on the remote controller before using this function.
- The default time is 12 AM on the remote controller. The current time is reset to default time after changing the batteries .

You can set the air conditioner to turn on/off automatically at desired time.

**Setting On timer while the air conditioner is off / Off timer while the air conditioner is on**

### Setting On timer

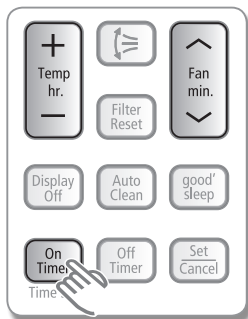

### 1. Press the On Timer/Off Timer button.

▶ On/Off timer indicator will blink on the remote controller display.

### 2. Press the Temp hr. + or - button and Fan min. ^ v button to set the time.

▶ You can set the time in hourly units from 1 hour ~ 12hours according to AM, PM and in minute units from 1minute ~ 59minutes.

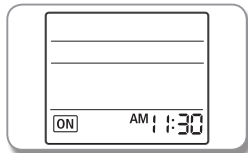

# Setting the On/Off timer

## Setting Off timer

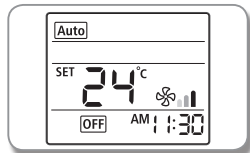
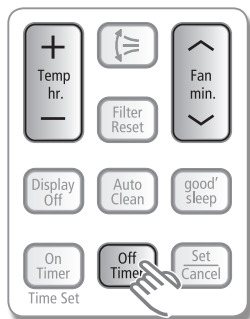

3. Press the **Set/Cancel** button to active it.

- ▶ On timer indicator stops blinking and reserved time will be displayed for 3 seconds.
- ▶ If you don't press **Set/Cancel** button within 10 seconds after selecting the time the air conditioner will return to previous status. Check On timer or Off timer indicator on the remote controller display and indicator on the indoor unit.

**Cancel** Press the **Set/Cancel** button once again.

### Additional options available in On/Off time mode (When the remote controller is on)

|  |  |
|--|--|
|  | You can select from Auto/Cool/Dry/Fan/Heat.                |
|  | You can adjust the fan speed in Cool/Fan/Heat mode.        |
|  | You can adjust the temperature in Auto/Cool/Dry/Heat mode. |

## Setting on timer and off timer simultaneously



Follow the same process for setting on timer and off timer.



- On timer and Off timer setting time should be different from each other.
- Press the **Set/Cancel** button on the remote controller while timer combination is on. Both of the On and Off timer will be canceled and the indicator will disappear.



- Only the latest setting timer will be applied between the On Timer/Off Timer and good'sleep Off timer functions.

## Using the Smart Saver function

This function will set the temperature range limit while the air conditioner is operating in Cool mode.



Press the **Smart Saver** button on the remote controller while the air conditioner is operating in Cool mode.

- ▶ Smart Saver indicator and air swing indicator (≡) appears automatically on the remote controller display.  
The air flow blades move up and down.
- ▶ If the current set temperature is lower than 24°C, it will automatically raise to 24°C.

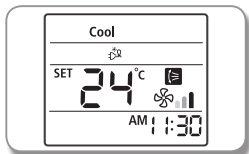

**Cancel** Press the **Smart Saver** button once again.



- Smart Saver function is only available in Cool mode.
- When Smart Saver function is activated, temperature range will be limited to 24°C~30°C.
- If the desired temperature is lower than 24°C, turn off the Smart Saver function by pressing the **Smart Saver** button again.
- Temperature/Fan speed can also be adjusted (see page 14 for instructions).
- Air flow can be adjusted manually (see page 15 for instruction).
- If you press the **Mode** button while the Smart Saver function is on, it will cancel the function.

## Using the Quiet function

You can reduce the noise generated from an indoor unit.



Press the **Quiet** button on the remote controller while the air conditioner is operating in Cool/Heat mode.

- ▶ Quiet indicator appears on the remote controller display.
- ▶ The indoor unit will operate more quietly.

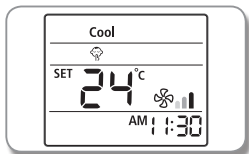

**Cancel** Press the **Quiet** button once again.



- If using a multi system, this function will work only when the Quiet function is set on all operated indoor units.

# Using the Auto Clean function

Auto clean function will minimise the moisture inside of the indoor unit. Activate this function to help provide you with clean air.

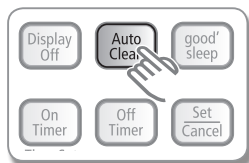

Press the **Auto Clean** button.

## When the air conditioner is turned off,

- ▶ The Auto clean indicator on the indoor unit display appears and the Auto clean function runs.

## When the air conditioner is turned on,

- ▶ After stopping the air conditioner operation, the Auto clean indicator on the indoor unit display appears and the Auto clean function runs.

※ Auto Clean time can vary, depending on the previously used mode.

**Auto(cool), Cool, Dry mode** : approximately 30 minutes.

**Auto(heat), Heat, Fan mode** : approximately 15 minutes.

**Cancel** Press the **Auto clean** button once again.



- During the auto clean function, indoor fan will continue to run and air flow blade will remain open to expel ambient air.

# Cleaning the air conditioner



**CAUTION**

- Make sure to turn off the power of the indoor unit and cut-off the power supply before cleaning the air conditioner.

## Cleaning the indoor unit

- ▶ Wipe the surface of the unit with a slightly damp micro fiber cloth when needed.



**NOTE**

- Contact the service center when you clean the indoor unit heat exchanger because it needs to be disassembled.
- Since the panel of the indoor unit is easily scratched, you should use a micro fiber cloth to clean the panel. When you use the micro fiber cloth, slightly dampen the cloth and remove any debris on the cloth to avoid scratches.

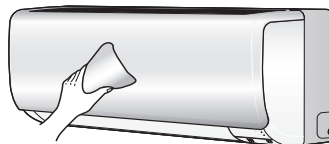

**CAUTION**

- Do not clean the display using alkaline detergent.
- Do not use sulfuric acid, hydrochloric acid, organic solvents (such as thinner, kerosene and acetone etc.) to clean the surface of the product or put any stickers on it. They may damage the surface of the air conditioner.

## Cleaning the outdoor unit heat exchanger

- ▶ When dust accumulates on the heat exchanger, it may decrease cooling performance. Therefore, clean it regularly.
- ▶ Spray water to clean the dust.



**NOTE**

- If it is difficult to clean the outdoor unit heat exchanger on your own, contact service center.



**CAUTION**

- Be careful with the sharp edges on the outdoor unit heat exchanger.

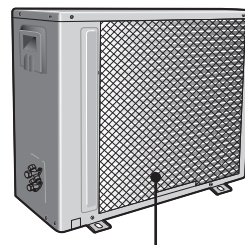

**Heat exchanger**

(Illustration may differ slightly depending on the models)

## Opening the panel

Tightly grab bottom of grill panel and pull up. Then slightly lift the panel up.

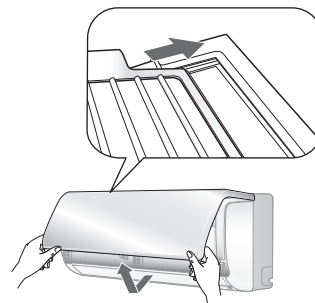

# Cleaning the air conditioner

## Removing the Air filter

Grab the handle and lift it up. Then, pull the Air filter towards you and slide it down.

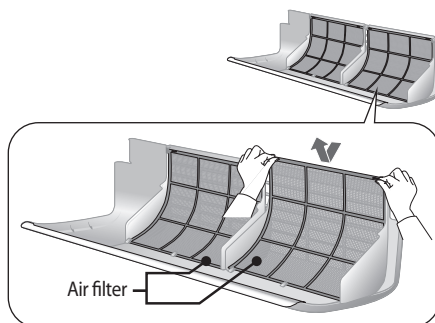

## Cleaning the air filter

Washable foam based air filter captures large particles from the air. The filter is cleaned with a vacuum or by hand washing.

Open the panel and put the Air filter out.

Clean the Air filter with a vacuum cleaner or soft brush. If dust is too heavy, rinse it with running water.

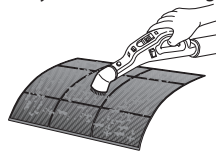

Insert the Air filter back in its original position and close the front panel.

Dry the Air filter in a ventilated area.

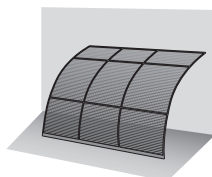

- Clean the Air filter every 2 weeks. Cleaning term may differ depending on the usage and environmental conditions. In dusty area, clean it once a week.
- If the Air filter dries in a confined (or humid) area, odors may generate. If it occurs, re-clean and dry it in a well-ventilated area.

# Maintaining the air conditioner

If the air conditioner will not be used for an extended period of time, dry the air conditioner to maintain it in best condition.

1. Dry the air conditioner thoroughly by operating in Fan mode for 3 to 4 hours and cut-off the power supply. There may be internal damage if moisture is left in components.
2. Before using the air conditioner again, dry the inner components of the air conditioner again by running in Fan mode for 3 to 4 hours. This helps remove odors which may have generated from dampness.

## Periodical checks

Refer to the following chart to maintain the air conditioner properly.

| Type         | Description  | Every 2 weeks | Every 3 months | Every 4 months | Once a year |
|--------------|--|---------------|----------------|----------------|-------------|
| Indoor unit  | Clean the Full HD filter (1)                                     | ●             |                |                |             |
|              | Clean the condensate drain pan (2)                               |               |                |                | ●           |
|              | Thoroughly clean the heat exchanger (2)                          |               |                |                | ●           |
|              | Clean the cross fan (2)  |               |                | ●              |             |
|              | Clean the condensate drain pipe (2)                              |               |                | ●              |             |
|              | Replace the remote controller batteries (1)                      |               |                |                | ●           |
| Outdoor unit | Clean the heat exchanger on the outside of the unit (2)          |               |                | ●              |             |
|              | Clean the heat exchanger on the inside of the unit (2)           |               |                |                | ●           |
|              | Clean the electric components with jets of air (2)               |               |                |                | ●           |
|              | Verify that all the electric components are firmly tightened (2) |               |                |                | ●           |
|              | Clean the fan (2)  |               |                |                | ●           |
|              | Verify that all the fan assembly is firmly tightened (2)         |               |                |                | ●           |
|              | Clean the condensate drain pan (2)                               |               |                |                | ●           |

● : This check mark requires checking the indoor/outdoor unit periodically. Follow the description to maintain the air conditioner properly.



- (1) The described operations should be performed more frequently if the area of installation is very dusty.
- (2) These operations must always be performed by qualified personnel. For more detailed information, see the installation part in the manual.

# Troubleshooting

Refer to the following chart if the air conditioner operates abnormally. This may save time and unnecessary expenses.

| PROBLEM   | SOLUTION  |
|---|---|
| The air conditioner does not work at all.               | <ul style="list-style-type: none"><li>• Check power status and then operate the air conditioner again.</li><li>• Plug in or switch on the circuit breaker and then operate the air conditioner again.</li><li>• Ensure Isolator is switch on.</li><li>• Check if you have set the Off Timer. Operate the air conditioner again by pressing the <b>Power</b> button.</li></ul>   |
| The temperature adjustment is not working.              | <ul style="list-style-type: none"><li>• Check if you have selected Fan/Turbo mode. In these modes, desired temperature is set to auto and you cannot adjust the temperature.</li></ul>  |
| Cool/Warm air does not come out of the air conditioner. | <ul style="list-style-type: none"><li>• Check if the set temperature is higher(during Cool mode)/ lower(during Heat mode) than the current temperature. Press the <b>Temp +</b> or - button on the remote controller to change the set temperature.</li><li>• Check if the Air filter is blocked by dirt. If there is a lot of dust on the Air filter, cooling(heating) performance may decrease. Clean them frequently.</li><li>• Check if the outdoor unit is covered or installed near the obstacle. Take the cover off and take the obstacle away.</li><li>• Check if the air conditioner is operating in defrost mode. When the ice formed in winter or the outdoor temperature is too low, the air conditioner operates in defrost mode automatically. In defrost mode, indoor fan stops and warm air does not come out.</li><li>• If the doors or windows are open, it may cause bad cooling (heating) performance. Close the doors and windows.</li><li>• Check if the air conditioner has just been turned on after stopping cooling or heating operation. In this case, just a fan will run to protect the outdoor unit compressor.</li><li>• Check if the pipe length is too long. When the pipe length exceeds maximum allowable pipe length, cooling (heating) performance may decrease.</li></ul> |
| Air flow adjustment is not working.                     | <ul style="list-style-type: none"><li>• Check if you have selected <b>good'sleep</b> mode. In this mode, you cannot adjust the air flow direction. (If the <b>good'sleep</b> mode is operating in Heat mode, you can adjust the air flow direction.)</li></ul>  |





| PROBLEM  | SOLUTION  |
|--|---|
| Fan speed adjustment is not working.                       | <ul style="list-style-type: none"> <li>Check if you have selected Auto/Dry/Turbo/good's sleep mode. In these mode, fan speed is set to Auto and you cannot adjust the fan speed.</li> </ul>   |
| Remote controller is not working.                          | <ul style="list-style-type: none"> <li>Check if your batteries are depleted.</li> <li>Make sure nothing is blocking your remote controller sensor.</li> <li>Check that there are strong lighting apparatus near the air conditioner. Strong light which comes from fluorescent bulbs or neon signs may interrupt the electric waves.</li> </ul>             |
| Timer function does not set.                               | <ul style="list-style-type: none"> <li>Check if you press the <b>Set/Cancel</b> button on the remote controller after you have set the time.</li> </ul>   |
| The indicator is blinking continuously.                    | <ul style="list-style-type: none"> <li>Press the <b>Power</b>  button or disconnect the power plug/switch off the auxiliary power switch. If the indicator is still blinking, contact the service center.</li> </ul>   |
| Odors permeate in the room during operation.               | <ul style="list-style-type: none"> <li>Check if the appliance is running in a smoky area. Ventilate the room or operate the air conditioner in Fan mode for 1~2 hours. (We do not use smelly components in the air conditioner.)</li> <li>Check the Drains have been cleared Regular Maintenance.</li> </ul>  |
| Error is indicated.  | <ul style="list-style-type: none"> <li>When an indoor unit indicator blinks, contact the nearest service center. Please ensure the error code is passed onto the service center when booking the service call.</li> </ul>   |
| Noise is generated.  | <ul style="list-style-type: none"> <li>Depending on the status of the air conditioner usage, noise can be heard when refrigerant flow movement changes. It is normal.</li> </ul>  |
| Smoke is generated from the outdoor unit.                  | <ul style="list-style-type: none"> <li>If may not be a fire but it can be a steam generated by the defrost operation from outdoor heat exchanger during Heat mode in winter.</li> </ul>   |
| Water is dropping from the outdoor unit piping connection. | <ul style="list-style-type: none"> <li>Water may be generated because of the temperature difference. It is normal.</li> </ul>   |
| Indoor unit display indicates "d 1, d2, d3"                | <ul style="list-style-type: none"> <li>This is not a defect. If the air conditioner receives a Demand Response signal from the power supply utility, then the compressor and fans will be operated according to DRM mode(DRM 1, 2,3). The indoor unit display will indicate "d 1, d2, d3".</li> </ul> <p>※ see page 14 for more details about DRM mode.</p> |



## INSTALLATION PARTS

※ In this manual, you may find model names written in simplified forms as indicated in following table.

| Model Names | Included Models              | Remark                         |
|-------------|------------------------------|--------------------------------|
| AQV**T**    | AQV09T**, AQV12T**, AQV18T** | Grouping was done by series.   |
| **09**      | AQV09T**                     | Grouping was done by capacity. |
| **12**      | AQV12T**                     |                                |
| **18**      | AQV18T**                     |                                |

## Safety precautions

Carefully follow the precautions listed below because they are essential to guarantee the safety of the equipment.

- Always disconnect the air conditioner from the power supply before servicing it or accessing its internal components.
- Verify that installation and testing operations are performed by qualified personnel.
- Verify that the air conditioner is not installed in an easily accessible area.

### General information

- ▶ Carefully read the content of this manual before installing the air conditioner and store the manual in a safe place in order to be able to use it as reference after installation.
- ▶ For maximum safety, installers should always carefully read the following warnings.
- ▶ Store the operation and installation manual in a safe location and remember to hand it over to the new owner if the air conditioner is sold or transferred.
- ▶ This manual explains how to install an indoor unit with a split system with two SAMSUNG units. The use of other types of units with different control systems may damage the units and invalidate the warranty. The manufacturer shall not be responsible for damages arising from the use of non compliant units.
- ▶ This product has been determined to be in compliance with the Low Voltage Directive (2006/95/EC), and the Electromagnetic Compatibility Directive (2004/108/EC) of the European Union.
- ▶ The manufacturer shall not be responsible for damage originating from unauthorized changes or the improper connection of electric and requirements set forth in the "Operating limits" table, included in the manual, shall immediately invalidate the warranty.
- ▶ The air conditioner should be used only for the applications for which it has been designed: the indoor unit is not suitable to be installed in areas used for laundry.
- ▶ Do not use the units if damaged. If problems occur, switch the unit off and disconnect it from the power supply.
- ▶ In order to help prevent electric shocks, fires or injuries, always stop the unit, disable the protection switch and contact SAMSUNG's technical support if the unit produces smoke, if the power cable is hot or damaged or if the unit is very noisy.
- ▶ Always remember to inspect the unit, electric connections, refrigerant tubes and protections regularly. These operations should be performed by qualified personnel only.
- ▶ The unit contains moving parts, which should always be kept out of the reach of children.
- ▶ Do not attempt to repair, move, alter or reinstall the unit. If performed by unauthorized personnel, these operations may cause electric shocks or fires.
- ▶ Do not place containers with liquids or other objects on the unit.
- ▶ All the materials used for the manufacture and packaging of the air conditioner are recyclable.
- ▶ The packing material and exhaust batteries of the remote controller(optional) must be disposed of in accordance with current laws.
- ▶ The air conditioner contains a refrigerant that has to be disposed of as special waste. At the end of its life cycle, the air conditioner must be disposed of in authorized centers or returned to the retailer so that it can be disposed of correctly and safely.



## Installing the unit

---

**IMPORTANT:** When installing the unit, always remember to connect first the refrigerant tubes, then the electrical lines.

Always disassemble the electric lines before the refrigerant tubes.

- ▶ Upon receipt, inspect the product to verify that it has not been damaged during transport. If the product appears damaged, **DO NOT INSTALL** it and immediately report the damage to the carrier or retailer (if the installer or the authorized technician has collected the material from the retailer.)
- ▶ After completing the installation, always carry out a functional test and provide the instructions on how to operate the air conditioner to the user.
- ▶ Do not use the air conditioner in environments with hazardous substances or close to equipment that release free flames to avoid the occurrence of fires, explosions or injuries.
- ▶ To help prevent injury when accidentally touching the indoor unit fan, install the indoor unit at least 2.5m above the floor.
- ▶ The air conditioner should be used only for the applications for which it has been designed : the indoor unit is not suitable to be installed in areas used for laundry.
- ▶ Our units must be installed in compliance with the spaces indicated in the installation manual to ensure either accessibility from both sides or ability to perform routine maintenance and repairs. The units' components must be accessible and that can be disassembled in conditions of complete safety either for people or things.  
For this reason, where it is not observed as indicated into the Installation Manual, the cost necessary to reach and repair the unit (in safety, as required by current regulations in force) with slings, trucks, scaffolding or any other means of elevation won't be considered in-warranty and charged to end user.

## Power supply line, fuse or circuit breaker

---

- ▶ Always make sure that the power supply is compliant with current safety standards. Always install the air conditioner in compliance with current local safety standards.
- ▶ Always verify that a suitable grounding connection is available.
- ▶ Verify that the voltage and frequency of the power supply comply with the specifications and that the installed power is sufficient to ensure the operation of any other domestic appliance connected to the same electric lines.
- ▶ Always verify that the cut-off and protection switches are suitably dimensioned.
- ▶ Verify that the air conditioner is connected to the power supply in accordance with the instructions provided in the wiring diagram included in the manual.
- ▶ Always verify that electric connections (cable entry, section of leads, protections...) are compliant with the electric specifications and with the instructions provided in the wiring scheme.  
Always verify that all connections comply with the standards applicable to the installation of air conditioners.

# Choosing the installation location

---

## Indoor unit

- ▶ For Wi-Fi Air-conditioner installation, select indoor unit location near to wireless router.  
In case Wi-Fi signal strength weakened , Smart APP may be disconnected depending on the Wi-Fi signal strength.
- ▶ Where airflow is not blocked.
- ▶ Where cool air can be distributed throughout the room.
- ▶ Install the refrigerant piping length and the height difference of both indoor and outdoor units as indicated in the installation diagram.
- ▶ Wall that prevents vibration and is strong enough to hold the product weight.
- ▶ Out of the direct sunlight .
- ▶ 1m or more away from the TV or radio (to prevent the screen from being distorted or noise from being generated).
- ▶ As far away as possible from the fluorescent and incandescent lights (so that the remote controller can be operated well).
- ▶ A place where the air filter can be replaced easily.
- ▶ Don't install directly above electronics equipment as leaking water may cause damage if not serviced. (eg. Computers, TV, etc).



# Choosing the installation location

## Outdoor Unit

- ▶ Where it is not exposed to strong wind
- ▶ Well ventilated and dustless places
- ▶ Where possible keep out of sunlight and rain
- ▶ Where neighbors are not annoyed by operation sound or hot air
- ▶ Solid wall or support that prevents vibration and is strong enough to hold the product weight
- ▶ Where there is no risk of flammable gas leakage
- ▶ When installing the unit at a high place be sure to fix the unit legs
- ▶ 3m or more away from the TV or radio (to prevent the screen from being distorted or noise from being generated)
- ▶ Install the unit horizontally
- ▶ Place where drained water does not become any problem.
- ▶ Place with no plants (especially climbing plants) and where small animal can not access.
- ▶ Outdoor unit should not be place higher than 2.4m or directly under eaves for accessibility for service and OH&S reasons.



- Avoid the following places to prevent malfunction of the unit
  - Where there is machine oil
  - Salty environment such as seaside areas
  - Where sulfide gas exists
  - Other special atmosphere areas

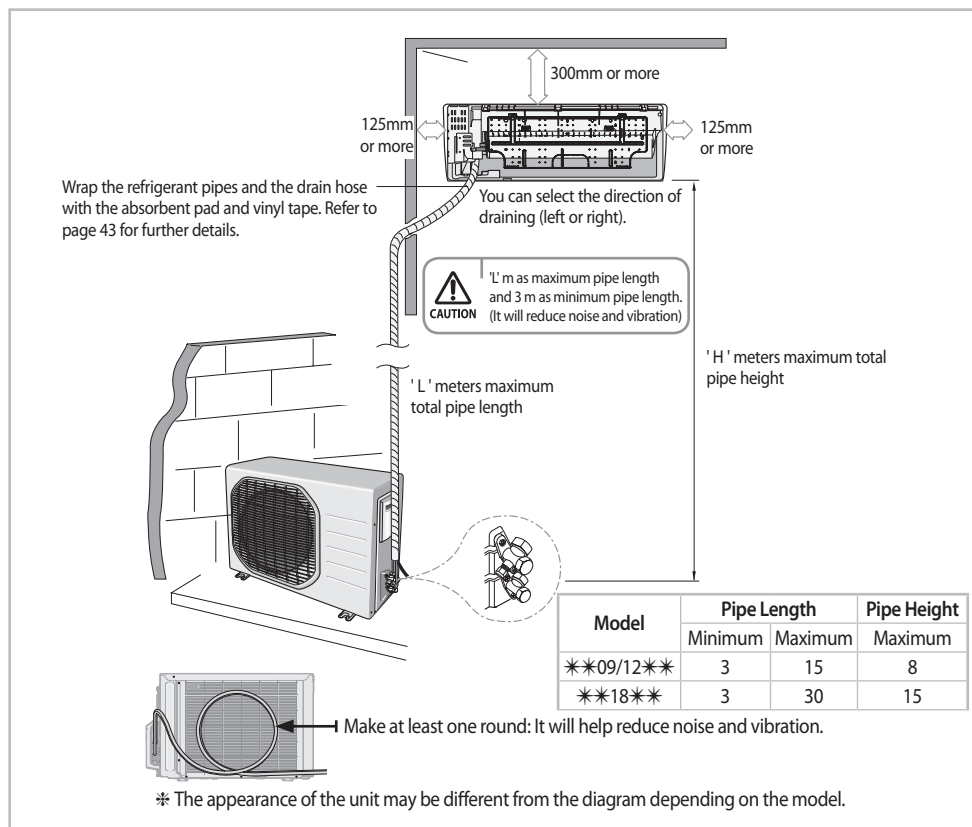



## Space Requirements for Outdoor Unit

### When installing 1 outdoor unit

#### ◆ Figure Description

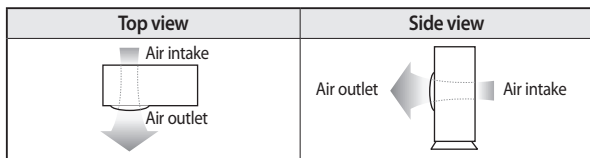

◆ Air flow direction.

#### ◆ When the air outlet is opposite the wall

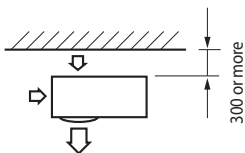

#### ◆ When the air outlet is towards the wall

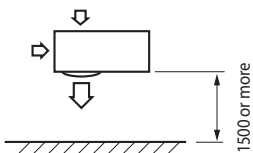

#### ◆ When 3 sides of the outdoor unit are blocked by the wall

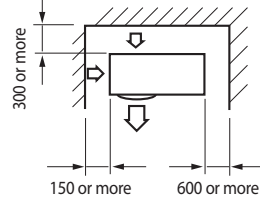

#### ◆ The upper part of the outdoor unit and the air outlet is towards the wall

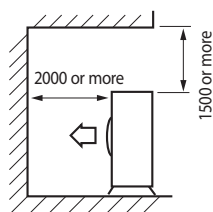

#### ◆ The upper part of the outdoor unit and the air outlet is opposite the wall

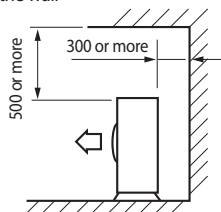

#### ◆ When the walls are blocking front and the rear side of the outdoor unit

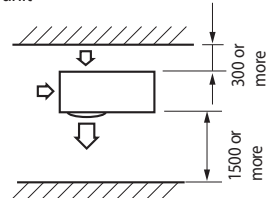

### When installing more than 1 outdoor unit

(Unit : mm)

#### ◆ When the air outlet is towards the wall

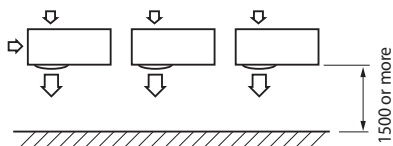

#### ◆ When 3 sides of the outdoor unit are blocked by the wall

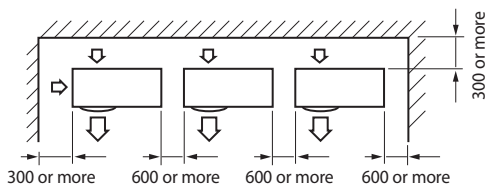

# Choosing the installation location

(Unit : mm)

- ◆ When the walls are blocking front and the rear side of the outdoor units

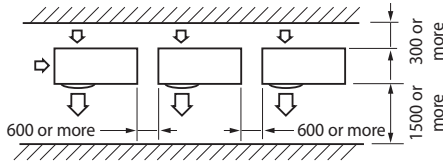

- ◆ When the upper part of the outdoor unit and the air outlet is opposite the wall

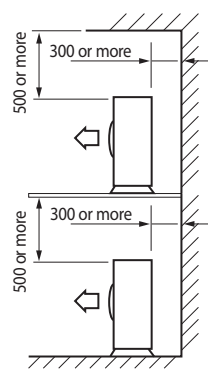

- ◆ When front and rear side of the outdoor unit is towards the wall

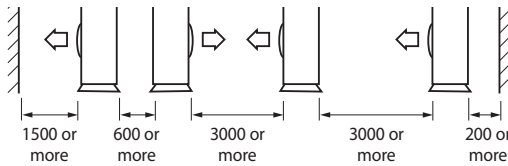

- If installation is done in inappropriate space, unit may generate sound and cause bad effect on the product.
- Installation must be done in level and in a place where vibration will not cause any effect.







## Accessories

The following accessories are supplied with the air conditioner:





- The number of each accessory is indicated in parentheses.

### Accessories in the indoor unit case

|  |  |  |   |  |
|--|--|--|---|--|
| Installation Plate (1)<br>    | Remote controller (1)<br>     | Batteries for Remote controller (2)<br> | User's & Installation Manual (1)<br> | Remote Control Holder (1)<br> |
| M4 x 25 Tapped Screws (6)<br> | M4 x 12 Tapped Screws (2)<br> |  |   |  |

### Accessories in the outdoor unit case

|   |   |
|---|---|
| Drain Plug (1)<br> | Rubber Leg (4)<br> |
|---|---|



- The flare nuts are attached to the end of each pipe of an evaporator or a service port. Use the nuts when connecting the pipes.
- The drain plug and rubber leg are only included when the air conditioner is supplied without the assembly pipe as seen in the picture below.

## Tools required for installation

### General Tools

- Vacuum Pump (Backward flowing prevention)
- Torque Wrench
- Screw Driver
- Pipe Cutter
- Reamer
- Spanner
- Drill
- Manifold Gauge
- Pipe Bender
- L Wrench
- Stud Finder
- Spirit Level
- Measuring Tape

### Tools for test operations

- Thermometer
- Resistance Meter
- Electroscope

## Fixing the installation plate

You can select the direction of the drain hose depending on where you want to install the indoor unit. Therefore before fixing the installation plate to a wall or a window frame, you must determine the position of the 65mm hole through which the cable, pipe and hose pass to connect the indoor unit to the outdoor unit.

When facing the wall, the pipe and cable can be connected from the:

- Right (A)
- Left (B)
- Underside\_right (C)
- Rear\_right or left (D)

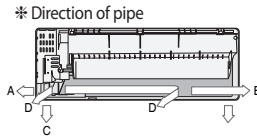

- You can install the refrigerant pipe in the left/right/bottom, or the rear side of the indoor unit.
- If changing the pipe direction from left to right, do not drastically bent it but slowly turn it in the opposite direction as shown. Otherwise, the pipe may be damaged in the process.

1. Determine the position of the pipe and drain hose hole as seen in the picture and drill the hole with an inner diameter of 65mm so that it slants slightly downwards.

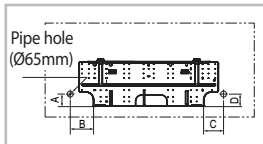

(Unit : mm)

| Model        | A  | B  | C  | D  |
|--------------|----|----|----|----|
| **09/12/18** | 47 | 74 | 74 | 47 |



- Make sure to drill only one hole after choosing the direction of the pipe.

2. Fix the indoor unit.

#### If you fix the indoor unit on a wall

- (1) Fix the installation plate to the wall giving attention to the weight of the indoor unit.



- If you mount the plate to a concrete wall using plastic anchors, make sure that gaps between the wall and the plate, created by projected anchor, is less than 20mm.

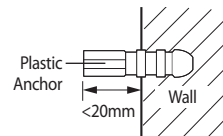

#### If you fix the indoor unit on a window frame

- (1) Determine the positions of the wooden uprights to be attached to the window frame.
- (2) Attach the wooden uprights to the window frame giving attention to the weight of the indoor unit.
- (3) Attach the installation plate to the wooden upright using tapping screws.

#### If you fix the indoor unit on a gypsum board

- (1) Use stud finder to find out locations of the studs.
- (2) Fix the plate hanger on two studs.



- Search for other spots if there are less than two studs, or the distance between the studs are different from the plate hanger.
- Fix the installation plate without inclining to one side.



- Make sure that a wall can withstand the weight of the product. If you install the product in a place where it is not strong enough to withstand the product weight, the unit could fall and cause injury.

# Connecting the assembly cable

## Cable specification

| Model        | Power cable                                    | Interconnection cable   | Type GL  |
|--------------|--|---|--|
| **09/12/18** | 3G, 2.5mm <sup>2</sup><br>H07RN-F(60245 IEC66) | 3G x 1.0mm <sup>2</sup> , H07RN-F (60245 IEC66)   | 10A(**09/12**)<br>15A (**18**)   |
|              | DRED Connected Wire                            | 2 x 0.75mm <sup>2</sup> , H05RN-F(60245 IEC57)<br>4 x 0.75mm <sup>2</sup> , H05RN-F (60245 IEC57)<br>(Only for reference) | -  |



- Connect the power cable to the auxiliary circuit breaker. If every pole fails to connect to the power supply, it must be incorporated in a wire with a contact opening of  $\geq 3\text{mm}$ .
- Use shield cable (Category 5; less than 50pF/m) for noisy environmental site.

## Connecting the cable

### Electrical work

- (1) For electrical and earth works, comply with the 'technical standards of electrical installations' and the 'wiring regulations' of the Local wiring regulations.
- (2) Tighten the terminal block screw to under 1.2 N.m (12 kgf.cm).
- (3) Precautions when connecting terminal blocks of the indoor unit

- ▶ Before connecting, make sure the connecting part of the terminal socket is facing upwards.

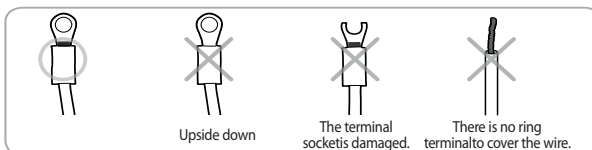

- ▶ There must be no space between the terminal and the screw when connected.  
- Any remaining space may become a fire hazard due to overheating of the electrical contact.

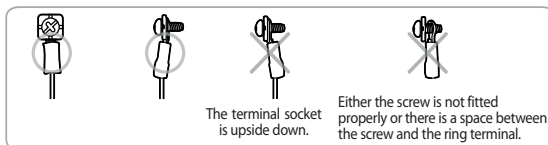

- For the terminal block wiring, use a wire with a ring terminal socket only. Regular wires without a ring terminal socket may become a fire hazard due to overheating of the electrical contact during a wiring work.

※ When you install the unit, make first refrigerant connections and then electrical connections.

Connect the air conditioner to grounding system before performing the electrical connection.

If unit is uninstalled, first disconnect electrical cables, then refrigerant connections.

If the outdoor unit is more than 7.5 meters away from the indoor unit, you must extend the cable. The maximum length of the cable is 15(\*\*09/12\*\*)/ 30(\*\*18\*\*)

### 1. Extend the assembly cable if necessary.



- Do not connect two or more different cables to extend the length. It may cause fire.



2. Open the front grille.
3. Remove the screw securing the connector cover.
4. Pass the assembly cable through the rear of the indoor unit and connect the assembly cable to terminals. (Refer to the picture below)



- Each wire is labeled with the corresponding terminal number.

5. Pass the other end of the cable through the 65mm hole in the wall.
6. Close the connector cover by tightening the screw carefully.
7. Close the front grille.
8. Remove the terminal board cover on the side of the outdoor unit.
9. Connect the cables to the terminals as seen in the picture.



- Each wire is labeled with the corresponding terminal number.
- DRED(Demand Response Enabling Device) may be supplied by the power supply utility.

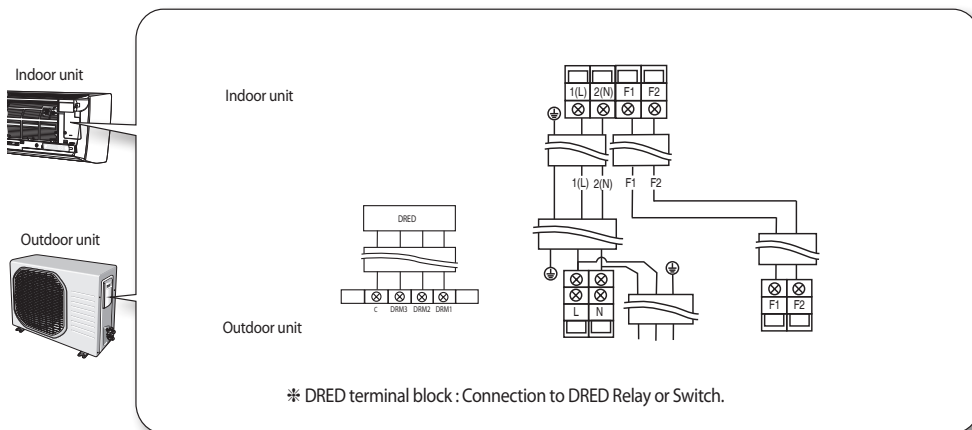

- Also circular terminal must be matched with screw size in terminal block.
- After connecting the cables, make sure terminal numbers on the indoor/outdoor unit matches.
- Please ensure that Power & Communication cables are separated, they must not be in the same cable.
- Do not connect 240 V direct to DRED's or F1/F2 terminal blocks.

10. Connect the grounding conductor to the grounding terminals.
11. Close the terminal board cover by tightening the screw carefully.



- In Russia and Europe, consult with the supply authority to determine the supply system impedance before installation.



- Connect the wires firmly so that wires can not be pulled out easily. (If they are loose, it could cause burn-out of the wires.)
- Connect the wires according to color codes, referring to the wiring diagram.
- The power cable and the interconnection cable should be selected according to the specification in page 32.

# Connecting the assembly cable

## DRED wiring diagram

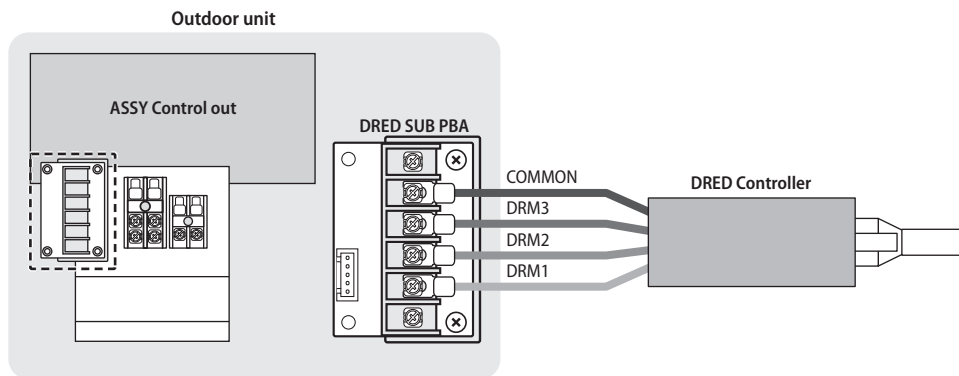

## Installing and connecting the assembly pipe of the indoor unit

Connect indoor and outdoor units with field-supplied copper pipes by means of flare connections. Use insulated seamless refrigeration grade pipe only, (Cu DHP type according to ISO1337), degreased and deoxidized, suitable for operating pressures of at least 4200 kPa and for burst pressure of at least 20700 kPa. Under no circumstances must sanitary type copper pipe be used.

There are 2 refrigerant pipes of different diameters:

- The smaller one is for the liquid refrigerant
- The larger one is for the gas refrigerant

A short pipe is already fitted to the air conditioner. You may need to extend the pipe using the assembly pipe (optional).

The connection procedure for the refrigerant pipe varies according to the exit position of the pipe when facing the wall:

- Right(A)
- Left(B)
- Underside(C)
- Rear

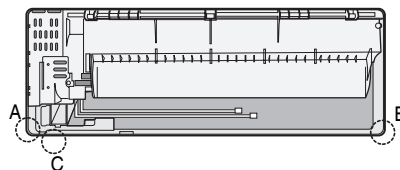

1. Cut out the appropriate knock-out piece (A, B, C) on the rear of the indoor unit unless you connect the pipe directly from the rear.
2. Smooth the cut edges.
3. Remove the protection caps of the pipes and connect the assembly pipe to each pipe. Tighten the nuts first with your hands, and then with a torque wrench, applying the following torque:

| Outer Diameter | Torque |         |
|----------------|--------|---------|
|                | N·m    | kgf·cm  |
| ø6.35 mm       | 14~18  | 140~180 |
| ø9.52 mm       | 34~42  | 350~430 |
| ø12.70 mm      | 49~61  | 500~620 |
| ø15.88 mm      | 68~82  | 690~830 |



• If you want to shorten or extend the pipes, refer to page 35~36.

4. Cut off the remaining foam insulation.
5. If necessary, bend the pipe to fit along the bottom of the indoor unit.  
Then pull it out through the appropriate hole.
  - ▶ The pipe should not project from the rear of the indoor unit.
  - ▶ The bending radius should be 100 mm or more.
6. Pass the pipe through the hole in the wall.
7. For further details on how to connect to the outdoor unit and evacuate the air, refer to page 39~41.



• The pipe will be insulated and fixed permanently into position after finishing the installation and the gas leak test; refer to page 43 for further details.



• Tighten the flare nut with torque wrench according to specified method.  
If the flare nut is over-tightened, the flare may break and cause refrigerant gas leakage.

• **DO NOT WALL UP THE PIPE CONNECTION !**  
All refrigerant pipe connection must be easy accessible and serviceable.

## Evacuating the indoor unit

The indoor unit is supplied with inert gas (nitrogen).

Before installing the unit, check if nitrogen gas flow out of indoor unit.

If this one isn't true, DO NOT INSTALL THE UNIT since leakage could be inside the indoor unit.

### 1. Unscrew the caps at the end of each pipe.

- ▶ All inert gas exhausts from the indoor unit.



• To prevent dirt or foreign substances from getting into the pipes during installation, do NOT remove the caps completely until you are ready to connect the pipes.



• The remaining air in the Refrigeration cycle, which contains moisture, may cause malfunction on the compressor.

• Always contact the service center or a professional installation agency for product installation.

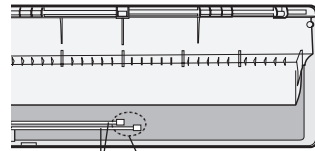

## Cutting or extending the pipe

The length of the pipe can be:

- Extended up to: see table page 28
- Shorten up to: see page 28



If you need a pipe longer than 7.5 meters:

- You must add refrigerant to the pipes; otherwise, the indoor unit may freeze.

# Cutting or extending the pipe

1. Make sure that you have all the required tools (pipe cutter, reamer, flaring tool and pipe holder).
2. If you want to shorten the pipe, cut it using a pipe cutter, ensuring that the cut edge remains at 90° with the side of the pipe (see below examples of correct and incorrect cut edges).

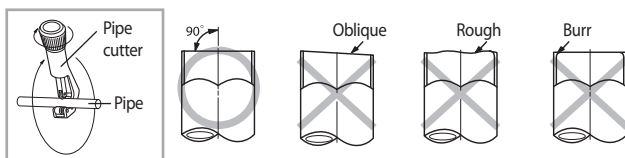

3. To prevent a gas leak, remove all burrs at the cut edge of the pipe using a reamer.



• Face the pipe down while removing the burrs to make sure that burrs do not get in to the pipe.

4. Put a flare nut slightly into the pipe and modify the flare.

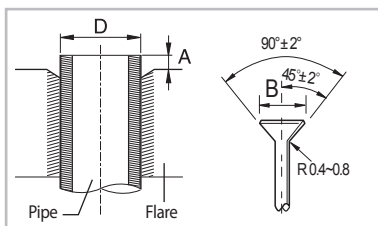

| Outer Diameter (D) | Depth (A) | Flaring Size (B) |
|--------------------|-----------|------------------|
| ø6.35 mm           | 1.3 mm    | 8.7 - 9.1 mm     |
| ø9.52 mm           | 1.8 mm    | 12.8 - 13.2 mm   |
| ø12.70 mm          | 2.0 mm    | 16.2 - 16.6 mm   |
| ø22.23 mm          | 2.2 mm    | 19.3 - 19.7 mm   |

5. Check if you flared the pipe correctly (see examples of incorrectly flared pipes below).



6. Align the pipes to connect them easily. Tighten the flare nuts first with your hands, and then with a torque wrench, applying the following torque:

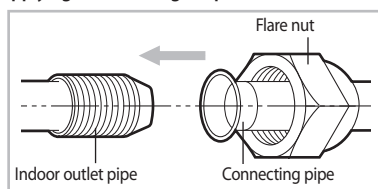

| Outer Diameter | Torque |         |
|----------------|--------|---------|
|                | N·m    | kgf·cm  |
| ø6.35 mm       | 14~18  | 140~180 |
| ø9.52 mm       | 34~42  | 350~430 |
| ø12.70 mm      | 49~61  | 500~620 |
| ø15.88 mm      | 68~82  | 690~830 |



• Excessive torque can be cause of gas leakage. If extending pipe by welding/brazing please ensure nitrogen is used during welding/brazing process. The joint must be accessible and serviceable.

7. For further details on how to connect to the outdoor unit and evacuate the air, refer to page 39~41.



• Tighten the flare nut with torque wrench according to specified method. If the flare nut is over-tightened, the flare may break and cause refrigerant gas leakage.

# Installing and connecting the drain hose of the indoor unit

When installing the drain hose for the indoor unit, check if condensation draining is adequate.  
When passing the drain hose through the 65-mm hole drilled in the wall, check the followings:

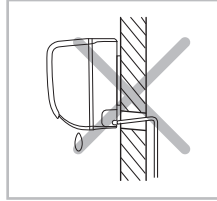
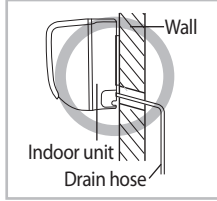

The drain hose must NOT slant upwards.

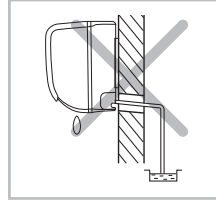

The end of the drain hose must NOT be placed under water.

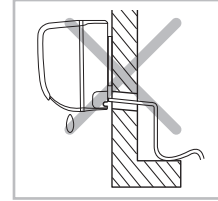

The drain hose must not be bent.

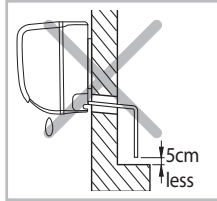

Keep a clearance of at least 5cm between the end of the drain hose and the ground.

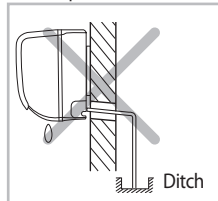

Do not place the end of the drain hose in a hollow.

After completing the installation of the drain hose, pour water into the drain pan to check whether the hose is well drained.

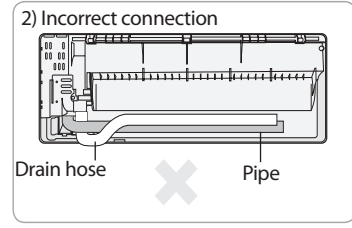
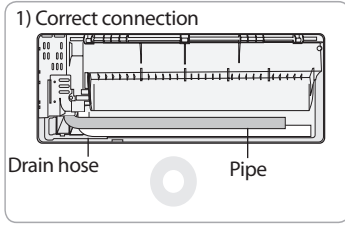

**CAUTION** • Don't tie drain hose to the assembly pipe which may lead to water leakage.

## Drain hose installation

1. If necessary, connect the 2-meter extension drain hose to the drain hose.
2. If you use the extension drain hose, insulate the inside of the extension drain hose with a shield.
3. Fit the drain hose into 1 of 2 drain hose holes, then fix the end of the drain hose tightly with a clamp.

**NOTE** • If you do not use the other drain hose hole, block it with a rubber stopper.

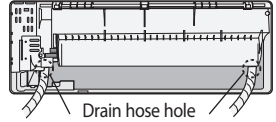

4. When extending the Drain Hose, hold the end of Drain Hose and Extended Hose, rotate and insert the drain hose into Extended hose for 40~45 mm. Make sure the two hoses are firmly connected, there is no water leakage.
5. Connect the Drain Hose after using Foam Insulation to wrap the Extended Hose. Then, Use vinyl tape to wrap the each side of connection by 20mm.

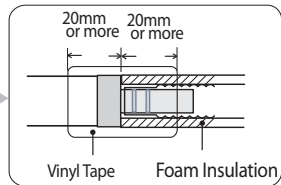
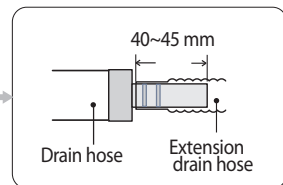
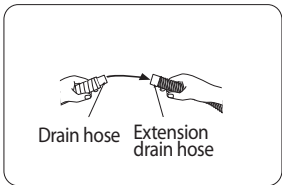

## Installing and connecting the drain hose of the indoor unit

6. Pass the drain hose under the refrigerant pipe, keeping the drain hose tight.
7. Pass the drain hose through the hole in the wall. Check if it slants downwards as seen in the picture.
8. Using natural drainage method, check the drainage is normal.

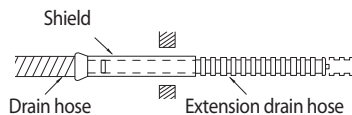

- The hose will be fixed permanently into position after finishing the installation and the gas leak test; refer to page 43 for further details.



- Make sure the installed direction of the drain hose is correct. Inadequate installation may cause condensate water leakage.
- If the drain hose is routed inside the room, insulate the hose so that dripping condensation does not damage the furniture or floors.
- **DO NOT WALL UP THE DRAIN HOSE CONNECTION!**  
Drain hose connection must be easy accessible and serviceable.

## Changing direction of the drain hose

Change the direction only when it is necessary.

1. Detach the rubber cap with the plier.
2. Detach the drain hose by pulling it and turning to the left.
3. Insert the drain hose by fixing it with the screw into the groove of the drain hose and the outlet of the drain pan.
4. Attach the rubber cap with a screwdriver by turning it to the right until it fixes to the end of the groove.
5. Check for leakage on both side of the drain outlet.

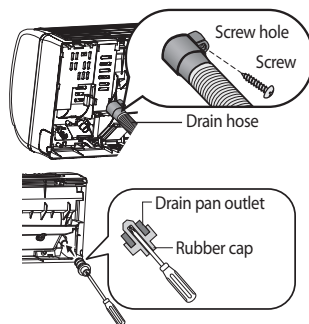

Pour the water in direction of arrow. ※ Direction of the drained water

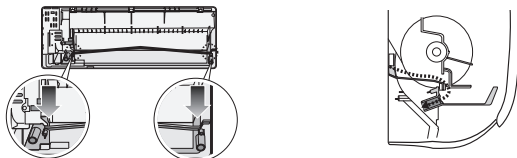

- Make sure the indoor unit is in upright position when you pour water to check for leakage. Make sure that the water does not overflow onto the electrical part.

## Installing and connecting the drain hose of the outdoor unit

While heating, ice may accumulate. During the process of defrosting, check if condensation draining is adequate. For adequate draining, do the following.

1. Insert the drain plug into the drain hole on the underside of the outdoor unit.



- To avoid drain plug from contacting the ground, secure gap between the ground and the bottom surface of the outdoor unit.

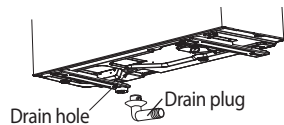

2. Connect a drain hose to the drain plug.

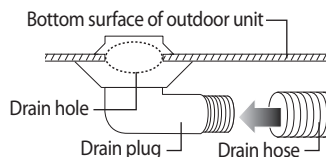

3. Ensure that condensation draining is adequate.



- In areas with heavy snow fall, piled snow could block the air intake. To avoid this incident, install a frame that is higher than estimated snow fall. In addition, install a snow-proof hood to avoid snow from piling on the outdoor unit.

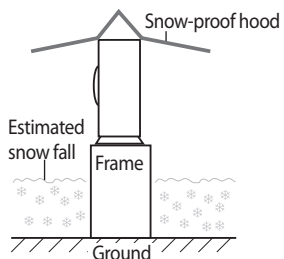

## Evacuating the connected pipes

The outdoor unit is loaded with sufficient R-410A refrigerant. Do not vent R-410A into atmosphere: it is a fluorinated greenhouse gas, covered by Kyoto Protocol, with a Global Warming Potential (GWP) = 1975.

You should evacuate the air in the indoor unit and in the pipe. If air remains in the refrigerant pipes, it affects the compressor. It may cause reduction of cooling capacity and malfunction. Use Vacuum Pump as seen in the picture.



- When installing, make sure there is no leakage. When recovering the refrigerant, ground the compressor first before removing the connection pipe. If the refrigerant pipe is not properly connected and the compressor works with the service valve open, the pipe inhales the air and it makes the pressure inside of the refrigerant cycle abnormally high. It may cause explosion and injury.

# Evacuating the connected pipes

1. Connect each assembly pipe to the appropriate valve on the outdoor unit and tighten the flare nut.
2. Tighten the flare nut first with your hands, and then with a torque wrench, applying the following torque.

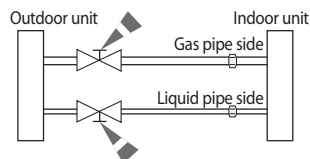

- Excessive torque can be cause of gas leakage.



- Make the electrical connection and leave the system into "stand by mode". Do not turn on the system!  
This is necessary for better vacuum operation (full OPEN position of Electronic Expansion Valve - EEV -).

| Outer Diameter | Torque |         |
|----------------|--------|---------|
|                | N·m    | kgf·cm  |
| ø6.35 mm       | 14~18  | 140~180 |
| ø9.52 mm       | 34~42  | 350~430 |
| ø12.70 mm      | 49~61  | 500~620 |
| ø15.88 mm      | 68~82  | 690~830 |

3. Connect the charging hose of the low-pressure side of manifold gauge to a gas service port as seen in the picture.
4. Open the valve of the low pressure side of manifold gauge counterclockwise.
5. Evacuate the air in the connected pipes using the vacuum pump for about 15 minutes.
  - ▶ Make sure that pressure gauge shows -0.1MPa(-76cmHg) after about 10 minutes.  
This procedure is very important to avoid a gas leak.
  - ▶ Close the valve of the low pressure side of manifold gauge clockwise.
  - ▶ Turn off the vacuum pump.
  - ▶ Check for 2 minutes if there is any pressure change.
  - ▶ Remove the hose of the low pressure side of manifold gauge.
6. Set a valve cork of liquid and gas service port to the open position.

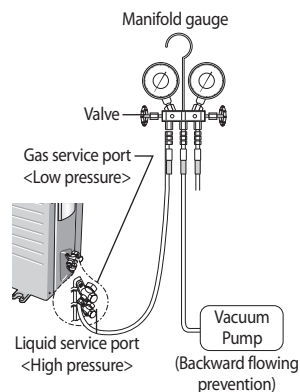

## Adding Refrigerant

Add refrigerant charge according to table below:

**If you use a pipe longer than 7.5m,**  
'A'g of refrigerant R-410A must be added for each extra meter.

**If you use a pipe shorter than 7.5m,**  
The evacuate time is normal.

Refer to the Service Manual for further details.

| Model     | A  |
|-----------|----|
| **09/12** | 15 |
| **18**    | 15 |



- The remaining air in the Refrigeration cycle, which contains moisture, may cause malfunction on the compressor.
- Always contact the service center or a professional installation agency for product installation.



## Important information regulation regarding the refrigerant used

This product contains fluorinated greenhouse gases covered by the Kyoto Protocol.  
Do not vent gases into the atmosphere.

| Refrigerant type | GWP value |
|------------------|-----------|
| R-410A           | 1975      |

\* GWP=Global Warming Potential

### 1. Please fill in with indelible ink,

- ▶ ① the factory refrigerant charge of the product,
- ▶ ② the additional refrigerant amount charged in the field and
- ▶ ①+② the total refrigerant charge. on the refrigerant charge label supplied with the product.



- a. Factory refrigerant charge of the product: see unit name plate
- b. Additional refrigerant amount charged in the field (Refer to the above information for the quantity of refrigerant replenishment.)
- c. Total refrigerant charge
- d. Refrigerant cylinder and manifold for charging

Contains fluorinated greenhouse gases covered by the Kyoto Protocol.

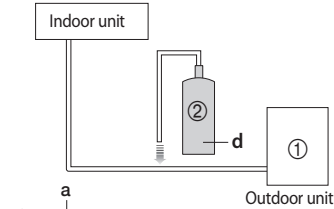

① = (  $\frac{\quad}{\quad}$  ) kg  
 ② = (  $\frac{\quad}{\quad}$  ) kg      ①+② = (  $\frac{\quad}{\quad}$  ) kg



- The filled-out label must be adhered in the proximity of the product charging port (e.g. onto the inside of the stop valve cover).

## Charging the refrigerant under conditions of liquid by using a liquid pipe

R-410A is a mixed type of refrigerant. It is necessary for recharging under conditions of liquid. When recharging refrigerant from the refrigerant cylinder to the equipment, follow the instructions below.

1. Before recharging, check whether the cylinder has a siphon or not.  
There are two ways to recharge the refrigerant.

### Cylinder with siphon

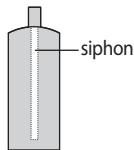

- ▶ Charge the refrigerant standing the cylinder upright.

### Cylinder without siphon



- ▶ Charge the refrigerant turning the cylinder upside down.



- If R-410A refrigerant is charged with gas, the composition of the charged refrigerant changes and the characteristics of the equipment vary.
- During the measuring operation of refrigerant quantity added use electronic scales.  
If cylinder doesn't have syphon, upset it.

# Performing the gas leak tests

Make sure to check for gas leaks before completing the installation process (connecting the assembly pipe and hose between indoor unit and outdoor unit, insulating the cables, hose and pipe, and fixing the indoor unit to the installation plate).

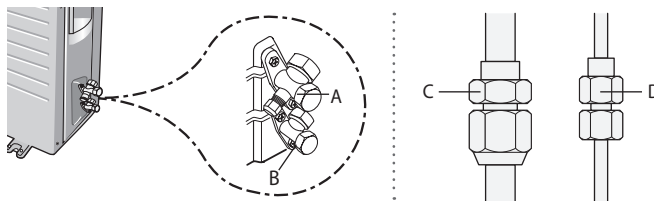

Test part for outdoor unit

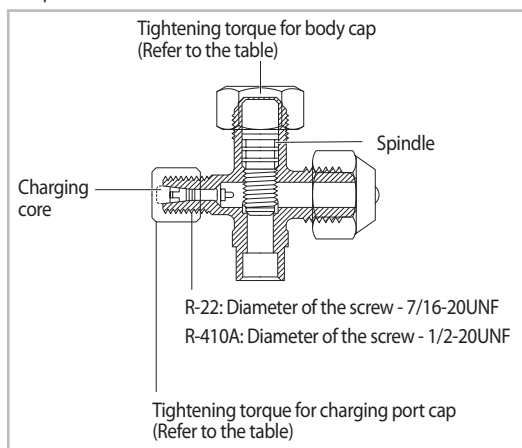

Test part for indoor unit

- ▶ Before inspecting the leakage, use a torque wrench to close the cap for the service valve. (Comply with a tightening torque for each size of the diameter, and tighten the cap firmly to prevent any leakage.)
- ▶ To check for any possible leakage, insert inert gas into the pipes connected to indoor/outdoor units and check the connection part of the indoor/outdoor units with soap lather or liquid for leakage test.

| Outer Diameter (mm) | Tightening torque |                         |
|---------------------|-------------------|-------------------------|
|                     | Body cap (N·m)    | Charging port cap (N·m) |
| ø 6.35              | 20 ~ 25           | 10 ~ 12                 |
| ø 9.52              | 20 ~ 25           |                         |
| ø 12.70             | 25 ~ 30           |                         |
| ø 15.88             | 30 ~ 35           |                         |
| ø 19.05             | 35 ~ 40           |                         |

( 1 N·m = 10 kgf·cm )

**To check for gas leaks on the outdoor unit,**  
Check the valve A and B using a leak detector.

**To check for gas leaks on the indoor unit,**  
Check the flare nut C and D using a leak detector.

## Leak test with nitrogen (before opening valves)

In order to detect basic refrigerant leaks, before recreating the vacuum and recirculating the R-410A, it's responsible of installer to pressurize the whole system with nitrogen (using a cylinder with pressure reducer) at a pressure above 40 bar (gauge).

## Leak test with R-410A (after opening valves)

Before opening valves, discharge all the nitrogen from the system and create vacuum according to page 39~41. After opening valves, check leaks using a leak detector for refrigerant.

## Pump down (before disconnecting the refrigerant connections for unit repair, removal or disposal)

Pump-down is an operation intended to collect all the system refrigerant in the outdoor unit. This operation must be carried out before disconnecting the refrigerant tubing in order to avoid refrigerant loss to the atmosphere.

- ▶ Shut off the liquid valve with the Allen wrench.
- ▶ Turn the system on in cooling with fan operating at high velocity.  
(Compressor will immediately start, provided 3 minutes have elapsed since the last stop).
- ▶ After 2 minutes of operation, shut the suction valve with the same wrench.
- ▶ Turn the system off and switch mains supply off.
- ▶ Disconnect tubing. After disconnection, protect valves and tubing ends from dust.
- ▶ Compressor damage may occur if run at a negative suction pressure.

## Fixing the indoor unit in place

Perform the following work on the area where gas leak test was done priorly.

After checking for gas leaks in the system, insulate the pipe, hose and cables. Then place the indoor unit on the installation plate.

1. To minimise condensation problems, wrap foam insulation (as shown in the figure) on a part without insulation on the end of the pipes.
2. Wind the pipe, assembly cable and drain hose with vinyl tape.
3. Place the bundle (the pipe, assembly cable and drain hose) in the lower part of the indoor unit carefully so it does not project from the rear of the indoor unit.
4. Hook the indoor unit to the installation plate and move the unit to the right and left until it is securely in place.



• Make sure pipe does not move when you install the indoor unit on an installation plate.

5. Wrap the rest of the pipe with vinyl tape.
6. Attach the pipe to the wall using clamps (optional).

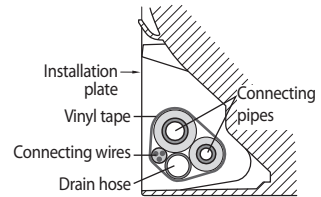
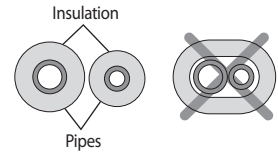

## Fixing the outdoor unit in place

Install the outdoor unit in level on a stable base to help avoid the generation of noise and vibration, especially when installing the unit close to a neighbor.

If you install the outdoor unit in a place exposed to strong winds or at a height, fix it to an appropriate support (wall or ground).

1. Place the outdoor unit as indicated on the top of the unit to let the discharged air out properly.
2. Fix the outdoor unit in level to an appropriate support using anchor bolts.
3. If the outdoor unit is exposed to strong winds, install shield plates around the outdoor unit so that the fan can operate correctly.

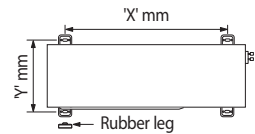

| Model     | X   | Y   |
|-----------|-----|-----|
| **09/12** | 543 | 319 |
| **18**    | 660 | 340 |



• Secure the rubber leg to help prevent the generation of noise and vibration.

### Outdoor unit installed on the wall by rack

- Ensure the wall will be able to suspend the weight of rack and outdoor unit;
- Install the rack close to the column as much as possible;
- Install proper grommet in order to help reduce noise and residual vibration transferred by outdoor unit towards wall.

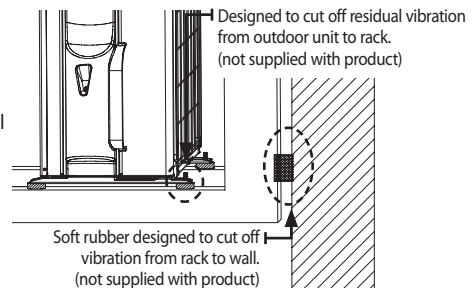

# Final Check and Trial Operation

To complete the installation, perform the following checks and tests to ensure that the air conditioner operates correctly.

## Check the followings:

- Strength of the installation site
- Tightness of pipe connection to detect gas leak
- Electric wiring connection
- Heat-resistant insulation of the pipe
- Drainage
- Grounding conductor connection
- Correct operation (follow the steps below)

### 1. Press the **Power** (⏻) button and check the following:

- ▶ The indicator on the indoor unit lights up.
- ▶ The airflow blade opens and the fan gears up for operation.

### 2. Press the **Mode** button to select Cool or Heat mode.

- ▶ In Cool mode, use **Temp hr.** + or – button and set the temperature at 16°C.
- ▶ In Heat mode, use **Temp hr.** + or – button and set the temperature at 30°C.



- Approximately 3~5 minutes later, outdoor unit will start to operate and the Cool or Warm air will blow out.
- After 12 minutes of stationary condition check the indoor unit air treatment.

Cooling mode (indoor unit check) → Inlet air temp. - Outlet air temp:  
From 10°C to 12°C (indicative delta T)

Heating mode (indoor unit check) → Outlet air temp. - Inlet air temp:  
From 11°C to 14°C (indicative delta T)

In heating mode, the indoor fan motor can remain off to avoid cold air blown into conditioned space.

### 3. Press the **Air swing** (≡) button and check the following:

- ▶ The airflow blades work properly.

### 4. Press the **Power** (⏻) button to stop the operation.



- When you complete the installation successfully, hand over this manual to the user for storage in a handy and safe place.

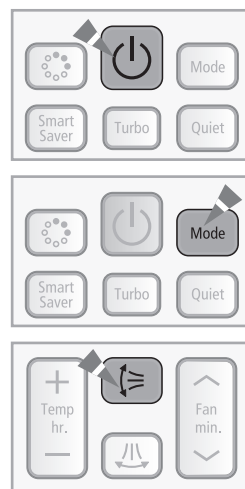





## Pump down procedure (when removing the product)

1. Press the **Power** (⏻) button on the indoor unit for 5 seconds. Beep will sound immediately to let you know that the product is ready for pump down procedure. Please let the compressor run for more than 5 minutes.
2. Release the valve caps on High and Low pressure side.
3. Use L wrench to close the valve on the high pressure side.
4. After approximately 2 minutes, close the valve on the low pressure side.
5. Stop operation of the air conditioner by pressing the power button on the indoor unit or remote controller.
6. Disconnect the pipes.

# How to connect your extended power cables

Items to prepare  
(compressor and insulation tape should be prepared by an installation technician.)

| Tools | Crimping plier  | Connection sleeve (mm)  | Insulation tape   | Contraction tube (mm)   |
|-------|---|---|---|---|
| Spec  | MH-14   | 20xØ7.0(HxOD)   | Width 18mm  | 50xØ8.0(LxOD)   |
| Shape |  |  |  |  |

- As shown in the figure, peel off the shields from the rubber/wire of the power cable.

- Peel off 20 mm of the wire shields of the tube installed already.



• After peeling off the tube wire, you must insert a contraction tube.

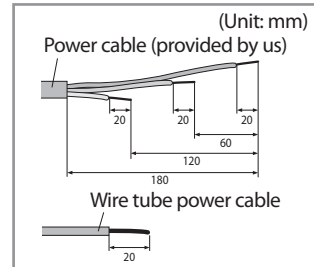

- Insert both sides of core wire of the power cable into the connection sleeve.

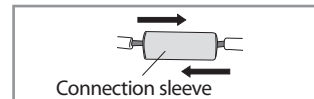

- Using a compressor, compress the two points and flip it over and compress another two points in the same location.

- The compression dimension should be 8.0.
- After compressing it, pull both sides of the wire to make sure it is firmly pressed.

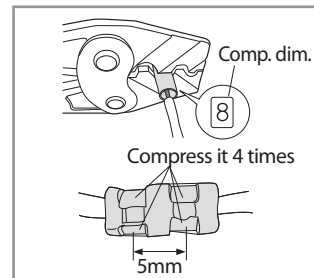

- Wrap it with the insulation tape twice and position your contraction tube in the middle of the insulation tape.

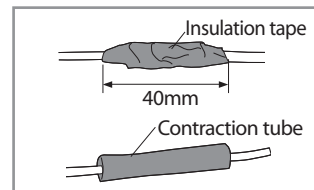

- Apply heat to the contraction tube to contract it.

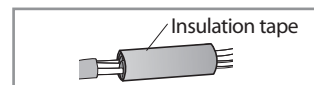

- After tube contraction work is completed, wrap it with the insulation tape to finish.



• In case of extending the electric wire, please DO NOT use a round-shaped pressing socket.  
• Incomplete wire connections can cause electric shock or a fire.

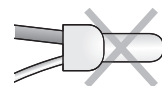







QUESTIONS OR COMMENTS?

| COUNTRY     | CALL         | OR VISIT US ONLINE AT  |
|-------------|--------------|--|
| AUSTRALIA   | 1300 362 603 | <a href="http://www.samsung.com/au/support">www.samsung.com/au/support</a> |
| NEW ZEALAND | 0800 726 786 | <a href="http://www.samsung.com/nz/support">www.samsung.com/nz/support</a> |



DB98-34690A-06