

CAMBRO®



SCAN TO WIN
Enter to Win Cambro's
Monthly Product Giveaway!
Scan this QR Code or visit
<http://www.cambro.com/win>

2012-2013

product catalog
www.cambro.com

Cambro® Catalog Table of Contents



7-48



49-64



76-92



107-136

TRAYS

Tray Product Guide	9-13
Personalization	14-15
Versa Trays	16-20
Versa Lite Trays	21-24
Camtray® Trays	25-30
Color Chart	28-29
Dietary Trays	31
Camlite® Trays	31
Camtread® Trays	32
Wood Trays	33-34
Corfu Trays	35
Capri Trays	36-37
Mykonos Trays	38
Madeira Trays	39
Fast Food Trays	40
Polytread® Trays	41
Camwear® Polycarbonate Trays	41
School Compartment Trays	42
Camwear Polycarbonate Compartment Trays	43-44
Meal Delivery Trays	45-46
Market Trays	47
V-Series Tray	47
Insulated Trays	48

TABLE SERVICE

Dinnerware	50-51
Versa Camcover®	52
Camcover Plate Covers	53
Personalization	54
Pitchers	55
Aliso™ Barware	56
Goblets	56
Dessert Glass	56
Tumblers	57-62
CamLid®	58
Camliters®/Decanters	62
21 Liter Beverage Dispenser	63
Pail with Bail	63
Swirl Bowls®	63
Punch Bowls	64
Wine Buckets	64
Bud Vase	64

CAMSHELVING®

Camshelving®	78-92
Assembly	79
Components	81
Space Utilization	82
Footprint Dimensions	83
Stationary Post Kits	84
Vented Shelf Kits	84
Solid Shelf Kits	84
Vented Starter Units	85-87
Dunnage Stand	87
Corner Connectors	87
Mobile Post Kits	88
Casters	88
Fence System	88
Vented Mobile Starter Units	89
High Density Storage System	90-91
Security Cage	92
Divider Bars	92
Tray Slider Rack	92

FOOD STORAGE AND PREPARATION

Storage Container Solutions	108
Material Summary	108
Square Food Containers	110-113
Round Storage Containers	114-117
Food Storage Boxes, Colanders & Lids	118-121
Camwear Polycarbonate Food Pan, Colanders & Lids	122-125
H-Pans™, Colanders & Lids	126-129
Translucent Food Pans & Lids	130-131
ColdFest® Pans, Cocks, Covers & Pumps	132
StoreSafe® Labels	133
Pizza Dough Boxes	134
Ingredient Bins	135
Camcrisper®	135
Scoops	136
Measuring Cups	136



65-75



93-106

FOOD PRESENTATION

Deli Crocks & Platter	66
ShowFest® Display Bowls & Trays	67
Salad Bowls	68-70
Display Covers & Trays	71
Crocks	72
Ladles	72
Serving Spoons	73
High Heat Serving Spoons	73
Tongs	74
Shakers/Dredges	75
Condiment Jars	75

ELEMENTS SERIES

Camshelving Elements Series	93-104
Weight Capacity	94
Space Utilization	95
Configuration Details	96
Consulting Service	96
Post Kits	97
Accessories	97
Shelf Kits	98-99
Starter Units	100
Add-on Units	101
Mobile Post Kits	102
Mobile Starter Units	103-104
Divider Bars	104
Wall Shelf Kits	105
S-Series Dunnage Racks	106
Camlink®	106



137-158

MOBILE VENDING

Versa Food Service System	138-141
Food Bars, Accessories & Sizes	142-143
CamKiosk® System	144-145
CamKiosk Personalization	146
CamKiosk Cart	146
CamKiosk Work Station	147
Equipment Stands	147
CamKiosk Hand Sink Cart	147
Vending Carts	148-149
Booster Seats	150
Organizers	150
Portable Cambars®	152-157
Ice Caddies	158



159-184

FOOD HOLDING & TRANSPORTATION

CamServers®	160
Handwash Accessory	160
Ultra Camtainers®	162-163
Camtainers	163
Risers	163
Condiment Holder	163
Easy Serve Dispenser	163
Camcarriers®	164-165,168,183
S-Series Ultra Pan Carriers	165
Ultra Pan Carriers®	165,168
Camchiller®	166-167
ThermoBarrier®	166-167
Camwarmer®	166-167
Ultra Camcarts®	172-173
UPCH400/UPCH800/UPCH1600	
H-Series	175-177
Transporter Capacity Guide	178
Combo Carts™	179
Insulated Bakery Container	179
Camtherm Cart®	180-181
Camcarts	182-183
Beverage Service Cart	184

www.cambro.com

Visit www.cambro.com for a wide variety of information about our products including new product updates, an interactive Camrack Glass to Rack Guide, consultant cut sheets and CAD drawings, care and maintenance product guides and more.



185-198

HEALTHCARE

Why Cambro® Healthcare	186
Insulated Meal Delivery System	187
Reusable CamLids®	188
Camrack® Wash and Store Rack	188
Dome Drying and Storage Cart	188
Disposable CamLids®	189
Versa Trays	190-193
Versa Lite Trays	192
Tablotherm	194-195
Meal Delivery Carts	196-198

GENERAL INFORMATION

Icon Directory	6
Alpha Numeric Listing	228-238
Roto Color Chart	239



199-227

WAREWASHING, HANDLING & STORAGE

Cambox® Bussing Boxes	200
KD Service Cart	201
KD Utility Cart	201
Service Carts	202
Camdollies®	203-205
Utility Trucks	205
Tray & Dish Cart	206
Tray & Silver Cart	206
Dish Caddies	207-209
Camracks	211-227
Full Size Racks	212-214
Half Size Racks	215
Cup Racks	216
Glass & Cup Keeper	216
Base Racks	217
Peg Rack	218
5 x 9 Peg Rack	218
Open End Tray Rack	218
Flatware Racks	218
Camrack PlateSafe™	219
Camdolly & Camrack Cover	220
Camrack IceExpress Glass Filler	220
Selecting the Right Camrack	220
Component System	221-223
Personalization & Color Coding	224-225
Sizing & Reference Guide	226-227

PERSONALIZATION

Trays	14,15
Table Service	54
CamKiosk	146
Camcruisers	149
Camracks	224,225

the **cambro**[®] story

When William and Argyle Campbell first opened the doors at Cambro Manufacturing in 1951 their goal was to make a hospital meal tray of the highest quality possible. Named the Camtray[®], it demonstrated that they were as committed to excellence in the food service industry as they were to the quality of their own products. As 2011 marks the company's 60th year of leadership in quality, innovation and customer service, today Cambro serves the world with the industry's most complete selection of products for widely diverse segments of the food service business.

Since 1951, the company has experienced many changes including a greatly expanded product line, new methods of manufacturing and distribution, and an increased emphasis on issues like environmental responsibility. From a single factory in California, Cambro has grown to become an international presence with production facilities and sales offices in the United States, Europe, the Middle East and Asia. But the original guiding vision of the Campbell brothers remains unchanged: to create and provide the most innovative, durable and highest quality products for the food service industry. Now led by William's son Argyle, Cambro is still dedicated to meeting our customers' needs, and equally committed to helping you serve, satisfy and delight your guests.

1951



1960's



1970's



1980's



At the heart of our business philosophy is our willingness to listen, so in a very real way we owe all our success to you, our customer. Our longevity in a very competitive field for 60 years certainly proves the value of that philosophy, and we are proud to have earned the loyalty of customers of all sizes and in all segments of the industry. From hotels to healthcare to caterers, from restaurant chains to educational facilities, we understand the food service business and we design and create our products with the end user foremost in mind. Our goal is to provide our customers the best possible value on products that are durable, save labor and increase food safety, so you can offer your guests a superior experience while enhancing profitability.

Cambro is uniquely committed to investing in the people and processes that make our products a reality. We're proud that children and grandchildren of some of our first employees are with us today, and of the dedication to quality and service of our entire family worldwide. We continually work on developing new ideas for specific industry segments, and invest in new tooling and leading-edge machinery to bring these products to market. We persistently strive to improve our manufacturing methods to be more efficient in terms of process and materials, to keep costs under control

while keeping our planet healthy. And we constantly seek to maintain quality and value despite rising costs of transport and raw materials, the need to reduce environmental impacts, and the demand of end users for total order accuracy and responsive service across a global market.

From once offering a single product, the Camtray, sixty years ago, today Cambro offers a wide range of trays, table service and display items, storage, shelving, merchandising and insulated transport products, as well as innovative warewashing systems and healthcare meal delivery solutions.

The future is certain to bring great changes to our industry. Yet one thing that will remain a constant is Cambro's tradition of continually developing new products that help food service operators save time and money, increase sales, reduce labor and improve service. In the years ahead, guided by the commitment of its founders to innovation, quality, and value, Cambro Manufacturing will still be the leader in serving the food service industry and you, our valued customer.

1990's



2000's



2010



2011



Cambro Warranty

Cambro Camtrays® and Camwear® Dinnerware have a five year guarantee against breakage. Camtherm® Bulk Food Holding Cabinets hold a one-year warranty. Polycarbonate food storage products are guaranteed for two years under normal usage. Camshelving® has a one-year warranty on workmanship and a lifetime limited warranty against rust and corrosion, excluding mobile posts.

For all other Cambro products, Cambro warrants to the original buyer a three-year pro-rated guarantee. If product proves defective during this time, Cambro grants a pro-rated credit of the original price toward replacement product. The warranty applies on all Cambro products only when used under normal foodservice industry conditions.

Specifications, features and equipment shown are based upon the latest information available. Cambro Manufacturing Company reserves the right to make changes at any time, without notice, to price, colors, specifications, accessories and materials. For additional information, please contact your authorized Cambro representative.

Note: Temperature ranges noted throughout this catalog are based on specific test criteria and provide a general guideline. Individual use may vary due to differences in loading temperatures or ambient temperature.

Product Accessories: Contents and accessories shown in photos are not included, except where noted.

ICON DIRECTORY

Throughout the Cambro catalog, find the following easy to identify icons to help explain Cambro product features or services.



Store and Transport Food Safely

Cambro is committed to providing food service operators with products to help meet HACCP guidelines.

- Cambro food storage products are designed to help keep food fresh and reduce cross contamination.
- Camshelving is easy to clean to provide a sanitary storage area.
- Cambro catering and merchandising equipment maintain food temperatures to safely hold and transport food.
- The closed wall design of the Camrack® Warewashing and Storage System allows glassware to be stored in an enclosed sanitary place.

Look for the Cambro StoreSafe mark throughout the Cambro catalog to identify Cambro storage and transportation products that help ensure safe food handling.



Many Cambro products may be recycled. For further information, please contact your Cambro representative.



Listed by the National Sanitation Foundation. NSF, an independent testing organization, lists products which meet their criteria for sanitation and cleanliness.



Not For Use In Heated Carts



Fit for Food Products



Dishwasher Safe



Pro-rated Warranty



Foam Insulation



Stackable

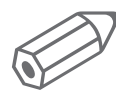

Personalization Available
Non-Food Contact Areas Only



One carton of product is within the weight and cube requirements to be shipped by parcel carrier.



New Product

TRAYS



Choose the Right Tray for Your Business

Cambro is the global leader in manufacturing trays for the food service industry, offering the largest selection of materials, sizes, colors, shapes and personalization processes. Cambro's breadth of assortment provides the clear choice for the right tray for every need and budget.

Consider the following to select the right tray for your operation:

Step 1: What Will the Tray Be Used For?

In order to choose the correct tray, first identify the correct application.

Service Tray

Used by employees to carry items to serve to guests:

Non-Slip Tray

Patron Tray

Used by customers to carry menu items:

Smooth Surface Tray

Step 2: Who Will Be Using the Tray?

To determine the appropriate tray material, it is critical to identify who will be using the tray.

Children

Students

Military

Office Employees

Wait Staff

Step 3: How Will the Tray Be Used and Washed?

Consider how the tray will be used, and whether it will endure mild or excessive use and abuse. Determine how often the trays will be washed per day.

Extensive:

Wash as often and as frequently as needed

Normal:

Wash up to 3 times per day

Minimal:

Wash once per day

Step 4: Determine the Budget per Tray

Ensure that the correct tray has been selected for the right application. Selecting a low cost tray for a heavy application is not the most cost effective option. Tray pricing varies according to the following factors:

Manufacturing process

Material type and grade

Tray size

Personalization options

Warranty

Step 5: Personalization

Cambro offers high quality personalization on most of the trays that we manufacture. Look for the personalization logo throughout the brochure. 

Step 6: Additional Features to Consider

Evaluate the importance of the following features to determine the best tray for your operation.

Stacking lugs - Promote air circulation for fast drying and perfect stacking

Surface impact resistance

Edge breaking resistance

Scratch and stain resistance

Type of Warranty

Technical test descriptions

All Cambro trays are submitted to an array of tests described to the right. The results are indicated on each tray page under Technical Test Results.



Versa Trays



Versa Trays Anitmicrobial



Versa Lite Trays



Laminated Capri Trays



Laminated Corfu Trays



Laminated Mykonos Trays



Fast Food Trays



Tablotherm

TESTS DESCRIPTIONS

Thermal Shock Resistance Test:

Test consists of applying a radical temperature change during a short period of time to the tray, by taking out the tray from icy water (0°C) and placing it into boiling water (100°C) and measuring any deformation.

Break Resistance Test:

Test consists of dropping a metal ball from specific heights onto the tray and measuring any deformation.

Scratch Resistance Test:

Observe scratches and abrasions as a result of friction between porcelain dinnerware and the tray surface.

Test consists of moving a porcelain dish placed on tray from left to right under hand pressure and measuring any abrasion on tray surface.

DISHWASHER SAFE DESCRIPTIONS

Extensive: Wash as often and as frequently as needed.

Normal: Wash up to 3 times per day.

Minimal: Wash once per day.

Tray Product Guide

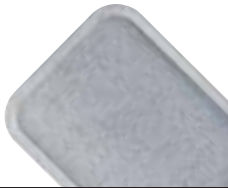
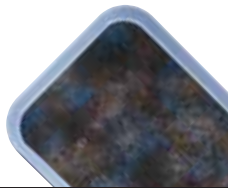
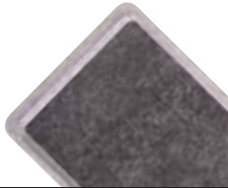
POLYESTER TRAYS				
				
Tray Description	Versa Trays VT/GP Pages 16-17	Antibacterial Versa Trays VT/GP Page 18	Versa Trays with Décor GP Page 19	Non-Slip Surface GP Page 20
Material	SMC-High Performance Fiberglass Reinforced Polyester	SMC-High Performance Fiberglass Reinforced Polyester	SMC-High Performance Fiberglass Reinforced Polyester + Melamine Surface	SMC-High Performance Fiberglass Reinforced Polyester + Non-Slip Surface
Surface	Smooth	Smooth	Smooth	Non-Slip
Performance	Excellent	Excellent	Excellent	Excellent
Recommended Use	(H) (S) (U) (CS) (M)	(H) (S) (U) (CS) (M)	(H) (S) (U) (CS) (M)	(H) (S) (U) (CS) (M)
Personalization	Yes (Heat resistance: 90°C)	No	No	Yes Δ
Years Guaranteed**	5	5	5	2
Stacking* Lugs	Yes	Yes	Yes	Yes
Dishwasher Safe	Yes – Extensive	Yes – Extensive	Yes – Extensive	Yes – Extensive
Chemical Resistance	Excellent	Excellent	Excellent	Good
Drying Test	Excellent	Excellent	Excellent	Excellent
Thermal Shock Resistance	Excellent	Excellent	Excellent	Excellent
Break Resistance	Excellent	Excellent	Excellent	Excellent
Scratch Resistance	Excellent	Excellent	Excellent	Good
Stain Resistance	Excellent	Excellent	Excellent	Good
Heat Resistance	-40° to +140°C ‡	-40° to +140°C ‡	-40° to +90°C ‡	-40° to +80°C ‡
Number of Sizes	22	7	3	4
Number of Shapes	9	3	1	1
Number of Colors	10	1	15	5

*Stacking lugs allow free air circulation and perfect stacking.

** Prorated warranty.

‡ Not recommended for heated cart.

Δ Contact your Cambro representative for pricing.

If you are using Thermo-Chemical Disinfection Equipment, please contact us. We will assist you finding the right tray for your application.

Icon Directory for Recommended Use:



Hospitals



Schools



Universities



Canteens / Cafeterias / Self-Serve



Military



Hotel / Room Service



Banquet Service



Restaurants / Cafes



Bars / Clubs / Pubs



Catering



Brasseries



Prisons / Corrections



Home Meal Delivery



Quick Serve Restaurants



Food Courts / Snack Shops







Deli / Buffet Displays

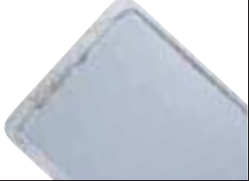

Kitchen Operation

Tray Product Guide

	POLYESTER TRAYS			FIBERGLASS TRAYS
				
Tray Description	Non-Skid Versa Lite Trays VL/GL Page 21	Versa Lite Trays VL/GL Pages 22-23	Versa Lite Trays with Non-Slip Rubber Surface VL/GL Page 24	Camtray Pages 25-27
Material	SMC-Standard Performance Fiberglass Reinforced Polyester + Non-Slip Surface	SMC-Standard Performance Fiberglass Reinforced Polyester	SMC-Standard Performance Fiberglass Reinforced Polyester + Non-Slip Rubber Surface	Fiberglass Layers + Polyester Resin
Surface	Non-Skid	Smooth	Non-Slip Rubber	Smooth
Performance	Excellent	Excellent	Excellent	Excellent
Recommended Use	(S) (U) (CS) (M) (RS)	(H) (S) (U) (CS) (M) (C) (RS)	(BS) (RC) (BC) (C) (B)	(H) (S) (U) (CS) (M) (RS)
Personalization	Yes Δ	Yes (Heat resistance: 90°C)	No	Yes
Years Guaranteed**	2	3	3	5
Stacking* Lugs	Yes	Yes	Yes	Yes
Dishwasher Safe	Yes – Normal	Yes – Normal	Yes – Normal	Yes – Extensive
Chemical Resistance	Good	Good	Good	Good
Drying Test	Excellent	Excellent	Excellent	Excellent
Thermal Shock Resistance	Good	Good	Good	Excellent
Break Resistance	Good	Good	Good	Excellent
Scratch Resistance	Good	Good	Good	Excellent
Stain Resistance	Good	Good	Good	Excellent
Heat Resistance	-40° to +80°C ‡	-40° to +130°C ‡	-40° to +100°C ‡	-10° to +100°C ‡
Number of Sizes	4	21	7	40
Number of Shapes	3	6	3	5
Number of Colors	4	8	2	55

*Stacking lugs allow free air circulation and perfect stacking.

** Prorated warranty.

‡ Not recommended for heated cart.

Δ Contact your Cambro representative for pricing.

If you are using Thermo-Chemical Disinfection Equipment, please contact us. We will assist you finding the right tray for your application.

Materials Review

POLYESTER TRAYS

- VT/GP Trays
- Antimicrobial VT/GP Trays
- VT/GP Trays with Décor (1)
- VT/GP Non-Skid Versa Trays (2)

High performance polyester trays are made of rugged reinforced mat with long fibers and additional fiberglass to provide extremely high

shock-resistance. Colored isophthalic polyester resin offers high chemical and UV-resistance.

- (1) Melamine resin layer on top increases protection against stains, abrasions and scratches.
- (2) The non-slip surface has a guarantee of 2 years against deterioration.

VERSA LITE TRAYS

- VL/GL Trays
- VL/GL Trays with Non-Slip Surface

Standard performance polyester trays are made of fiberglass and standard polyester resin.

Tray Product Guide

	FIBERGLASS TRAYS				WOOD TRAYS	
						
Tray Description	Non-Skid Versa Camtrays® Page 30	Dietary Trays Page 31	Camlite Trays Page 31	Camtread Trays Page 32	Wood Trays with Smooth Surface Page 33	Wood Trays with Non-Slip Surface Pages 33-34
Material	Fiberglass Layers + Polyester Resin + Non-Slip Surface	Fiberglass Layers + Polyester Resin	Fiberglass Layers + Polyester Resin	Fiberglass Layers + Polyester Resin + Non-Slip Rubber Surface	Veneer Beechwood	Veneer Beechwood / Mahogany + Non-Slip Surface
Surface	Non-Slip	Smooth	Smooth	Non-Slip Rubber	Smooth	Non-Slip
Performance	Excellent	Excellent	Excellent	Excellent	Good	Good
Recommended Use	(S) (U) (CS) (M) (RS)	(H) (S) (U) (GS) (M) (RS)	(H) (S) (U) (GS) (M) (RS)	(BS) (RC) (BC) (C) (B)	(BS) (RC) (C)	(BS) (RC) (BC) (C) (B)
Personalization	Yes Δ	No	No	No	No	Yes
Years Guaranteed**	2	3	3	5	3	3
Stacking* Lugs	Yes	Yes	Yes	Yes	No	No
Dishwasher Safe	Yes – Extensive	Yes – Extensive	Yes – Extensive	Yes – Extensive	Yes – Normal	Yes – Minimal
Chemical Resistance	Good	Good	Good	Good	Excellent	Good
Drying Test	Excellent	Excellent	Excellent	Excellent	Good	Good
Thermal Shock Resistance	Excellent	Excellent	Excellent	Excellent	Good	Good
Break Resistance	Excellent	Good	Good	Good	Good	Good
Scratch Resistance	Good	Good	Good	Excellent	Good	Good
Stain Resistance	Good	Excellent	Excellent	Good	Good	Good
Heat Resistance	-40° to +80°C ‡	-10° to +100°C ‡	-10° to +100°C ‡	-10° to +100°C ‡	-10° to +100°C ‡	-10° to +100°C ‡
Number of Sizes	3	7	9	16	14	22
Number of Shapes	4	1	1	4	4	4
Number of Colors	3	58	8	8	1	2

* Stacking lugs promote air circulation and perfect stacking.

Δ Contact your Cambro representative for pricing.

‡ Not recommended for heated cart.

** Prorated warranty.

Materials Review

FIBERGLASS TRAYS

- Camtray
- Non-Skid Versa Camtray
- Dietary Trays
- Camlite Trays
- Market Trays
- Camtread Trays

Made of rugged fiberglass interior to provide a tough inner foundation

and smooth surface, coupled with polyester resin to resist impact, stains and chemicals.

Guaranteed for 5 years.







Camtread Trays molded in non-slip rubber surface are guaranteed 5 years against delamination.

WOOD TRAYS

- Smooth Surface
- Clear Non-Slip Surface

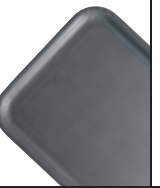
Made of several layers of genuine beechwood veneer / mahogany combined with synthetic resin molded under high pressure and temperature. The surface is sealed with a double layer of high pressure melamine to allow regular washing.

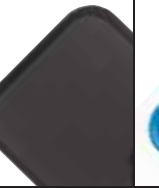
Tray Product Guide

	LAMINATED TRAYS				POLYPROPYLENE TRAYS		SERVICE TRAYS
							
Tray Description	Corfu Laminated Trays with Non-Slip Rubber Surface Page 35	Capri Laminated Trays with Smooth Surface Pages 36-37	Mykonos Laminated Trays with Non-Slip Surface Page 38	Madeira Laminated Trays with Textured Wood Surface Page 39	Fast Food Trays Page 40	Polytread® Trays Page 41	Polycarbonate Trays Page 42
Material	Laminate + Non-Slip Rubber Surface	Laminate	Laminate + Non-Slip Surface	Laminate	Polypropylene	Polypropylene + Non-Slip Rubber Surface	Polycarbonate
Surface	Rubber Non-Slip	Smooth	Non-Slip	Textured	Textured	Non-Slip	Textured
Performance	Excellent	Good	Good	Good	Good	Good	Excellent
Recommended Use	CS BS RC BC C	CS RS RC BC C B	BS RC BC C	CS RS RC BC	QS FC	RS RC BC	S U CS M QS FC
Personalization	Yes†	Yes	Yes	No	Yes	No	No
Years Guaranteed**	3	3	3	3	3	3	3
Stacking* Lugs	No	No	No	No	Yes	Yes	Yes
Dishwasher Safe	Yes – Normal	Yes – Normal	Yes – Minimal	Yes – Normal	Yes – Minimal	Yes – Minimal	Yes – Extensive
Chemical Resistance	Excellent	Excellent	Good	Excellent	Excellent	Good	Good
Drying Test	Good	Good	Good	Good	Good	Good	Excellent
Thermal Shock Resistance	Good	Good	Good	Good	Good	Good	Excellent
Break Resistance	Good	Good	Good	Good	Good	Good	Excellent
Scratch Resistance	Good	Good	Good	Good	Good	Good	Very Good
Stain Resistance	Good	Excellent	Good***	Excellent	Good	Good	Very Good
Heat Resistance	-10° to +100°C ‡	-10° to +100°C ‡	-10° to +100°C ‡	-10° to +100°C ‡	-10° to +80°C ‡	-10° to +80°C ‡	-10° to +99°C ‡
Number of Sizes	8	22	15	9	3	22	4
Number of Shapes	2	5	3	4	2	4	2
Number of Colors	2	11	6	4	17	2	6

* Stacking lugs allow free air circulation and perfect stacking

** Prorated warranty.

*** Limited stain resistance for Birch (E75).

‡ Not recommended for heated cart.

† Only back side of Corfu trays can be personalized.

Materials Review

LAMINATED TRAYS

- Corfu*
- Mykonos
- Capri
- Madeira

Made of compressed layers of melamine saturated paper combined with synthetic resin molded under high pressure and temperature.

The surface is sealed with a double layer of high pressure melamine to allow regular washing.

* Non-slip rubber surface bonded directly into tray will not delaminate.

Note: All laminated trays must be dried before stacking.

POLYPROPYLENE TRAYS

- Fast Food Trays
- Polytread® Trays







Fast food trays have a textured surface to hide scratches and provides an additional grip to prevent slipping. Polytread trays have non-slip rubber surface bonded directly into the tray which will not delaminate.

SERVICE TRAYS

- Polycarbonate Trays

Made of highly durable, virtually unbreakable polycarbonate.

Tray Product Guide

	INSULATED TRAYS	COMPARTMENT TRAYS				DISPLAY TRAYS / UTILITY TRAYS	
							
Tray Description	Tablotherm Insulated Trays Page 48	Polycarbonate Trays Pages 42-43	ABS Page 44	Co-Polymer Trays Pages 44-45	Heat Resistant Trays Page 46	Market Trays Page 47	V-Series Tray Page 47
Material	Polypropylene + Foam Insulation	Polycarbonate	ABS	Co-Polymer	Heat Resistant Plastic	Fiberglass Layers + Polyester Resin	SMC - High Performance Reinforced Polyester
Surface	Smooth	Textured	Textured	Textured	Textured	Smooth	Smooth
Performance	Excellent	Excellent	Excellent	Excellent	Excellent	Excellent	Excellent
Recommended Use	(H) (RS) (C) (HD)	(S) (U) (M) (P)	(S) (U) (M) (P)	(S) (U) (HD) (P)	(P)	(D)	(K)
Personalization	No	No	No	No	No	No	Yes
Years Guaranteed**	3	3	3	3	3	3	5
Stacking* Lugs	Locking ridges for secure stacking	Yes	Yes	Yes	Yes	Yes	Yes
Dishwasher Safe	Yes	Yes – Extensive	Yes – Extensive	Yes – Minimal	Yes – Extensive	Yes – Extensive	Yes – Extensive
Chemical Resistance	Good	Good	Excellent	Excellent	Very Good	Good	Excellent
Drying Test	Good	Excellent	Excellent	Excellent	Very Good	Excellent	Excellent
Thermal Shock Resistance	Good	Excellent	Good	Good	Very Good	Excellent	Excellent
Break Resistance	Good	Excellent	Good	Good	Very Good	Good	Excellent
Scratch Resistance	Good	Very Good	Very Good	Very Good	Very Good	Good	Excellent
Stain Resistance	Good	Very Good	Very Good	Very Good	Very Good	Excellent	Excellent
Heat Resistance	-10° to +100°C ‡	-40° to +99°C ‡	-10° to +82°C ‡	-10° to +80°C ‡	-40° to +190°C	-10° to +100°C ‡	-40° to +100°C ‡
Number of Sizes	3	11	1	7	2	19	1
Number of Shapes	1	12	1	5	1	1	1
Number of Colors	3	14***	7	7	1	9	1

* Stacking lugs allow free air circulation and perfect stacking

** Prorated warranty.

*** Not available for all tray styles.

‡ Not recommended for heated cart.

Materials Review

INSULATED TRAYS

– Tablotherm

Made of polypropylene inner shell injected with polyurethane foam for insulation.

COMPARTMENT TRAYS

– Polycarbonate Trays

Made of highly durable, virtually unbreakable polycarbonate.

– ABS Trays

Made of high impact resistance and heat and chemical resistance ABS.

– Co-Polymer Trays

Made of economical pliable and break-resistant co-polymer.

– Heat resistant Trays

Made of heat resistant material. Oven (up to 190°C) and microwave safe. Ideal for heated carts or cook-chill process.

SMC TRAYS

– V-Series Tray

All purpose tray to assist in kitchen operations. Made of fiberglass and standard resin polyester. Microwave safe.

Personalization

Value Added Personalization

Promote business to customers and employees alike by placing your custom logo, trademark, slogan or design on our trays.

How to Order

- 1) Select a tray size, color, pattern, or design.
- 2) Provide complete, camera-ready artwork and indicate positioning on the tray.
- 3) According to the tray type, Cambro can produce 1, 2, 3 and 4 color artwork as well as 4 color process artwork.

We require the following:

a. Electronic artwork file provided on CD-ROM for Mac or PC.

We accept the following file formats:

- Adobe Illustrator, Adobe Photoshop file in JPEG, TIFF or EPS formats.

- File dimensions must equal 100% of reproduction size at 300dpi resolution.

b. Illustration on paper: The quality of the art must be crisp and scannable. Please specify PANTONE number for each color or indicate if it is a four color process.

4) An artist's fee of *** per hour will be charged to any order submitted

without complete, camera-ready artwork. Cambro will contact you if this fee will be charged and will give you an estimated cost.

5) Sample process:

a. For any new project, a finished sample will be submitted for the customer's approval.

b. The first sample with a firm purchase order is free. (Plus shipping cost.)

c. Samples not accompanied by a firm purchase order or requests for more than one sample will be charged a flat rate of:

– Polyester, Fiberglass and Laminated Trays:

*** Net per sample. (Plus shipping cost.)

– Polypropylene Fast Food Trays: *** Net per sample. (Plus shipping cost.)

d. Upon receipt and shipment of a firm purchase order, a credit will be applied to your account for the cost of one sample.

6) Personalization charges apply to both original orders and returns.

POLYESTER TRAYS

Versa Trays VT/GP (pages 16-17)

Versa Lite Trays VL/GL (pages 22-23)

- Only the following tray models are suitable for personalization:

Versa Trays:

VT1216, VT1418, VT2632, VT3253, VT3343, VT3343C, VT3646C, VT3753, VT3853, GP0540, GP1070, GP1080, GP3074, GP3980, GP4002, GP4210, GP4004, GP4701, GP4709, GP4853

Versalite Trays:

VL1014, VL1216, VL1418, VL2632, VL3253, VL3343, VL3343C, VL3646C, VL3753, GL0540, GL1070, GL1080, GL3074, GL3980, GL4002, GL4210, GL4701, GL4709

- **Minimum Quantity:** 120 trays per size.
- **Sample Production Time:** 10 business days + delivery and transit time from receipt of camera ready artwork.
- **Order Production Time:** Up to 4-6 weeks + delivery and transit time from the date artwork is approved and the order is confirmed.
- Request for additional samples without a firm purchase order will be charged *** Net per sample. (Plus shipping cost).

Printing Process Applicable:

Four Color Printing Process allows printing of one color or multiple color artwork as well as photo reproduction.

Tray Colors Recommended for Personalized Versa Trays VT/GP:

Pearl White (A33), Light Grey (A27), Terrazzo (A86), Granite (A83), Sahara (A22), Speckled Mocha (A21).

For the following colors, please call Cambro Customer Service for artwork review: Magic Blue (A24), Magic Yellow (A25), Magic Mint (A26).

Tray Colors Recommended for Personalized Versa Lite Trays VL/GL:

Speckled Sand (A08), Speckled Smoke (A20), Speckled Mocha (A21), Sahara (A22), Light Grey (A27), Pearl White (A33) and Terrazzo (A86).

Printable Area:

The artwork can cover the flat surface of tray up to 1 cm from the internal tray edge.

Personalization Charges Per Tray:

QUANTITY EACH	ADDITIONAL NET CHARGES
120-300	***
312-996	***
1,008 and up	***

*** Contact your Cambro representative for pricing



FIBERGLASS TRAYS

Camtray® Trays (pages 25-27)

- All Camtray sizes can be personalized. (Except compartment trays shown in main Cambro catalog).

- **Minimum Quantity:**

Screen Printing Process: 144 trays per size.

Four Color Printing Process: 72 trays per size.

- **Sample Production Time:** 10 business days + delivery and transit time from receipt of camera ready artwork.

- **Order Production Time:** Up to 4-6 weeks + delivery and transit time from the date artwork is approved and the order is confirmed.

- Request for additional samples without a firm purchase order will be charged *** Net per sample. (Plus shipping cost).

Printing Process Applicable: Screen printing process and four color process.

a. Screen printing process allows printing of artwork with one or multiple colors laying next to each other. This process doesn't allow printing of gradient or photo reproduction. This process is best used with light color artwork on dark tray color.

Printable area: The artwork can cover the total surface of the tray from one edge to the other.

b. Four Color Printing Process allows printing of one color or multiple color artwork as well as photo reproduction. This process can only be used on light color trays. Darker tray color will make the artwork colors go darker.

Tray Colors Recommended for Four Color Printing Process:

Antique Parchment (101), Light Peach (106), Dark Peach (117), White (148), Sky Blue (177), Key Lime (429), Lemon Chiffon (536), Cameo Yellow (537), Cottage White (538).

Printable area: The artwork can cover the flat surface of tray up to 1 cm from the internal tray edge.

Personalization Charges Per Tray:

QUANTITY EACH	ADDITIONAL NET CHARGES
72*-144**	***
145-288	***
289-432	***
433 and up	Free

* Minimum quantity for four color printing process

** Minimum quantity for screen printing process

*** Contact your Cambro representative for pricing



1418

Personalization

LAMINATED TRAYS

Corfu (page 35) Capri (pages 36-37) Mykonos (page 38) Madeira (page 39)

- All Laminated tray sizes can be personalized or produced in any custom color. Custom color matching is treated as a personalization.
- Top and bottom parts of trays can be personalized with the exception of Corfu trays that can only be personalized on the backside of the tray. Personalization cost is per side of the tray.
- **Minimum Quantity:** 120 trays per size.



- **Sample Production Time:** 10 business days + delivery and transit time from receipt of camera ready artwork.
- **Order Production Time:** Up to 4-6 weeks + delivery and transit time from the date artwork is approved and the order is confirmed.

- Request for additional samples without a firm purchase order will be charged *** Net per sample. (Plus shipping cost.)

Printing Process Applicable: Four color process and Custom Color Matching

a. Four Color Printing Process: This process allows the printing of one color or multiple color artwork as well as photo reproduction.

b. Custom Color Matching: Custom color matching is treated as a personalization. To produce any color tray provide Cambro with PANTONE number.

Printable area: The artwork can cover the total surface of tray from one edge to the other. Artwork dimensions must be 4 cm bigger than tray sizes on each side due to trimming. (example: Tray size: 36 x 46 cm – Artwork size: 40 x 50 cm).

Personalization Charges Per Tray:

QUANTITY EACH	ADDITIONAL NET CHARGES
120-288	***
312-2,400	***
2,424 and up	***

*** Contact your Cambro representative for pricing

POLYPROPYLENE TRAYS

Fast Food Trays (page 40)

- All Fast Food tray sizes can be personalized except 1217FFH.
- **Minimum Quantity:** 288 trays per size.
- **Sample Production Time:** 10 business days + delivery and transit time from receipt of camera ready artwork.
- **Order Production Time:** Up to 4-6 weeks + delivery and transit time



from the date artwork is approved and the order is confirmed.

- Request for additional samples without a firm purchase order will be charged *** Net per sample. (Plus shipping cost.)

Printing Process Applicable:

Hot stamp 1 color process. Due to the application process onto textured tray surface, white can be selected but is not recommended.

Printable area: Artwork cannot exceed a maximum size of 15 x 15 cm.

Personalization Cost:

One-time die charge: *** Net per order.

Additional Net Charges Per Tray:

QUANTITY EACH	ADDITIONAL NET CHARGES
288-767	***
768-1,199	***
1,200-5,999	***
6,000-11,999	***
12,000 and up	***

*** Contact your Cambro representative for pricing.

CAMTREAD TRAYS

Tray Back Personalization and Rubber Surface Embossing

- **Camtread From USA:** Sizes Available: All Camtread sizes.
- **Camtread From Europe:** Sizes Available: 1100CT, 1400CT, 1600CT and 1800CT
- **Sample Production Time:** 10 business days + delivery and transit time from receipt of camera ready artwork.
- **Order Production Time:** Up to 4-6 weeks + delivery and transit time from the date artwork is approved and the order is confirmed.
- Request for additional samples without a firm purchase order will be charged *** Net per sample. (Plus shipping cost).



Tray Back Personalization Printing Process Applicable:

Four Color Printing Process allows printing of one color or multiple color artwork as well as photo reproduction.

Camtread From USA: White trays are recommended for tray back personalization.

Printable area: The artwork can cover the flat surface of tray up to 2,54 cm from the external tray edge.

Personalization Charges Per Tray:

QUANTITY EACH	ADDITIONAL NET CHARGES
Camtread From USA	
72-144	***
145-288	***
289-432	***
433 and up	Free
Camtread From Europe	
120-996	***
1,008 and up	***

Rubber Surface Embossing

- **Electronic File Format:** Adobe Illustrator EPS formats.

Embossing Process Printable Area: The artwork can cover the surface of the tray up to 2,54 cm from the internal tray of edge.

Embossing Personalization Charge Per Tray:

QUANTITY EACH	ADDITIONAL NET CHARGES
Camtread From USA	
72 and up	***
Camtread From Europe	
156 and up	***

*** Contact your Cambro representative for pricing.

Polyester Versa Trays with Smooth Surface

SPECIFICATIONS

Material	SMC – High Performance Fiberglass Reinforced Polyester
Surface Characteristic	Smooth
Performance	Excellent
Stacking Lugs	Yes
Dishwasher Safe	Yes – Extensive
Chemical Resistance	Excellent
Drying Test	Excellent
Shock Resistance	Excellent
Break Resistance	Excellent
Scratch Resistance	Excellent
Stain Resistance	Excellent
Heat Resistance*	-40° to +140°C ‡



‡ Not for use in heated carts.
Personalization, see page 14.
* Personalization Heat Resistance: 90°C.

CODE	DIA/ SIZE (CM)	CASE PACK	CASE KG. (CUBE M ³)
Versa Trays – High Profile Shape			
VT1216	30,5 x 41,5	12	7,8 (0,014)
VT1418	35,5 x 45,7	12	10,0 (0,020)
VT3343	33,0 x 43,0	12	8,7 (0,016)

CODE	DIA/ SIZE (CM)	CASE PACK	CASE KG. (CUBE M ³)
Versa Trays – Low Profile Shape			
VT2632	32,5 x 26,5	12	5,5 (0,009)
VT3253	32,5 x 53,0	12	11,0 (0,020)
VT3753	37,0 x 53,0	12	11,8 (0,022)
VT3853	37,5 x 53,0	12	12,3 (0,022)

CODE	DIA/ SIZE (CM)	CASE PACK	CASE KG. (CUBE M ³)
Versa Century™ Trays – low Profile Design Shape			
VT3646C	35,5 x 45,7	12	8,8 (0,013)
VT3343C	32,9 x 42,9	12	8,7 (0,016)



VT3646C

Innovative low profile and low corner design increases space utilization of tray surface and customer comfort while eating.

RECOMMENDED USE

High Traffic / Frequent Use

- Hospitals
- Schools
- Universities
- Canteens / Cafeterias / Self-Serve
- Military

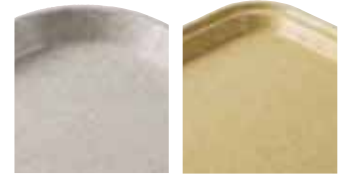

High Profile Shape

Low Profile Shape



Low Profile Design Shape

Flat Edge Shape

Versa Trays – High Profile Shape



VT1418

Versa Trays – Low Profile Shape



VT3753

Versa Century Trays – Low Profile Design Shape



VT3646C

Polyester Versa Trays with Smooth Surface

CODE	DIA/ SIZE (CM)	CASE PACK	CASE KG. (CUBE M ³)
Versa Trays – Flat Edge Shape			
GP0540*	46,0 x 34,4	12	9,2 (0,019)
GP1070*	32,5 x 26,5	12	5,3 (0,009)
GP1080*	37,0 x 26,5	12	5,5 (0,010)
GP3074	45,0 x 32,0	12	7,5 (0,010)
GP3980*	53,0 x 37,0	12	11,3 (0,020)
GP4002*	53,0 x 32,5	12	10,0 (0,019)
GP4004**	53,0 x 32,5	12	10,0 (0,019)
GP4701	42,5 x 32,5	12	7,1 (0,010)
GP4709	46,0 x 32,5	12	8,1 (0,012)
GP4856*	34,5 x 23,0	12	4,5 (0,006)

* Designed with reinforced corners for automatic off-stacking onto conveyor belt dishwashers.

**Textured top surface to reduce sliding of dishes. Not available in (A72).

Versa Trays – Flat Edge Shape



Tray Colors:



A21
Speckled Mocha



A22
Sahara



A25
Magic Yellow



A26
Magic Mint



A27
Light Grey



A33
Pearl White



A36
Speckled Blue



A72
Charcoal*



A83
Granite



A86
Terrazzo

CODE	DIA/ SIZE (CM)	CASE PACK	CASE KG. (CUBE M ³)
Versa Trays – Café Trays			
GP55653	40,0 x 27,0	12	6,0 (0,009)
GP55702	26,0 x 20,0	12	2,0 (0,003)
GP55703	29,0 x 21,0	12	2,5 (0,003)

Versa Trays – Café Trays



CODE	DIA/ SIZE (CM)	CASE PACK	CASE KG. (CUBE M ³)
Versa Trays – Space Saver Trays			
GP4210	48,0 x 34,0	12	7,4 (0,018)
GP4853	42,4 x 32,5	12	7,0 (0,009)

Versa Trays – Space Saver Trays



Hexagonal table
Lateral side:
70 cm GP4210



Square table
80 x 80 cm
GP4210



Round table
Diam. 135 cm
GP4853



Square Table
95 x 95 cm
GP4853

Polyester Versa Trays VT/GP are not recommended for use in heated meal delivery carts. Please contact Cambro Customer Service or Presswerk Köngen GmbH, with any questions related to proper usage or any special application. Cambro will provide you with clear instructions on correct usage of our trays to ensure you get the maximum life out of our products.

*Charcoal color A72 will show scratches if not handled properly.

Microban® Antibacterial Camguard® Versa Trays

SPECIFICATIONS

Material	SMC – High Performance Fiberglass Reinforced Polyester
Surface Characteristic	Smooth
Performance	Excellent
Stacking Lugs	Yes
Dishwasher Safe	Yes – Extensive
Chemical Resistance	Excellent
Drying Test	Excellent
Shock Resistance	Excellent
Break Resistance	Excellent
Scratch Resistance	Excellent
Stain Resistance	Excellent
Heat Resistance	-40° to +140°C‡



PRORATED

‡ Not for use in heated carts.

RECOMMENDED USE

High Traffic / Frequent Use
– Hospitals
– Schools
– Universities
– Canteens / Cafeterias / Self-Serve
– Military



High Profile Shape

Low Profile Design Shape



Flat Edge Shape

CAMGUARD
ANTIBACTERIAL



Built-in Antimicrobial Protection from Microban Eliminates Bacteria

Microban 3G-Silver™ is built into every Cambro Camguard Versa Tray to protect against the harmful effects of bacteria. Microban eliminates existing bacteria and prevents the growth of new bacteria. This protection cannot be washed off and does not wear away over time. This built-in defense lasts for the life of the tray.

Unprotected Surface versus Microban 3G-Silver™ Treated Surface 24 Hour Test

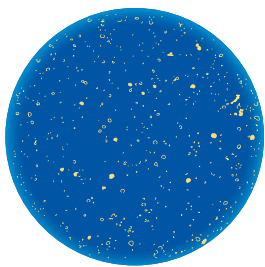

Untreated

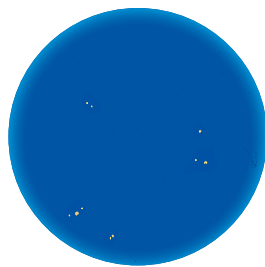

Treated with Microban®

CODE	DIMENSIONS (CM)	CASE KG. (CUBE M ³)
Versa Trays – High Profile Shape		
VT1418AB	35,5 x 45,7	8,8 (0,013)
VT3343AB	33,0 x 43,0	8,7 (0,016)
Versa Century™ Trays – Low Profile Design Shape		
VT3646CAB	35,5 x 45,7	8,8 (0,013)
VT3343CAB	32,9 x 42,9	8,7 (0,016)
Versa Trays – Flat Edge Shape		
GP1070AB*	32,5 x 26,5	5,3 (0,009)
GP1080AB*	37,0 x 26,5	5,5 (0,01)
GP3980AB*	53,0 x 37,0	11,3 (0,02)
GP4002AB*	53,0 x 32,5	10,0 (0,019)

Case Pack: 12

* Designed with reinforced corners for automatic off-stacking into conveyor belt dishwashers.



Innovative low profile and low corner design increases space utilization of tray surface and customer comfort while eating.



Reinforced polyester corners provide superior corner and edge protection against impact.



Stacking lugs allow free air circulation for fast drying and perfect stacking.

Tray Color:



A83

Granite

Polyester Decorated Versa Trays with Smooth Surface

SPECIFICATIONS

Material	SMC – High Performance Fiberglass Reinforced Polyester + Melamine Surface
Surface Characteristic	Smooth
Performance	Excellent
Stacking Lugs	Yes
Dishwasher Safe	Yes – Extensive
Chemical Resistance	Excellent*
Drying Test	Excellent
Shock Resistance	Excellent
Break Resistance	Excellent
Scratch Resistance	Excellent
Stain Resistance	Excellent
Heat Resistance	-40° to +90°C‡



‡ Not for use in heated carts.

* If you are using Thermo-Chemical Disinfection Equipment, please contact us. We will assist you finding the right tray for your application.

RECOMMENDED USE

High Traffic / Frequent Use
– Hospitals
– Schools
– Universities
– Canteens / Cafeterias / Self-Serve
– Military



Flat Edge Shape



CODE	DIA/ SIZE (CM)	CASE PACK	CASE KG. (CUBE M³)
Versa Trays – Flat Edge Shape			
GP0540*	46,0 x 34,4	12	9,2 (0,019)
GP3980*	53,0 x 37,0	12	11,3 (0,020)
GP4002*	53,0 x 32,5	12	10,0 (0,019)
GP4004	53,0 x 32,5	12	10,0 (0,019)

* Designed with reinforced corners for automatic off-stacking onto conveyor belt dishwashers.

Patterns and Tray Base Colors:



B98
Pebbled Grey on
Terrazzo Tray



B21
Graffiti on
Light Grey Tray



B99
Pebbled Black on
Light Grey Tray

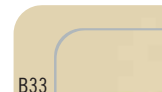

B33
Pearl White on
Pearl White Tray



B27
Light Grey on
Light Grey Tray

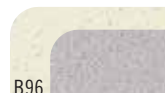

B96
Pebbled White on
Terrazzo Tray

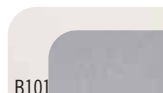

B101
Brushed Steel on
Light Grey Tray



B100
Pebbled Black on
Terrazzo Tray



B102
Brushed Steel on
Terrazzo Tray



B93
Titan on
Granite Tray

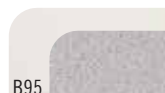

B95
Pebbled White on
Light Grey Tray



B97
Pebbled Grey on
Light Grey Tray

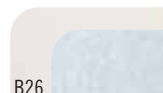

B26
Aqua on
Light Grey Tray

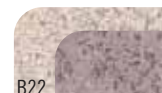

B22
Sahara on
Sahara Tray

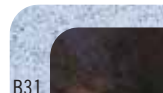

B31
Lava on
Speckled Blue Tray

Polyester Decorated Versa Trays with Non-Slip Surface

SPECIFICATIONS

Material	SMC – High Performance Fiberglass Reinforced Polyester + Non-Slip Surface
Surface Characteristic	Non-Slip
Performance	Excellent
Stacking Lugs	Yes
Dishwasher Safe	Yes - Extensive
Chemical Resistance	Good
Drying Test	Excellent
Shock Resistance	Excellent
Break Resistance	Excellent
Scratch Resistance	Good
Stain Resistance	Good
Heat Resistance	-40° to +80°C‡



‡ Not for use in heated carts.

Personalization: Contact your Cambro representative for pricing.

RECOMMENDED USE

High Traffic / Frequent Use
– Hospitals
– Schools
– Universities
– Canteens / Cafeterias / Self-Serve
– Military



Flat Edge Shape

CODE	DIA/ SIZE (CM)	CASE PACK	CASE KG. (CUBE M ³)
Versa Trays – Flat Edge Shape			
GP3980NS*	53,0 x 37,0	12	11,3 (0,020)
GP4002NS*	53,0 x 32,5	12	10,0 (0,019)
GP0540NS*	46,0 x 34,4	12	9,2 (0,019)
GP1080NS*	37,0 x 26,5	12	5,5 (0,010)

* Designed with reinforced corners for automatic off-stacking onto conveyor belt dishwashers.



Patterns and Tray Base Colors:



B22
Sahara on Sahara Tray



B93
Titan on Granite Tray

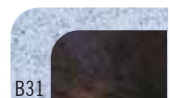

B31
Lava on Speckled Blue Tray

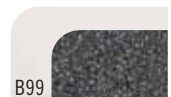

B99
Pebbled Black on Light Grey Tray



B100
Pebbled Black on Terrazzo Tray

Non-Skid Versa Lite Trays

SPECIFICATIONS

Material	SMC – High Performance Fiberglass Reinforced Polyester + Non-Slip Surface
Surface Characteristic	Non-Slip
Performance	Excellent
Stacking Lugs	Yes
Dishwasher Safe	Yes - Extensive
Chemical Resistance	Good
Drying Test	Excellent
Shock Resistance	Excellent
Break Resistance	Excellent
Scratch Resistance	Good
Stain Resistance	Good
Heat Resistance	-40° to +80°C‡



‡ Not for use in heated carts.

Personalization: Contact your Cambro representative for pricing.



RECOMMENDED USE

Intensive Use / Economic Priority
– Hospitals
– Schools
– Universities
– Canteens / Cafeterias / Self-Serve
– Military
– Catering / Cruise Ships
– Hotels / Room Service

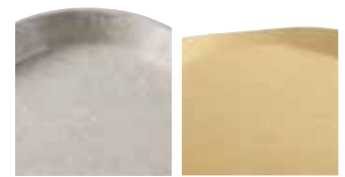

High Profile Shape

Low Profile Design Shape



Flat Edge Shape



Reinforced polyester corners provide superior corner and edge protection against impact.



Stacking lugs allow free air circulation for fast drying and perfect stacking.



Versa Lite Century Trays have low edges and ergonomic corners that enhance comfort.

Tray Colors:

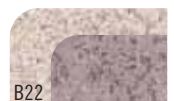

B22

Sahara on Sahara Tray



B14

Titan on Speckled Smoke Tray



B11

Sahara on Pearl White Tray



B99

Pebbled Black on Light Grey Tray

CODE	DIMENSIONS (CM)	CASE KG. (CUBE M ³)
Versa Trays – High Profile Shape		
VL1418NS	35,5 x 45,7	10,0 (0,020)
VL3343NS	33,0 x 43,0	8,7 (0,016)
Versa Century™ Trays – Low Profile Design Shape		
VL3646CNS	35,5 x 45,7	8,8 (0,013)
VL3343CNS	33,0 x 43,0	8,7 (0,016)
Versa Trays – Flat Edge Shape		
GL3980NS*	53,0 x 37,0	11,3 (0,020)
GL4002NS*	53,0 x 32,5	10,0 (0,019)

Case Pack: 12.

* Designed with reinforced corners for automatic off-stacking onto conveyor belt dishwashers.



Non-Skid Trays grip firmly providing safer meal delivery service.

Polyester Versa Lite Trays with Smooth Surface

SPECIFICATIONS

Material	SMC – Standard Performance Fiberglass Reinforced Polyester
Surface Characteristic	Smooth
Performance	Excellent
Stacking Lugs	Yes
Dishwasher Safe	Yes – Normal
Chemical Resistance	Good
Drying Test	Excellent
Shock Resistance	Good
Break Resistance	Good
Scratch Resistance	Good
Stain Resistance	Good
Heat Resistance*	-40° to +130°C‡



‡ Not for use in heated carts.
Personalization, see page 14.
* Personalization Heat Resistance: 90°C.

RECOMMENDED USE

Moderate Traffic / Economic Priority

- Schools
- Universities
- Canteens / Cafeterias / Self-Serve
- Military
- Hotel Room Service

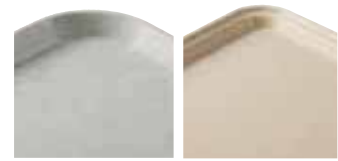

High Profile Shape Low Profile Shape

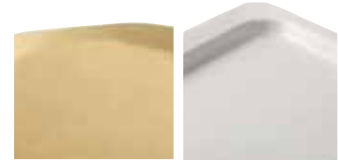

Low Profile Design Shape Flat Edge Shape



Low Profile Flat Edge Shape

CODE	DIA/ SIZE (CM)	CASE KG. (CUBE M ³)
Versa Lite Trays – Flat Edge Shape		
GL0540†	46,0 x 34,4	9,2 (0,019)
GL1070†	32,5 x 26,5	5,3 (0,009)
GL1080†	37,0 x 26,5	5,5 (0,010)
GL3074	45,0 x 32,0	7,5 (0,010)
GL3980†	53,0 x 37,0	11,3 (0,020)
GL4002†	53,0 x 32,5	10,0 (0,019)
GL4060	40,0 x 60,0	13,0 (0,022)
GL4701	42,5 x 32,5	7,1 (0,010)
GL4709	46,0 x 32,5	8,1 (0,012)

Case Pack: 12

† Designed with reinforced corners for automatic off-stacking onto conveyor belt dishwashers.

Versa Lite Trays – Flat Edge Shape



GL1080



GL4002

CODE	DIA/ SIZE (CM)	CASE KG. (CUBE M ³)
Versa Lite Trays – High Profile Shape		
GL4210	48,0 x 34,0	7,4 (0,018)

Case Pack: 12

Versa Lite Trays – Space Saver Trays



Hexagonal table
Lateral side:
70 cm GL4210



Square table
80 x 80 cm
GL4210



GL4210

Polyester Versa Lite Trays with Smooth Surface

CODE	DIA/ SIZE (CM)	CASE KG. (CUBE M ³)
Versa Lite Trays – High Profile Shape		
VL1014	27,0 x 35,0	5,6 (0,007)
VL1216	30,5 x 41,5	7,8 (0,014)
VL3343	33,0 x 43,0	8,7 (0,016)
VL1418	35,5 x 45,7	10,0 (0,020)

Case Pack: 12

Versa Lite Trays – High Profile Shape



VL1418

CODE	DIA/ SIZE (CM)	CASE KG. (CUBE M ³)
Versa Lite Trays – Low Profile Flat Edge Shape		
GL220P	32,5 x 53,0	11,0 (0,020)
GL210P	37,0 x 53,0	11,8 (0,022)

Case Pack: 12

New!

Versa Lite Trays – Low Profile Flat Edge Shape



CODE	DIA/ SIZE (CM)	CASE KG. (CUBE M ³)
Versa Lite Trays – Low Profile Shape		
VL2632	32,5 x 26,5	5,5 (0,009)
VL3253	32,5 x 53,0	11,0 (0,020)
VL3753	37,0 x 53,0	11,8 (0,022)

Case Pack: 12

Versa Lite Trays – Low Profile Shape



CODE	DIA/ SIZE (CM)	CASE KG. (CUBE M ³)
Versa Lite Century™ Trays – Low Profile Design Shape		
VL3646C	35,5 x 45,7	8,8 (0,013)
VL3343C	32,9 x 42,9	8,7 (0,016)

Case Pack: 12

Versa Lite Century Trays – Low Profile Design Shape



Innovative low profile and low corner design increases space utilization of tray surface and customer comfort while eating.

Tray Colors:

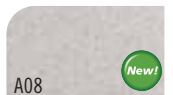

Polyester Versa Lite Trays with Non-Slip Rubber Surface

SPECIFICATIONS

Material	SMC – Standard Performance Fiberglass Reinforced Polyester + Non-Slip Rubber
Surface Characteristic	Non-Slip Rubber
Performance	Excellent
Stacking Lugs	Yes
Dishwasher Safe	Yes – Normal
Chemical Resistance	Good
Drying Test	Excellent
Shock Resistance	Good
Break Resistance	Good
Scratch Resistance	Good
Stain Resistance	Good
Heat Resistance	-40° to +100°C‡

RECOMMENDED USE

Moderate Traffic / Economic Priority

- Banquet Service
- Restaurant / Cafes
- Bars / Clubs / Pubs
- Catering
- Brasseries

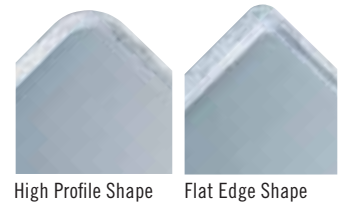

‡ Not recommended for heated carts.



CODE	DIA/ SIZE (CM)	CASE PACK	CASE KG. (CUBE M ³)
Versa Lite Trays – High Profile Shape			
VL1418RNS	35,5 x 45,7	12	10,0 (0,020)
Versa Lite Trays – Flat Edge Shape			
GL1070RNS*	32,5 x 26,5	12	5,3 (0,009)
GL4002RNS*	53,0 x 32,5	12	10,0 (0,019)
GL3980RNS*	53,0 x 37,0	12	11,3 (0,020)
Versa Lite Tray – Cafe Trays			
VL2129RNS	21,0 x 29,0	12	2,91 (0,01)
VL3200RNS	∅ 32,0	12	6,37 (0,02)
VL3600RNS	∅ 36,0	12	9,06 (0,02)

* Designed with reinforced corners for automatic off-stacking onto conveyor belt dishwashers.



Patterns and Tray Base Colors:



A87
Black

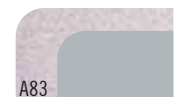

A83

Grey on
Granite Tray

Camtrays® Fiberglass Trays with Smooth Surface

SPECIFICATIONS

Material	Fiberglass Layers + Polyester Resin
Surface Characteristic	Smooth
Performance	Excellent
Stacking Lugs	Yes
Dishwasher Safe	Yes – Extensive
Chemical Resistance	Good
Drying Test	Excellent
Shock Resistance	Excellent
Break Resistance	Excellent
Scratch Resistance	Excellent
Stain Resistance	Excellent
Heat Resistance	-10° to +100°C‡

‡ Not for use in heated carts.
Personalization, see page 14.

RECOMMENDED USE

High Traffic / Frequent Use
– Hospitals
– Schools
– Universities
– Canteens / Cafeterias / Self-Serve
– Military
– Hotel Room Service

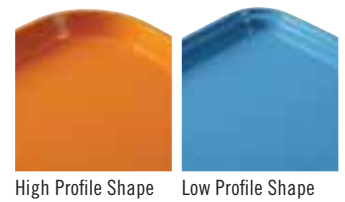

High Profile Shape Low Profile Shape

† Available in Group I colors and patterns and Group III patterns.

Δ Available in Group I colors and patterns except Doily.

* Special order item not carried in stock – non-returnable.



CODE	DIA/ SIZE (CM)	CASE PACK	CASE KG. (CUBE M³)
Rectangular – High Profile Shape			
915†	22 x 38	12	4,88 (0,011)
926*†	22,5 x 65 x 2,5	12	8,05 (0,022)
1014†	27 x 35	12	4,73 (0,012)
1015*Δ	26 x 38	24	12,91 (0,024)
1116*Δ	27,5 x 40,5	24	11,1 (0,03)
1216†	30,5 x 41,5	12	5,90 (0,017)
1313†	33 x 33	12	6,26 (0,012)
1318*†	32 x 45 x 3	12	8,85 (0,021)
1418†	35,5 x 45,7	12	7,81 (0,020)
1520†	38 x 51,5	12	9,63 (0,023)
1622†	40,5 x 56	12	12,95 (0,029)
16225*†	42 x 57	12	13,79 (0,031)
1826†	45,5 x 65,5	6	7,58 (0,026)
Rectangular – Low Profile Shape			
46†	11 x 15	12	0,84 (0,002)
57*†	12,5 x 18	12	1,05 (0,002)
810†	20,5 x 25	12	2,93 (0,006)
2025*†	53 x 65	6	9,70 (0,020)



Camtrays® Fiberglass Trays with Smooth Surface

SPECIFICATIONS

Material	Fiberglass Layers + Polyester Resin
Surface Characteristic	Smooth
Performance	Excellent
Stacking Lugs	Yes
Dishwasher Safe	Yes – Extensive
Chemical Resistance	Good
Drying Test	Excellent
Shock Resistance	Excellent
Break Resistance	Excellent
Scratch Resistance	Excellent
Stain Resistance	Excellent
Heat Resistance	-10° to +100°C‡

‡ Not for use in heated carts.

RECOMMENDED USE

High Traffic / Frequent Use
– Hospitals
– Schools
– Universities
– Canteens / Cafeterias / Self-Serve
– Military
– Hotel Room Service

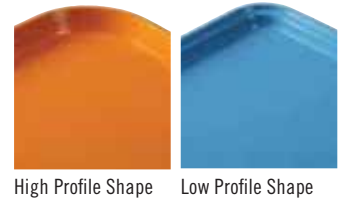

High Profile Shape Low Profile Shape

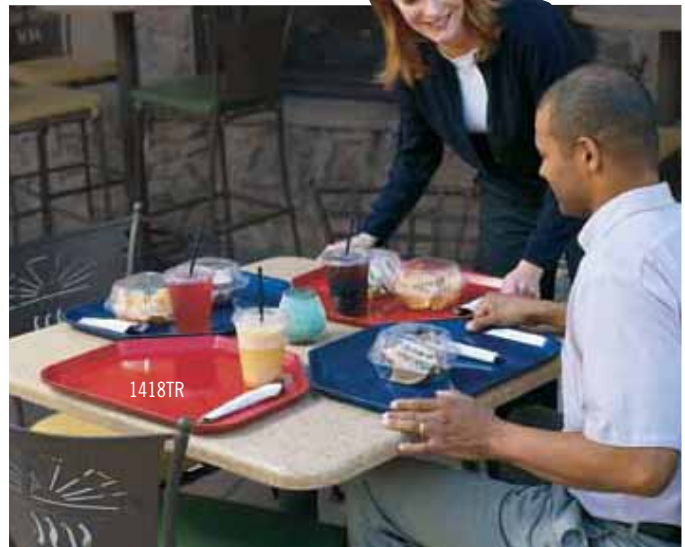
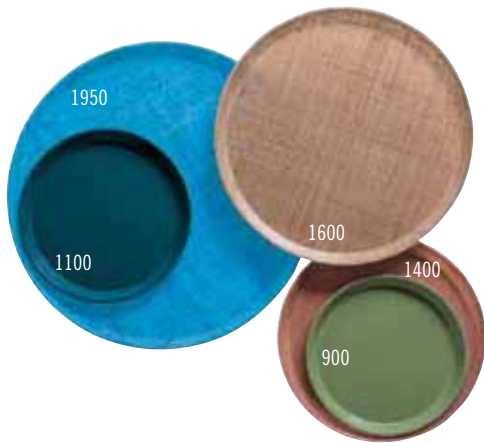

CODE	DIA/ SIZE (CM)	CASE PACK	CASE KG. (CUBE M ³)
Trapezoid – High Profile Shape			
1418TR*†	35,5 x 45,7	12	6,54 (0,018)
1422TR*†	35,5 x 56	12	7,78 (0,024)
Trapezoid – Low Profile Shape			
1121TR*†	28 x 53,3	12	7,14 (0,018)
1320TR*†	33 x 49,5	12	6,56 (0,020)
1520TR*†	37 x 49,5	12	7,44 (0,019)
Oval – Low Profile Shape			
2500*Δ	49 x 61	6	7,11 (0,025)
2700*Δ	56 x 68,5	6	8,5 (0,02)
Round – High Profile Shape			
900*Δ	∅ 23	12	2,01 (0,006)
1000*Δ	∅ 25,5	12	2,81 (0,007)
1100Δ	∅ 28	12	3,5 (0,01)
1200*Δ	∅ 30,5	12	3,74 (0,009)
1300*Δ	∅ 33	12	4,27 (0,013)
1400Δ	∅ 35,5	12	6,32 (0,014)
1600Δ	∅ 40,5	12	6,99 (0,021)
Round – Low Profile Shape			
1550*Δ	∅ 40,5	12	7,42 (0,02)
1950*Δ	∅ 49,5	12	11,46 (0,029)

† Available in Group I colors and patterns and Group III patterns.

Δ Available in Group I colors and patterns except Doily.

* Special order item not carried in stock – non-returnable.



Personalization, see page 14.

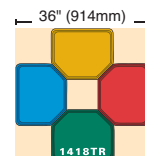
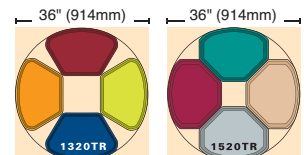
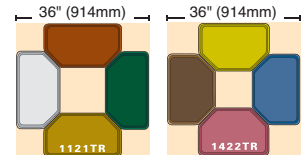

Camtrays® Fiberglass Trays with Smooth Surface

SPECIFICATIONS

Material	Fiberglass Layers + Polyester Resin
Surface Characteristic	Smooth
Performance	Excellent
Stacking Lugs	Yes
Dishwasher Safe	Yes – Extensive
Chemical Resistance	Good
Drying Test	Excellent
Shock Resistance	Excellent
Break Resistance	Excellent
Scratch Resistance	Excellent
Stain Resistance	Excellent
Heat Resistance	-10° to +100°C‡

* Special order item not carried in stock – non-returnable.

✦ Available in Group I colors and patterns and Group III Patterns.



‡ Not for use in heated carts. Personalization, see page 14.

RECOMMENDED USE

High Traffic / Frequent Use
– Hospitals
– Schools
– Universities
– Canteens / Cafeterias / Self-Serve
– Military
– Hotel Room Service

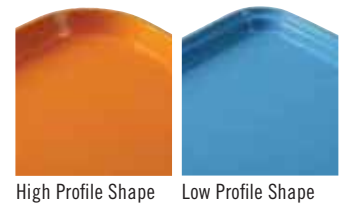

CODE	DIA/ SIZE (CM)	CASE PACK	CASE KG. (CUBE M³)
Metric Rectangular – High Profile Shape			
1313✦	33 x 33	12	6,26 (0,012)
3242✦	31,9 x 41,9	12	3,27 (0,014)
3853*✦	37,5 x 53	12	10 (0,023)
Metric Rectangular – Low Profile Shape			
2632*✦	26,5 x 32,5	12	4,5 (0,01)
3046*✦	30 x 46	12	7,94 (0,016)
3253*✦	32,5 x 53	12	7,73 (0,019)
3343✦	33 x 43	12	7,04 (0,014)
3753*✦	37 x 53	12	10,41 (0,024)



Camtray® Group I Colors

Colors listed alphabetically. See numerical reference on following page.



NR Trays are non-returnable.

CUSTOM COLOR MATCHING

Cambro offers custom color matching on Camtrays only (minimum order quantity of 144 each per size). Upon receipt of a firm purchase order, we will request a swatch of the color you want and our expert mixologists will match it. A finished tray sample will be submitted for the customer's approval. Requests for more than one sample and samples not accompanied by a firm purchase order will be charged. Custom color trays are non-returnable.

**Due to the catalog printing process, the colors & patterns shown may not be exact.
Contact Cambro or a Cambro representative for a color chip.**

Camtray® Group I Patterns

Galaxy

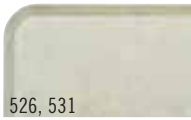

526, 531
Antique Parchment
(526 Gold), (531 Silver)

Swirl



270
Black & Gold



277
Grey

Doily



241
Antique Parchment

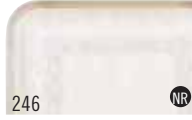

246
Light Peach

Decorator



203
Grass Mat

Abstract



214
Tan



215
Grey

NR Trays are non-returnable.



Camtray Group III - Wood

Wood



308
Burma Teak



304
Country Oak



301
Dark Basketweave



309
Java Teak

Linen



329
Toffee



302
Light Basketweave



303
Light Butcher Block



307
Light Elm



204
Rattan

Camtray Group I Colors – Numerical Reference by Color Code

Antique Parchment (101),
Desert Tan (104), Horizon Blue (105),
Light Peach (106), Pearl Grey (107),
Black (110), Lime-ade (113),
Brazil Brown (116), Dark Peach (117),
Sherwood Green (119),
Amazon Blue (123), White (148),

Tuscan Gold (171), Sky Blue (177),
Taupe (199), Citrus Orange (220),
Ever Red (221) Orange Pizazz (222),
Slate Blue (401), Blush (409),
Raspberry Cream (410),
Teal (414), Olive Green (428),
Key Lime (429), Real Rust (501),

Mustard (504), Cherry Red (505),
Suede Brown (508), Signal Red (510),
Bayleaf Brown (513),
Earthen Gold (514),
Robin Egg Blue (518),
Cambro Red (521),
Burgundy Wine (522),

Lemon Chiffon (536),
Cameo Yellow (537),
Cottage White (538), Grape (551).

**Due to the catalog printing process, the colors & patterns shown may not be exact.
Contact Cambro or a Cambro representative for a color chip.**

Non-Skid Versa Camtrays®

SPECIFICATIONS

Material	Fiberglass Layers + Polyester Resin + Non-Slip Surface
Surface Characteristic	Non-Slip
Performance	Excellent
Stacking Lugs	Yes
Dishwasher Safe	Yes - Extensive
Chemical Resistance	Good
Drying Test	Excellent
Shock Resistance	Excellent
Break Resistance	Excellent
Scratch Resistance	Good
Stain Resistance	Good
Heat Resistance	-40° to +80°C‡



‡ Not recommended for heated carts.

Personalization: Contact your Cambro representative for pricing.

RECOMMENDED USE

Moderate Traffic / Economic Priority

- Schools
- Universities
- Canteens / Cafeterias / Self-Serve
- Military
- Hotel Room Service



High Profile Shape Low Profile Shape



Low Design Profile Shape



CODE	DIA/ SIZE (CM)	CASE KG. (CUBE M³)
Non-Skid Versa Camtray – High Profile Shape		
1418VC	36,0 x 46,0	9,43 (0,02)
1520VC	38,0 x 51,0	11,84 (0,017)
1622VC*	41,0 x 56,0	14,1 (0,03)

Case Pack: 12

*Not available in Black with Pebbled Black (382).



Non-skid trays grip firmly.

CODE	DIA/ SIZE (CM)	CASE KG. (CUBE M³)
Non-Skid Versa Dietary Tray – Low Profile Shape		
1418VDC	36,0 x 46,0	9,3 (0,02)
1520VDC	38,0 x 51,0	12,23 (0,02)

Case Pack: 12



CODE	DIA/ SIZE (CM)	CASE KG. (CUBE M³)
Non-Skid Versa Century Camtray – Low Design Profile Shape		
1418VCC	36,0 x 46,0	9,27 (0,01)
1520VCC	38,0 x 51,0	11,96 (0,02)

Case Pack: 12



CODE	DIA/ SIZE (CM)	CASE KG. (CUBE M³)
Room Service Non-Skid Camtray – Low Profile Shape		
1520VCRST	38,0 x 51,0	12,7(0,03)

Case Pack: 12



Tray Colors:



380

Ivory with Sahara



381

Pearl Gray with Titan



382

Black with Pebbled Black

Dietary Trays

SPECIFICATIONS

Material	Fiberglass Layers + Polyester Resin
Surface Characteristic	Smooth
Performance	Excellent
Stacking Lugs	Yes
Dishwasher Safe	Yes – Extensive
Chemical Resistance	Good
Drying Test	Excellent
Shock Resistance	Excellent
Break Resistance	Good
Scratch Resistance	Good
Stain Resistance	Excellent
Heat Resistance	-10° to +100°C‡

‡ Not for use in heated carts..

RECOMMENDED USE

High Traffic / Frequent Use
– Hospitals
– Schools
– Universities
– Canteens / Cafeterias / Self-Serve
– Military
– Hotel Room Service

Available in Group I colors and patterns and Group III Patterns.

Dietary Trays are guaranteed for one year against breakage.

* Special order item not carried in stock – non-returnable.



Camlite® Trays

SPECIFICATIONS

Material	Fiberglass Layers + Polyester Resin
Surface Characteristic	Smooth
Performance	Excellent
Stacking Lugs	Yes
Dishwasher Safe	Yes – Extensive
Chemical Resistance	Good
Drying Test	Excellent
Shock Resistance	Excellent
Break Resistance	Good
Scratch Resistance	Good
Stain Resistance	Excellent
Heat Resistance	-10° to +100°C‡

‡ Not for use in heated carts.

RECOMMENDED USE

High Traffic / Frequent Use
– Hospitals
– Schools
– Universities
– Canteens / Cafeterias / Self-Serve
– Military
– Hotel Room Service

Colors: Rose Red (163), Yellow (145), Green (162), Blue (142), Tan (161), Steel White (676), Steel Red (675), Steel Blue (674), Black (110).

12 dozen minimum order required for any special color orders.



Low Profile Shape

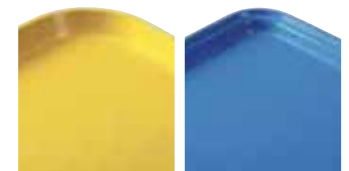

High Profile Shape Low Profile Shape



CODE	DIA/ SIZE (CM)	CASE PACK	CASE KG. (CUBE M³)
Dietary Trays – Low Profile Shape			
1216D*	30,5 x 41,5	12	6,70 (0,013)
1219D*	30,5 x 48,3	12	7,90 (0,018)
1220D*	30,5 x 51	12	7,46 (0,018)
1222D*	30,5 x 56	12	9 (0,018)
1418D*	35,5 x 46	12	7,51 (0,018)
1520D*	38,0 x 51,3	12	4,88 (0,02)
1622D*	40,3 x 55,6	12	11,8 (0,03)

CODE	DIA/ SIZE (CM)	CASE PACK	CASE KG. (CUBE M³)
Rectangular Camlite Trays – High Profile Shape			
1014CL	27 x 35	12	5,06 (0,011)
1216CL	30,5 x 41,5	12	5,64 (0,016)
1418CL	36 x 46	12	7,98 (0,019)
1520CL	38 x 51,5	12	9,65 (0,023)
1826CL	45,5 x 65,5	12	14,54 (0,038)
Rectangular Camlite Trays – Low Profile Shape			
3253CL	32,5 x 53	12	9,30 (0,019)
3753CL	37 x 53	12	8,62 (0,02)

Camtread® Fiberglass Trays with Non-Slip Rubber Surface

SPECIFICATIONS

Material	Fiberglass Layers + Polyester Resin + Non-Slip Rubber Surface Molded From Edge-To-Edge
Surface Characteristic	Non-Slip Rubber
Performance	Excellent
Stacking Lugs	Yes
Dishwasher Safe	Yes – Extensive
Chemical Resistance	Good
Drying Test	Excellent
Shock Resistance	Excellent
Break Resistance	Good
Scratch Resistance	Excellent
Stain Resistance	Good
Heat Resistance	-10° to +100°C‡

‡ Not for use in heated carts.

RECOMMENDED USE

High Traffic / Frequent Use
– Banquet Service
– Restaurants / Cafes
– Bars / Clubs / Pubs
– Catering
– Brasseries



High Profile Shape Low Profile Shape



Low Profile Shape Oval



CODE	DIA/ SIZE (CM)	CASE PACK	CASE KG. (CUBE M³)
Round – High Profile Shape			
900CT*	∅ 23	12	2,63 (0,006)
1100CT	∅ 28	12	4,06 (0,009)
1400CT	∅ 35,5	12	6,35 (0,015)
1600CT	∅ 40,5	12	11,68 (0,02)
1800CT	∅ 45	6	5,72 (0,0148)
Round – Low Profile Shape			
1550CT*	∅ 40,5	12	8,84 (0,02)
1950CT*	∅ 49,5	12	13,68 (0,030)
Oval – Low Profile Shap			
2500CT	49 x 59	6	8,51 (0,024)
2700CT	56 x 68,5	6	11,11 (0,038)
2900CT	73,5 x 60	6	12,23 (0,026)
Rectangular – High Profile Shape			
1014CT*	27 x 35	12	6,24 (0,012)
1216CT*	30,5 x 41,5	12	8,06 (0,017)
1418CT	36 x 46	12	9,98 (0,019)
1520CT*	38 x 51,5	12	13,58 (0,023)
1622CT	40,5 x 56	12	17,90 (0,029)
1826CT	45 x 65	6	10,58 (0,026)
Rectangular – Low Profile Shape			
3253CT	32,5 x 53	12	12,29 (0,021)

Orders for non-standard Camtread Tray colors will be handled by special quotation only.

* Special order item not carried in stock – non-returnable.

Do not use Camtread Trays in enclosed heated carts.



Personalization, see page 15.



PRORATED



FIVE YEAR PRORATED GUARANTEE AGAINST DELAMINATION.

Tray Colors:



Beechwood Trays with Smooth Surface

SPECIFICATIONS

Material	Beechwood Veneer
Surface Characteristic	Smooth
Performance	Good
Stacking Lugs	No
Dishwasher Safe	Yes – Normal
Chemical Resistance	Good
Drying Test	Good
Shock Resistance	Good
Break Resistance	Good
Scratch Resistance	Good
Stain Resistance	Good
Heat Resistance	-10° to +100°C‡



‡ Not for use in heated carts.

Beechwood Trays with Non-Slip Surface

SPECIFICATIONS

Material	Beechwood Veneer
Surface Characteristic	Non-Slip Surface
Performance	Good
Stacking Lugs	No
Dishwasher Safe	Yes – Minimal
Chemical Resistance	Good
Drying Test	Good
Shock Resistance	Good
Break Resistance	Good
Scratch Resistance	Good
Stain Resistance	Good
Heat Resistance	-10° to +100°C‡



‡ Not for use in heated carts.



RECOMMENDED USE

Mild Use / Emphasis on style with limited washing

- Banquet Service
- Restaurants / Cafes
- Catering



Tray Color:



000
Beechwood

RECOMMENDED USE

Mild Use / Emphasis on style with limited washing

- Banquet Service
- Restaurants / Cafes
- Bars / Clubs / Pubs
- Catering
- Brasseries



Tray Color:



000
Beechwood

CODE	DIA/ SIZE (CM)	CASE PACK	CASE KG. (CUBE M ³)
Rectangular – 60 Series			
PH556010	45,0 x 32,0	12	7,7 (0,015)
PH556020	58,0 x 38,0	12	12,5 (0,021)
PH556030	63,0 x 40,0	12	14,0 (0,029)
PH556040	70,0 x 45,0	12	19,0 (0,047)
PH556050	75,0 x 48,0	12	22,5 (0,047)
Rectangular – 65 Series			
PH556510	27,0 x 20,0	12	2,5 (0,004)
PH556520	33,0 x 23,0	12	3,4 (0,006)
Oval			
PH557010	23,0 x 16,0	24	1,2 (0,002)
PH557020	26,0 x 20,0	24	1,9 (0,003)
PH557030	29,0 x 21,0	24	1,8 (0,008)
PH557040	33,0 x 24,0	24	2,5 (0,005)
Round Beer Tray			
PH558510	∅ 32,0	12	5,8 (0,020)
PH558520	∅ 36,0	12	7,1 (0,023)
PH558530	∅ 42,0	12	9,0 (0,026)

CODE	DIA/ SIZE (CM)	CASE PACK	CASE KG. (CUBE M ³)
Rectangular – 60 Series			
PH556016	45,0 x 32,0	12	7,7 (0,015)
PH556026	58,0 x 38,0	12	12,5 (0,021)
PH556036	63,0 x 40,0	12	14,0 (0,029)
PH556046	70,0 x 45,0	12	19,0 (0,047)
PH556056	75,0 x 48,0	12	22,5 (0,047)
Rectangular – 65 Series			
PH556516	27,0 x 20,0	12	2,5 (0,004)
PH556526	33,0 x 23,0	12	3,4 (0,006)
Oval			
PH557016	23,0 x 16,0	24	1,2 (0,002)
PH557026	26,0 x 20,0	24	1,9 (0,003)
PH557036	29,0 x 21,0	24	1,8 (0,008)
PH557046	33,0 x 24,0	24	2,5 (0,005)
Round Beer Tray			
PH558516	∅ 32,0	12	5,8 (0,020)
PH558526	∅ 36,0	12	7,1 (0,023)
PH558536	∅ 42,0	12	9,0 (0,026)

Mahogany Wood Trays with Non-Slip Surface

SPECIFICATIONS

Material	Mahogany Veneer
Surface Characteristic	Non-Slip Surface
Performance	Good
Stacking Lugs	No
Dishwasher Safe	Yes – Minimal
Chemical Resistance	Good
Drying Test	Good
Shock Resistance	Good
Break Resistance	Good
Scratch Resistance	Good
Stain Resistance	Good
Heat Resistance	-10° to +100°C‡



‡ Not for use in heated carts.

RECOMMENDED USE

Mild Use / Emphasis on style with limited washing

- Banquet Service
- Restaurants / Cafes
- Bars / Clubs / Pubs
- Catering
- Brasseries

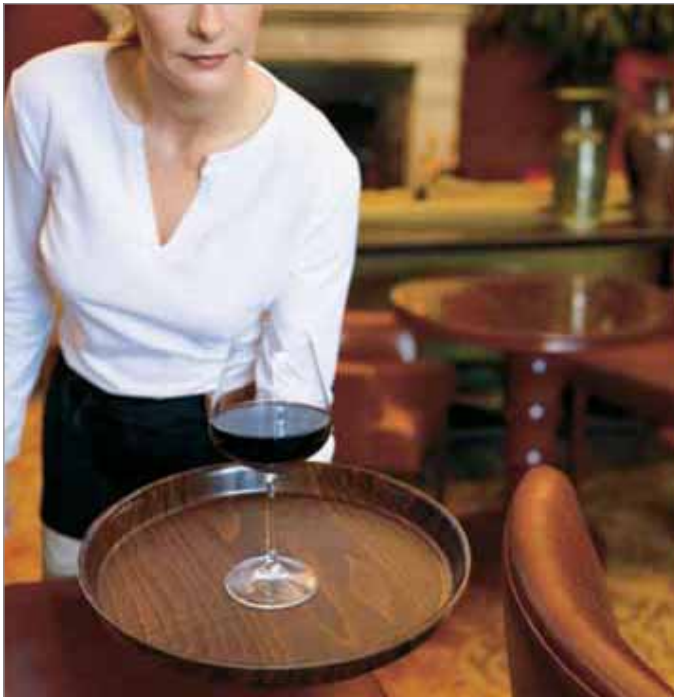

MW3858

MW3200



MW2129

CODE	DIA/ SIZE (CM)	CASE PACK	CASE KG. (CUBE M ³)
Rectangular			
MW3245	32,0 x 45,0	12	7,7 (0,015)
MW3858	37,5 x 57,5	12	12,5 (0,021)
MW3646	36,0 x 46,0	12	8,8 (0,012)
Oval			
MW2129	21,0 x 29,0	12	1,8 (0,004)
Round Beer Tray			
MW3200	ø 32,0	12	5,8 (0,020)
MW3600	ø 36,0	12	7,1 (0,023)
MW4200	ø 42,0	12	9,0 (0,026)

Tray Color:



W02
Mahogany

Corfu – Laminated Trays with Non-Slip Rubber Surface

SPECIFICATIONS

Material	Laminate + Non-Slip Rubber Surface
Surface Characteristic	Non-Slip Rubber Surface
Performance	Excellent
Stacking Lugs	No
Dishwasher Safe	Yes – Normal
Chemical Resistance	Excellent
Drying Test	Good
Shock Resistance	Good
Break Resistance	Good
Scratch Resistance	Good
Stain Resistance	Good
Heat Resistance	-10° to +100°C‡



Personalization,
see page 15.

‡ Not for use in heated carts.

Note: All laminated trays must be dried before stacking.

RECOMMENDED USE

Normal Use / Emphasis on style with limited washing

- Canteens / Cafeterias / Self-Serve
- Banquet Service
- Restaurants / Cafes
- Bars / Clubs / Pubs
- Catering



CODE	DIA/ SIZE (CM)	CASE PACK	CASE KG. (CUBE M³)
Rectangular			
C02632	26,5 x 32,5	12	5,4 (0,007)
C03253	32,5 x 53,0	12	10,2 (0,014)
C03343	33,0 x 43,0	12	8,23 (0,01)
C03646	36,0 x 46,0	12	10,0 (0,013)
C03753	37,0 x 53,0	12	11,7 (0,02)
Round			
C03200	∅ 32,0	12	4,3 (0,009)
C03800	∅ 38,0	12	6,3 (0,012)
C04300	∅ 43,0	12	8,6 (0,016)



Tray Colors:



D01
Black on Grey



D02
Brown

Capri – Laminated Trays with Smooth Surface

SPECIFICATIONS

Material	Laminate
Surface Characteristic	Smooth
Performance	Good
Stacking Lugs	No
Dishwasher Safe	Yes – Normal
Chemical Resistance	Excellent
Drying Test	Good
Shock Resistance	Good
Break Resistance	Good
Scratch Resistance	Good
Stain Resistance	Excellent
Heat Resistance	-10° to +100°C‡



‡ Not for use in heated carts.

Note: All laminated trays must be dried before stacking.

RECOMMENDED USE

Moderate Traffic / Economic Priority

- Canteens / Cafeterias / Self-Serve
- Hotel Room Service
- Restaurants / Cafes
- Bars / Clubs / Pubs
- Catering
- Brasseries



Capri – Rectangular with Handles



1525RST Tray Colors:



*Available in 1525RST only.

CODE	OUTER DIMENSIONS	INNER DIMENSIONS	CASE KG. (CUBE M ³)
Rectangular with Handles			
1525RST	39,22 x 63,5 x 3 cm	35,6 x 53,3 cm	13,2 (0,02)
Case Pack: 12			



Capri – Oval



CODE	DIA / SIZE (CM)	CASE PACK	CASE KG. (CUBE M ³)
Oval			
CA1623	16,0 x 23,0	24	1,4 (0,004)
CA2026	20,0 x 26,5	24	2,7 (0,005)
CA2129	21,0 x 29,0	24	3,4 (0,006)

Capri – Laminated Trays with Smooth Surface

CODE	SIZE (CM)	CASE PACK	CASE KG. (CUBE M ³)
Rectangular			
CA2028	20,0 x 28,0	24	3,8 (0,005)
CA2632	26,5 x 32,5	24	7,0 (0,009)
CA2738	27,0 x 38,0	24	8,5 (0,011)
CA2836	28,0 x 36,0	24	8,5 (0,011)
CA3244	32,0 x 44,0	24	12,7 (0,016)
CA3253	32,5 x 53,0	24	15,0 (0,021)
CA3343	33,0 x 43,0	24	13,5 (0,019)
CA3446	34,0 x 46,0	24	15,9 (0,02)
CA3646	36,0 x 46,0	24	15,0 (0,022)
CA3748	37,0 x 48,0	24	17,0 (0,023)
CA3753	37,0 x 53,0	24 </td <td>18,0 (0,026)</td>	18,0 (0,026)
CA3952	39,0 x 52,0	24	18,5 (0,025)
CA4361	43,0 x 61,0	12	14,6 (0,019)

Capri – Rectangular



CODE	DIA / SIZE (CM)	CASE PACK	CASE KG. (CUBE M ³)
Round			
CA1300	∅ 13,0	24	1,5 (0,002)
CA3200	∅ 32,0	24	6,5 (0,013)
CA3800	∅ 38,0	24	9,4 (0,018)
CA4300	∅ 43,0	24	13,0 (0,022)

Capri – Round



Tray Pattern:

Thank You (E01)
Available in CA1300 only.



CODE	DIA / SIZE (CM)	CASE PACK	CASE KG. (CUBE M ³)
Trapezoid			
CA3247TR	32,0 x 47,0	24	11,7 (0,023)

Capri – Trapezoid



Tray Colors:



E73

Mahogany



E75

Birch



E76

Walnut



E77

Teak



E78

White



E79

Black

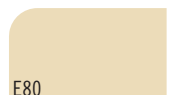

E80

Beige



E81

Grey



E82

Charcoal Granite

Mykonos – Laminated Trays with Non-Slip Surface

SPECIFICATIONS

Material	Laminate + Non-Slip Surface
Surface Characteristics	Non-Slip Surface
Performance	Good
Stacking Lugs	No
Dishwasher Safe	Yes – Minimal
Chemical Resistance	Good
Drying Test	Good
Shock Resistance	Good
Break Resistance	Good
Scratch Resistance	Good
Stain Resistance	Good*
Heat Resistance	-10° to +100°C‡

RECOMMENDED USE

Moderate Use / Emphasis on Style with Limited Washing

- Banquet Services
- Restaurants / Cafes
- Bars / Clubs / Pubs
- Catering

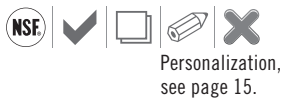

‡ Not for use in heated carts.

Note: All laminated trays must be dried before stacking.

*Limited stain resistance for Birch (E75)



Tray Colors:

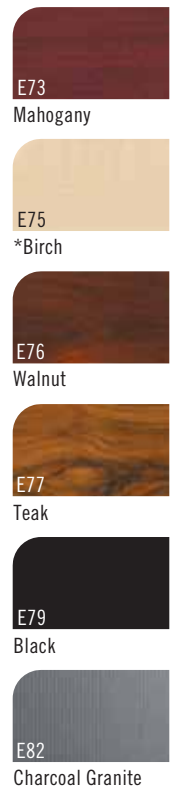

CODE	DIA/ SIZE (CM)	CASE PACK	CASE KG. (CUBE M ³)
Rectangular			
MY2632	26,5 x 32,5	24	8,0 (0,009)
MY2738	27,0 x 38,0	24	8,5 (0,011)
MY3244	32,0 x 44,0	24	13,9 (0,016)
MY3253	32,5 x 53,0	24	15,3 (0,021)
MY3343	33,0 x 43,0	24	13,5 (0,019)
MY3446	34,0 x 46,0	24	16,5 (0,02)
MY3646	36,0 x 46,0	24	15,3 (0,022)
MY3753	37,0 x 53,0	24	18,3 (0,023)
MY3952	39,0 x 52,0	24	18,7 (0,023)
MY4361	43,0 x 61,0	12	14,6 (0,019)
Oval			
MY2026	20,0 x 26,5	24	2,9 (0,005)
MY2129	21,0 x 29,0	24	3,7 (0,006)
Round			
MY3200	ø 32,0	24	6,8 (0,012)
MY3800	ø 38,0	24	9,6 (0,018)
MY4300	ø 43,0	24	13,0 (0,022)

Madeira – Laminated Trays with Textured Wood Surface

SPECIFICATIONS

Material	Laminate
Surface Characteristics	Textured – Top and Bottom
Performance	Good
Stacking Lugs	No
Dishwasher Safe	Yes – Normal
Chemical Resistance	Excellent
Drying Test	Good
Shock Resistance	Good
Break Resistance	Good
Scratch Resistance	Good
Stain Resistance	Excellent
Heat Resistance	-10° to +100°C‡



Personalization, see page 15.

‡ Not for use in heated carts.

Note: All laminated trays must be dried before stacking.

RECOMMENDED USE

Moderate Traffic / Economic Priority

- Canteens / Cafeterias / Self-Serve
- Hotel Room Service
- Restaurants / Cafes
- Bars / Clubs / Pubs



MA3646

MA2435

MA3652TR

MA3142H

MA4300

MA3800

MA3200

Tray Colors:

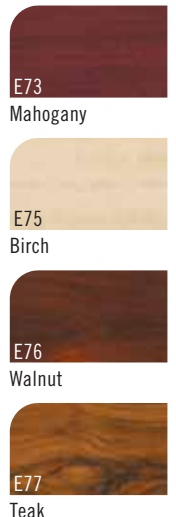

CODE	DIA/ SIZE (CM)	CASE PACK	CASE KG. (CUBE M ³)
Rectangular			
MA2435	24,0 x 35,0	24	6,9 (0,009)
MA3343	33,0 x 43,0	24	13,5 (0,019)
MA3646	36,0 x 46,0	24	15,0 (0,022)
MA4361	43,0 x 61,0	12	14,6 (0,019)
Rectangular with handle			
MA3142H	31,0 x 42,0	24	9,4 (0,019)
Trapezoid			
MA3652TR	36,0 x 52,0	24	14,4 (0,026)
Round			
MA3200	ø 32,0	24	6,5 (0,013)
MA3800	ø 38,0	24	9,4 (0,018)
MA4300	ø 43,0	24	13,0 (0,022)

Fast Food Trays

SPECIFICATIONS

Material	Polypropylene
Surface Characteristic	Textured
Performance	Good
Stacking Lugs	Yes
Dishwasher Safe	Yes-Minimal**
Chemical Resistance	Excellent
Drying Test	Good
Shock Resistance	Good
Break Resistance	Good
Scratch Resistance	Good
Stain Resistance	Good
Heat Resistance	-10° to +80°C‡

‡ Not for use in heated carts.

** Wash once per day for 60 seconds at a maximum temperature of 80°C.

RECOMMENDED USE

Moderate Traffic / Economic Priority

- Quick Serve Restaurants
- Food Courts / Snack Shops



High Profile Shape

High Profile Shape with handles



1418FF

1216FF



1217FFH

Available Colors:



CODE	DIA/ SIZE (CM)	CASE PACK	CASE KG. (CUBE M ³)
Rectangular – High Profile Shape			
1014FF	26,5 x 34,5	24	5,90 (0,017)
1216FF	30 x 41	24	8,55 (0,029)
1418FF	36 x 46	12	6 (0,017)
Rectangular – High Profile Shape with Handles			
1217FFH*	30 x 43	24	9,96 (0,026)

* Available in the following colors: Black (110), Sherwood Green (119), Orange (166), Brown (167), Cranberry (416).

* Personalization not available. Product non-returnable.



Personalization, see page 15.

Polytread® Trays

SPECIFICATIONS

Material	Polypropylene + Non-Slip Rubber Surface
Surface Characteristic	Non-Slip Rubber Surface
Performance	Good
Stacking Lugs	Yes
Dishwasher Safe	Yes – Minimal
Chemical Resistance	Good
Drying Test	Good
Shock Resistance	Good
Break Resistance	Good
Scratch Resistance	Good
Stain Resistance	Good
Heat Resistance	-10° to +80°C‡



‡ Not for use in heated carts.

RECOMMENDED USE

Moderate Traffic / Economic Priority

- Hotel Room Service
- Restaurants / Cafes
- Bars / Clubs / Pubs



High Profile Shape



Tray Colors:

110
Black

167
Brown

CODE	DIA/ SIZE (CM)	CASE PACK	CASE KG. (CUBE M³)
Round – High Profile Shape			
PT1100	ø 28	12	3,3 (0,009)
PT1400	ø 35,5	12	4,58 (0,014)
PT1600	ø 40,5	12	5,84 (0,019)
Rectangular – High Profile Shape			
PT1014	27 x 34,5	24	10 (0,02)
PT1216	30 x 41,5	24	11,8 (0,032)
PT1418	36 x 46	12	8,3 (0,02)

Polycarbonate Camwear® Trays

SPECIFICATIONS

Material	Polycarbonate
Surface Characteristic	Textured
Performance	Excellent
Stacking Lugs	Yes
Dishwasher Safe	Yes – Extensive
Chemical Resistance	Good
Drying Test	Excellent
Shock Resistance	Excellent
Break Resistance	Excellent
Scratch Resistance	Very Good
Stain Resistance	Very Good
Heat Resistance	-40° to +99°C‡



‡ Not for use in heated carts.

RECOMMENDED USE

Moderate Traffic / Economic Priority

- Schools
- Universities
- Canteens / Cafeterias / Self-Serve
- Military
- Quick Serve Restaurants
- Food Courts / Snack Shops

Colors: Blue (168), Beige (133), White (148).



High Profile Shape

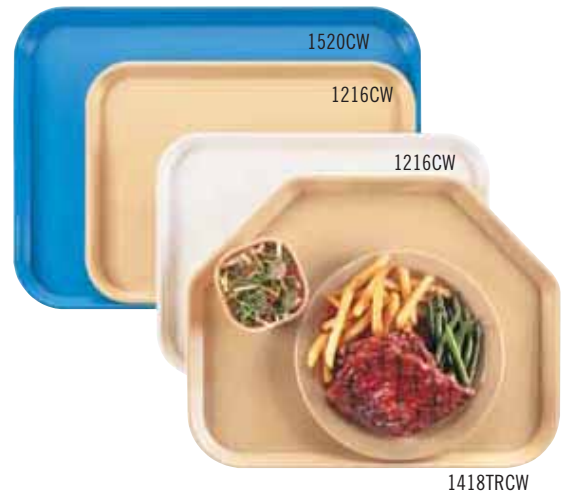

CODE	DIA/ SIZE (CM)	CASE PACK	CASE KG. (CUBE M³)
Rectangular – High Profile Shape			
1418CW	35,5 x 46	12	7,90 (0,019)
1520CW	38 x 51	12	9,5 (0,024)
Trapezoid – High Profile Shape			
1418TRCW	35,5 x 46	12	7,3 (0,02)

Compartment Trays

SPECIFICATIONS

Name	Camwear Polycarbonate	Budget	Penny-Saver
Code	10146CW	BCT1014	PS1014
Material	Polycarbonate	ABS	Co-Polymer
Surface Characteristic	Textured	Textured	Textured
Performance	Excellent	Excellent	Excellent
Stacking Lugs	Yes	Yes	Yes
Dishwasher Safe	Yes – Extensive	Yes – Extensive	Yes – Minimal
Chemical Resistance	Good	Excellent	Excellent
Drying Test	Excellent	Excellent	Excellent
Shock Resistance	Excellent	Good	Good
Break Resistance	Excellent	Good	Excellent
Scratch Resistance	Very Good	Very Good	Very Good
Stain Resistance	Very Good	Very Good	Very Good
Heat Resistance	-40° to +99°C‡	-10° to +82°C‡	-10° to +80°C‡

‡ Not for use in heated carts.

RECOMMENDED USE

Moderate Traffic /
Economic Priority

- School
- Universities
- Military



Polycarbonate
Only

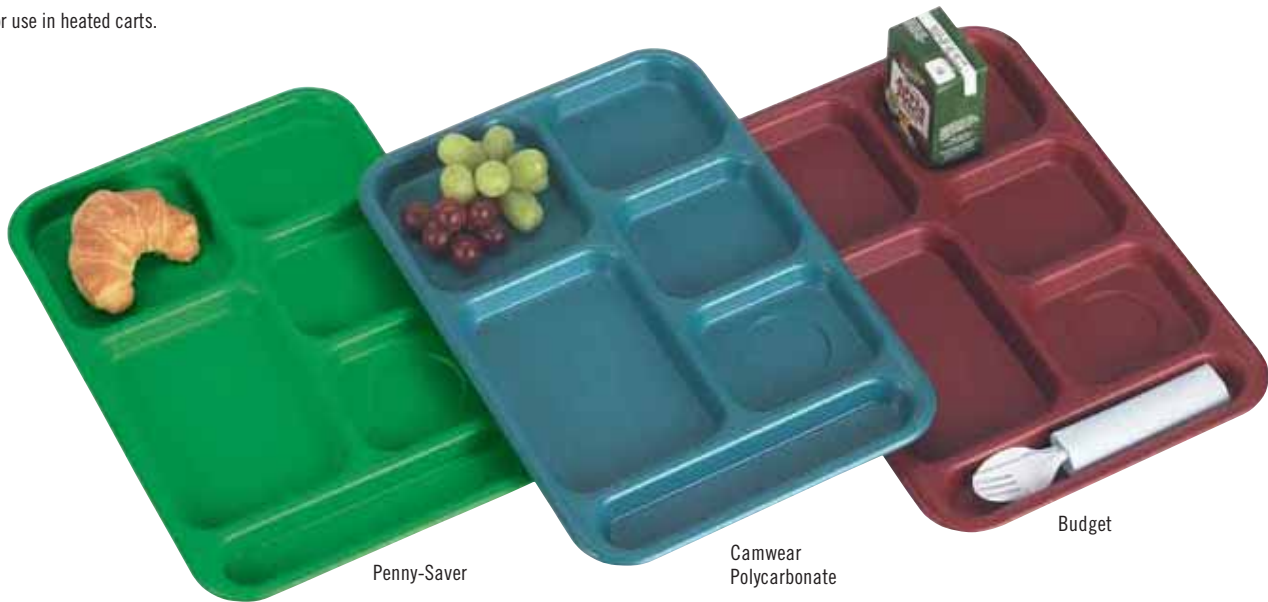

Penny-Saver

Camwear
Polycarbonate

Budget

Budget Colors



119
Sherwood Green



145
Yellow



161
Tan



163
Red



186
Navy Blue



414
Teal



416
Cranberry

Penny-Saver Colors



437
Grass Green



145
Yellow



161
Tan



186
Navy Blue



414
Teal



416
Cranberry

Camwear Colors



119
Sherwood Green



133
Beige



145
Yellow



186
Navy Blue



416
Cranberry

CODE	DIA/ SIZE (CM)	CASE PACK	CASE KG. (CUBE M ³)
Camwear Polycarbonate			
10146CW	25,4 x 36,5	24	9,76 (0,030)
Budget – ABS			
BCT1014	25,4 x 36,5	24	8,22 (0,028)
Penny-Saver – Co-Polymer			
PS1014	25,4 x 36,5	24	6,23 (0,023)

Compartment Trays

SPECIFICATIONS

Material	Polycarbonate	Co-Polymer
Surface Characteristic	Textured	Textured
Performance	Excellent	Excellent
Stacking Lugs	Yes	Yes
Dishwasher Safe	Yes – Extensive	Yes – Minimal
Chemical Resistance	Good	Excellent
Drying Test	Excellent	Excellent
Shock Resistance	Excellent	Good
Break Resistance	Excellent	Excellent
Scratch Resistance	Very Good	Very Good
Stain Resistance	Very Good	Very Good
Heat Resistance	-40° to +99°C‡	-10° to +80°C‡



‡ Not for use in heated carts.

915CW: 100CW, SRB13CW and 50CW bowls fit in round compartment. 10CW and 150CW bowls fit in square compartment. See Dinnerware and Swirl Bowl sections.

Co-Polymer trays are not NSF listed.

Polycarbonate compartment trays are guaranteed for two years against breakage.



915CW & 915CP
4 square food compartments
1 round food compartment
1 silverware compartment



915CW

1596W

1596CW



1596CW & 1596CP

5 square food compartments
1 silverware compartment



915CW & 915CP

RECOMMENDED USE

Moderate Traffic / Economic Priority

- School
- Universities
- Military

Polycarbonate



Co-Polymer

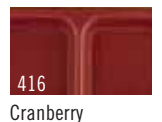
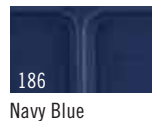

CODE	DIA/ SIZE (CM)	CASE PACK	CASE KG. (CUBE M ³)
Camwear Polycarbonate			
1596CW	22,9 x 38	24	9,36 (0,0167)
915CW	22,2 x 38	24	7,87 (0,027)
Co-Polymer			
1596CP	22,9 x 38	24	9,1 (0,0167)
915CP	22,2 x 38	24	5,51 (0,026)

Compartment Serving Trays & Trapezoid Compartment Trays

Compartment Serving Trays

- For cafeteria-style feeding in high security environments.
- Compartment configurations designed to meet all menu requirements.

Camwear Polycarbonate
6-Compartment
Colors: Navy (186), Cranberry (416), Yellow (145), Sherwood Green (119), Beige (133).

5-Compartment Colors: Beige (133).

Co-Polymer Colors:
 Brown (167), Tan (161).

Personalization not available.

Co-Polymer is not NSF Listed.



Trapezoid Compartment Trays

- Space saving tray for self serve correctional facility feeding.
- Offers seven deep compartments for ample, portion controlled servings.
- Serve soup and salad at the same time.

Camwear Colors: Beige (133).

Trapezoid Compartment Trays are covered by the following U.S. Patent D 508,634.



14105CW tray with 10CW bowl and 10CWL lid.

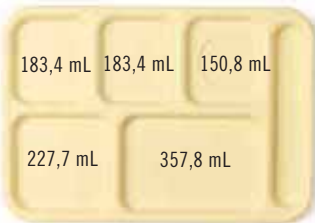

10146CW

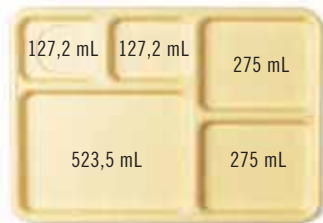

10145CW



14105CW

Also Available in 14105CP



14187TRCW



CODE	DESCRIPTION	DIMENSIONS L x W x D (CM)	CASE KG (CUBE M ³)
Camwear Polycarbonate			
10146CW	Compartments	25,4 x 36,8 x 2,4	9,34 (0,030)
14105CW	Compartments	27,2 x 35,2 x 2,9	8,98 (0,018)
10145CW	Compartments	25,4 x 36,8 x 2,4	9 (0,029)
Co-Polymer			
14105CP	Compartments	27,2 x 35,2 x 2,9	6,81 (0,019)

Case Pack: 24

www.cambro.com

CODE	DIMENSIONS L x W x D (CM)	CASE KG (CUBE M ³)
Camwear Polycarbonate		
14187TRCW	45,6 x 35,4 x 4,0	10,16 (0,038)
Case Pack: 12		

Meal Delivery Trays & Separator® Compartment Trays

Meal Delivery Trays

- Three deep-dish food compartments for large portions.
- Snap-on cover fits securely.
- Textured surface minimizes scratching.

Camwear Polycarbonate Colors:
Beige (133), Teal (414).
Lid Color: Clear (135).

Co-Polymer Colors:
Teal (414), Brown (167), Tan (161).
Lid Color: White (148).

Personalization not available.

Co-Polymer is not NSF Listed.

Not for use in heated carts.



Separator Compartment Trays

- Six compartment tray designed specifically for in-cell feeding programs.
- Serve both hot and cold food from the same tray.
- Tray with cover separates each compartment to retain food temperature and reduce spills.
- Locking ridges on top of cover and bottom of tray ensure more secure stacking.

Camwear Polycarbonate Color:
Beige (133).
Lid Color: Clear (135).

Co-Polymer Colors:
Teal (414), Brown (167), Tan (161).
Lid Color: Translucent (190).

Personalization not available.

Co-Polymer is not NSF Listed.

Not recommended for heated cart.

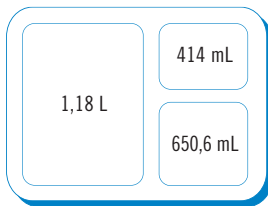

9113CW/9113CP

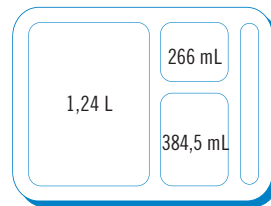

9114CW/9114CP



10146DCW/10146DCP



CODE	DESCRIPTION	DIMENSIONS L x W x D (CM)	CASE KG (CUBE M ³)
Camwear Polycarbonate			
9113CW	3 Compartments	23 x 28 x 6,5	10,5 (0,05)
9114CW	4 Compartments	23 x 28 x 6,5	11,8 (0,05)
911CWC	Lid fits both trays		5,78 (0,019)
Co-Polymer			
9113CP	3 Compartments	23 x 28 x 6,5	7,63 (0,044)
9114CP	4 Compartments	23 x 28 x 6,4	9,1 (0,05)
911CPC	Lid fits both trays		4,26 (0,019)

Case Pack: 24

CODE	DESCRIPTION	DIMENSIONS L x W x D (CM)	CASE KG (CUBE M ³)
Camwear Polycarbonate			
10146DCW	6 Compartments	25,4 x 36 x 2,9	11,1 (0,03)
10146DCWC	Lid fits 10146DCW		4,44 (0,034)
Co-Polymer			
10146DCP	6 Compartments	25,4 x 36 x 2,9	8,12 (0,044)
10146DCPC	Lid fits 10146DCP		6,7 (0,03)

Case Pack: 24

Tray on Tray Meal Delivery System

Combine pre-plated hot and cold food portions into a reusable, single service unit designed for in-cell feeding and cook-chill applications.

Base Tray

- Combine pre-plated hot and cold food portions into a reusable, single service unit.
- Works as a tray or for in-cell feeding with the insert tray.
- Base tray has 5 compartments with 1 compartment for resting the insert tray.

Camwear Polycarbonate Color:
Beige (133).

Co-Polymer Colors:
Brown (167), Tan (161).

Personalization not available.

1411CW is NSF Listed.

Co-Polymer is not NSF Listed.

Not for use in heated carts.



1411CW/1411CP



1411CW



1411CW base tray with 853FH insert tray

CODE	DESCRIPTION	DIMENSIONS L x W x D (CM)	CASE KG (CUBE M ³)
Camwear Polycarbonate			
1411CW	Compartments	36,5 x 26,8 x 3,3	11,6 (0,035)
Co-Polymer			
1411CP	Compartments	36,5 x 26,8 x 3,3	8,62 (0,034)

Case Pack: 24

Insert Tray

- Designed specifically for cook-chill applications as it can be covered with heat seal film or snap-on cover.
- Eight trays efficiently fit on a standard sheet pan or in an 45,5 x 65,5 cm wire rack.

Camwear Polycarbonate Color:
Beige (133).

Lid Color: Clear (135).

Co-Polymer Colors:
Brown (167), Tan (161).

Lid Color: Translucent (190).

**Heat Resistant Plastic
Tray and Lid Color:** Amber (150).

Personalization not available.

853FCW, 853FCWC, 853FH and 853FHC are NSF Listed.

Co-Polymer is not NSF Listed.

Not for use in heated carts.

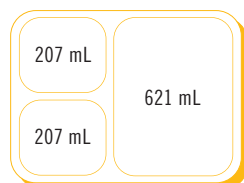

853FCW/853FCP/853FH



CODE	DESCRIPTION	DIMENSIONS L x W x D (CM)	CASE KG (CUBE M ³)
Camwear Polycarbonate			
853FCW	Compartments	22,1 x 16 x 4,8	5,20 (0,021)
853FCWC	Lid for 853FCW		2,83 (0,008)
Co-Polymer			
853FCP	Compartments	22,1 x 16 x 4,8	4,44 (0,022)
853FCPC	Lid for 853FCP		2,09 (0,008)
Heat Resistant Plastic			
853FH	Compartments	22,1 x 16 x 4,8	7,5 (0,0216)
853FHC	Lid for 853FH		2,99 (0,0128)

Case Pack: 24

Market Trays

SPECIFICATIONS

Material	Fiberglass Layers + Polyester Resin
Surface Characteristic	Smooth
Performance	Excellent
Stacking Lugs	Yes
Dishwasher Safe	Yes – Extensive
Chemical Resistance	Good
Drying Test	Excellent
Shock Resistance	Excellent
Break Resistance	Good
Scratch Resistance	Good
Stain Resistance	Excellent
Heat Resistance	-10° to +100°C‡

‡ Not for use in heated carts.

RECOMMENDED USE

Moderate Traffic /
Economic Priority

– Deli / Buffet Displays

Colors: Salmon (149), Yellow (145),
Blue (142), Green (140), White (148),
Black (110).

Colors NSF listed for food contact:
Black (110), White (148), Blue (142),
Green (140).

* Special order item not carried in stock
– non-returnable.

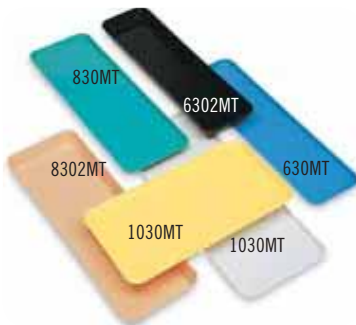

CODE	DIA/ SIZE (CM)	CASE PACK	CASE KG. (CUBE M³)
Market Trays			
630MT*	16,4 x 76,2 x 1,9	12	6,6 (0,016)
826MT*	21,6 x 64,1 x 1,9	12	7,87 (0,015)
830MT*	21,4 x 76,2 x 1,9	12	9,5 (0,02)
913MT*	22 x 31,6 x 2,1	12	9,5 (0,02)
918MT*	22 x 45,7 x 2,1	12	4,63 (0,011)
926MT*	22,5 x 64,9 x 2,5	12	7,45 (0,022)
1015MT*	25,7 x 38,1 x 1,9	24	6,24 (0,024)
1030MT*	26,5 x 76,2 x 1,9	12	11,4 (0,027)
1218MT*	29,2 x 45,1 x 2,5	12	7 (0,018)
1224MT*	31,6 x 61 x 1,9	12	9,70 (0,023)
1227MT*	31,6 x 68,6 x 1,9	12	11,6 (0,025)
1230MT*	31,6 x 76,2 x 1,9	12	11,91 (0,027)
1318MT*	32,1 x 45,1 x 2,7	12	8,85 (0,022)
1826MT*	45,2 x 65,2 x 2,7	6	7,52 (0,025)
2025MT*	52,7 x 64,9 x 2,1	6	9,5 (0,023)
Market Pans			
6302MT*	16,7 x 76,2 x 5,1	12	7,95 (0,02)
8262MT*	21,5 x 64,1 x 5,1	12	9,5 (0,026)
8302MT*	21,4 x 76,2 x 5,1	12	10,75 (0,026)
92615MT*	22,5 x 64,8 x 3,8	12	8,91 (0,021)
10302MT*	26,5 x 76,2 x 5,1	12	13 (0,032)

V-Series Tray

SPECIFICATIONS

Material	SMC – High Performance Fiberglass Reinforced Polyester
Surface Characteristic	Smooth
Performance	Excellent
Stacking Lugs	Yes
Dishwasher Safe	Yes – Extensive
Chemical Resistance	Excellent
Drying Test	Excellent
Shock Resistance	Excellent
Break Resistance	Excellent
Scratch Resistance	Excellent
Stain Resistance	Excellent
Heat Resistance	-40° to +130°C

‡ Not for use in heated carts.

RECOMMENDED USE

Moderate Traffic /
Economic Priority

- Hospitals
- Schools
- Universities
- Canteens / Cafeterias / Self-Serve
- Military

Color: Antique Parchment (101).



1000VT



CODE	DIA/SIZE (CM)	CASE PACK	CASE KG. (CUBE M³)
1000VT	Ø 25,4	12	3,47 (0,007)

ENG MET CS / Trays

Tablotherm Insulated Trays

SPECIFICATIONS

Material	Polypropylene + Foam Insulation
Characteristic	Insulated Tray
Performance	Excellent
Heat Retention	64°C for Approximately 120 Minutes
Dishwasher Safe	Yes
Stackable	Yes
Minimum Food Temperature before Plating	80°C to 90°C‡
Individual Dish Cover	Yes – Prevent Spilling of Soup and Sauces



‡ Not for use in heated carts.

RECOMMENDED USE

Moderate Use

- Hospital Meal Delivery / Nursing Homes
- Hotel Room Service
- Catering
- Home Meal Delivery

Pellet system allows to retain serving temperature of 64.1°C for 2 hours. Actual test done on ITPD3753 and ITPD3253 with hot water.

ITPD3253 Test

	Without Pellet	With Pellet
1 min.	85°C	85°C
20 min.	72,8°C	80,9°C
40 min.	68,3°C	77,4°C
60 min.	64,8°C	74,2°C
80 min.	61,8°C	71,1°C
100 min.	59,1°C	68,1°C
120 min.	56,6°C	65,4°C

ITPD3753 Test

	Without Pellet	With Pellet
1 min.	85°C	85°C
20 min.	69,8°C	80,2°C
40 min.	64,9°C	76,6°C
60 min.	61,2°C	73,1°C
80 min.	58,0°C	70,0°C
100 min.	55,3°C	66,9°C
120 min.	52,8°C	64,1°C



ITPD3253 - Gastronorm size

ITPD3753 - Euronorm size



Light gray polypropylene lid with integrated rubber seal. Lid cannot be used in microwave oven.

For a complete guide to maximizing heat retention, contact your Cambro representative.

CODE	DESCRIPTION	DIMENSIONS W x L x H (CM)	CASE KG (CUBE M ³)
Tablotherm – Insulated Tray with Porcelain Dishes, seal covers and pellet			
ITPD3753	Euronorm insulated tray including: 1 ea. two-compartment menu plate - 122 400 050 and 1 ea. cover 122 600 050 and 1 ea. pellet 165PW 3 ea. multiple-use bowl - 122 500 050 and 3 ea. cover 122 700 050.	37,0 x 53,0 x 10,5	5,4 (0,024)
ITPD3253	Gastronorm insulated tray including: 1 ea. two-compartment menu plate - 122 400 050 and 1 ea. cover 122 600 050 and 1 ea. pellet 165PW 2 ea. multiple-use bowl - 122 500 050 and 2 ea. cover 122 700 050.	32,5 x 48,0 x 10,5	4,2 (0,019)
Tablotherm – Insulated Tray without porcelain dishes, seal covers and pellet			
IT3753	Euronorm insulated tray – Empty	37,0 x 53,0 x 10,5	3,1 (0,024)
IT3253	Gastronorm insulated tray – Empty	32,5 x 48,0 x 10,5	2,4 (0,019)

Porcelain dishes

122 400 050 Two compartment menu plate. Outside ø 254 mm. Capacity 750 ml. White.

122 500 050 Multiple-use bowl. Outside ø 120 mm. Capacity 400 ml. White.

Food covers, light gray, polypropylene with integrated rubber seal

122 600 050 For two compartment menu plate

122 700 050 For multiple-use bowl

Pellet System

165PW SMC pellet ø 16,5 cm

Menu card

112 430 000 Yellow 100 x 70 mm

ITPD3753, IT3753 Color: Two Tone Green.

ITPD3253, IT3253 Color: Two Tone Gray.

165PW Color: A42 165PW Case Pack: 1 Each.

TABLE SERVICE



Camwear® Polycarbonate Dinnerware

5 5 YEAR PRORATED
GUARANTEE AGAINST
BREAKAGE

- Virtually unbreakable Camwear polycarbonate resists stains, odors and scratches.
- Textured surface on salad and dinner plates for long wear.
- Ideal for schools, cafeterias, day care centers and healthcare facilities.



Oval Platters & Compartment Plates



CODE	90SPCW	120CWP	93CW	HK93BCW
DIAMETER	22,9 x (H) 4 cm	30,5 x 22,9 cm	22,9 cm	24,1 cm
DESCRIPTION	Round, Soup Bowl	Oval, Narrow Rim	Narrow Rim	Narrow Rim
CASE PACK	48	24	48	12
CASE KG (CUBE M ³)	7,51 (0,0187)	3,97 (0,011)	7,9 (0,0210)	4,5 (0,023)

*HK93BCW is available in Beige only (133)

Plates



CODE	10CWNR	9CWNR	825CWNR	725CWNR	65CWNR	55CWNR
DIAMETER	25,4 cm	22,9 cm	21 cm	18,4 cm	16,5 cm	14 cm
DESCRIPTION	Narrow Rim	Narrow Rim	Narrow Rim	Narrow Rim	Narrow Rim	Narrow Rim
CASE PACK	48	48	48	48	48	48
CASE KG (CUBE M ³)	10,4 (0,0219)	7,20 (0,017)	6,81 (0,014)	5,09 (0,011)	4,27 (0,010)	3,18 (0,007)

Bowls



Optional lid available

CODE	10CW	10CWL	35CW	45CW	50CW	60CW	100CW	150CW
APPROX. CAPACITY	278 mL	—	252 mL	150 mL	452 mL	322 mL	370 mL	494 mL
DESCRIPTION	Square Bowl	Lid for 10CW Bowl	Bouillon	Fruit Cup	Nappie Bowl	Grapefruit Bowl	Nappie Bowl	Square Bowl
CASE PACK	48	48	48	48	48	48	48	48
CASE KG (CUBE M ³)	2,85 (0,013)	1,21 (0,004)	2,40 (0,007)	2,7 (0,0093)	5,29 (0,017)	5,2 (0,0158)	3,4 (0,0170)	3,57 (0,017)
SHAPE	Square	Square	Round	Round	Round	Round	Round	Top/Round Bottom/Square
OUTSIDE DIAMETER	10,2 x 10,2 cm	—	9,8 cm	11,7 cm	13,3 cm	15,2 cm	12,5 cm	Top: 13,3 cm Bottom: 6,4 x 6,4 cm
HEIGHT	4,8 cm	—	5,4 cm	3,3 cm	5,4 cm	4 cm	24,3 cm	5,7 cm

Mug & Cup



CODE	75CW	96CW
APPROX. CAPACITY	239 mL	288 mL
DESCRIPTION	Stacking Cup	Mug
CASE PACK	48	48
CASE KG (CUBE M ³)	3,9 (0,0188)	4,71 (0,027)
MAX DIA./HEIGHT	10,3* cm / 8 cm	10,6* cm / 9,5 cm
FULL SIZE CAMRACK®	16C414	16C414

* Maximum diameter includes handles.

Heat Keepers



DESCRIPTION	3 COMPARTMENT BASE AND COVER	HEAT KEEPER BASE AND COVER FOR 22,9 CM PLATE
CASE PACK	6	6
CASE KG (CUBE M ³)	4,2 (0,023)	4,79 (0,022)

HK93CW is available in Beige (133).
HK39 is available in Antique White (148).

Camcarrier® for
HK93CW available by
special request. Call
Cambro Customer
Service for more
information.

Versa Camcovers®

Serve hot food hot with the Versa Camcover, an elegant and efficient alternative to traditional metal covers.

- Withstands temperatures up to 149°C.
- Covers remain cool to the touch for easy handling.
- Lighter and quieter than metal covers.
- Elegant appearance without polishing.
- Non-porous materials remain odor-free and resist stains.
- Keeps food warm longer than metal covers.
- Microwave safe.

Refer to the Cambro Camcover handbook on our website to determine what size Versa Camcover is best for your plates. Or, send one of your plates to Cambro Customer Service for sizing.

Colors: Ivory (380), Granite Grey (191), Antique Parchment (101).



Square Plate Camcovers

- Square shape fits popular square plate designs.
- Secure stacking for improved server safety; the foot of the plate nests securely on the top of the cover below.
- Elegant appearance with less noise during service.



1111SQVS Fits 27,9 cm Syracuse Quadra Plate

1212SQVS Fits 30,5 cm Syracuse Quadra Plate

85SFVS Fits 21,6 cm Oneida Sant' Andrea Fusion Plate

978SFVS Fits 25 cm Oneida Sant' Andrea Fusion Plate

99SMVS Fits 22,9 cm Steelite Metro/Quadro Plates

1111SMVS Fits 27,9 cm Steelite Metro/Quadro Plates

CODE	INSIDE DIAMETER	OUTSIDE HEIGHT	CASE KG (CUBE M ³)
Square			
1111SQVS	20,26 cm	7,30 cm	6,46 (0,020)
1212SQVS	30,80 cm	7,0 cm	7,03 (0,024)
99SMVS	23,2 cm	6,67 cm	4,54 (0,014)
1111SMVS	20,26 cm	7,0 cm	6,35 (0,021)
85SFVS	20,91 cm	7,0 cm	4,87 (0,012)
978SFVS	25,4 cm	7,0 cm	6,01 (0,017)
Round			
68VS	16,5 cm	5,6 cm	2,0 (0,014)
86VS	21,0 cm	6,7 cm	4,54 (0,013)
91VS	23,2 cm	6,8 cm	4,35 (0,015)
913VS	24,9 cm	6,8 cm	5,41 (0,015)
95VS	23,7 cm	6,8 cm	4,36 (0,015)
99VS	24,3 cm	6,7 cm	5,28 (0,015)
911VS	24,6 cm	7,0 cm	4,81 (0,018)
100VS	25,4 cm	6,8 cm	5,17 (0,015)
103VS	25,9 cm	6,8 cm	4,93 (0,016)
105VS	26,2 cm	6,8 cm	5,74 (0,017)
106VS	26,4 cm	7,2 cm	5,9 (0,020)
1010VS	27,0 cm	6,8 cm	6,14 (0,017)
1012VS	27,3 cm	6,8 cm	6,23 (0,0164)
1014VS	27,6 cm	6,8 cm	5,91 (0,017)
116VS	28,9 cm	8,1 cm	6,57 (0,019)
120VS	30,5 cm	7,3 cm	6,9 (0,021)
124VS	31,1 cm	7,3 cm	6,60 (0,027)

Case Pack: 12



Microwave safe!



Perfect for heated carts!

Camwear® Polycarbonate Camcovers®

Camwear Polycarbonate Camcovers

- Food stays hot and appetizing without re-heating.
- Ideal for use in heated carts.
- Safe up to 99°C.
- Virtually unbreakable polycarbonate will not dent or scratch.
- Lightweight for quiet service.
- Saves on labor with no polishing required.

Colors: Clear (152), Amber (153), Beige (133), Silver (486).

For help selecting the correct size plate cover, refer to the Camcover Sizing Guide on our website at www.cambro.com. Or, send one of your plates to Cambro Customer Service for sizing.

Personalization available. See crestring section for information and ordering.



CODE	INSIDE DIAMETER	OUTSIDE HEIGHT	CASE PACK	CASE KG (CUBE M ³)
806CW	21,4 cm	6,8 cm	12	2,37 (0,018)
900CW	23,2 cm	7,0 cm	12	2,9 (0,018)
901CW	23,7 cm	7,2 cm	12	3,54 (0,018)
905CW	24,1 cm	7,2 cm	12	3,5 (0,018)
909CW	24,8 cm	7,0 cm	12	3,4 (0,019)
9011CW	25,4 cm	7,3 cm	12	3,01 (0,022)
9013CW	25,4 cm	7,0 cm	12	3,3 (0,02)
1000CW	25,9 cm	6,8 cm	12	3,3 (0,02)
1005CW	26,8 cm	7,2 cm	12	3,8 (0,022)
1007CW	27,0 cm	7,0 cm	12	3,72 (0,022)
1013CW	27,5 cm	6,8 cm	12	3,71 (0,022)
1101CW	27,9 cm	6,8 cm	12	3,9 (0,022)
1202CW	30,8 cm	7,0 cm	12	4,25 (0,03)

Promote Your Brand

Personalize tumblers, barware, pitchers or other table service items with your logo or design. Use personalized drinkware in promotions.

Food storage products can also be personalized to identify menu items, add fill lines for recipes or to add instructions in multiple languages to help ensure product quality and consistency.



Look for this icon that identifies items that can be personalized.

IMPRINTING TABLE SERVICE AND STORAGE ITEMS

Minimum Quantity: 6 Cases

Sample Turnaround Time: 7-10 business days after receipt of approved artwork

Print Area: 6 mm to 10 cm, subject to printable area on each item

PERSONALIZATION CHARGES (NET)

Sample Charge: *** (Charge will be billed on sample order, credited on first purchase order)

Plate Charge: *** (Billed on sample order, one time charge)

Set-Up Charge: *** (Per order)

Cost Per Imprint: *** per side



CHOOSE ANY ONE OF THESE STANDARD IMPRINT COLORS



Due to the catalog printing process, the colors shown may not be exact.

www.cambro.com

HOW TO ORDER A SAMPLE

1. Request a Sample

Contact your local Cambro representative to complete and submit your sample request to Cambro.

2. Provide Artwork

Provide ready to use artwork, digital format only. Completed sample request form must be submitted to Cambro **PRIOR** to artwork being sent. If artwork is incomplete, graphic support services are available at *** per hour.

3. Submit Artwork

E-mail artwork to your Cambro Rep or direct to Cambro at letsgetpersonal@cambro.com. Title e-mail subject with logo name and provide contact info.

File dimensions: 100% reproduction size, 300dpi resolution.

File type:

Adobe® Illustrator®, Photoshop®.

File format: jpeg, tiff, and eps.

Or mail digital artwork to:
CEL - Attn: C.E.L. Customer Service, c/o DHL Solutions, Tradeboulevard 3, 4761 RL Moerdijk, Holland.

4. Questions regarding artwork?

Tel: 31-168-707-210;
Ireland Tel: 1800 509 046; for N.Ireland & UK,
Tel: 0800 587 0057 or
Fax: 31-168-707-211.

5. Sample Approval

A signed sample approval form must be faxed to Cambro customer service prior to processing any purchase orders. This form is included with each sample.

*** Contact your Cambro representative for pricing.

Camwear® Polycarbonate Pitchers

- Made of virtually unbreakable Camwear polycarbonate.
- Lightweight for easy handling.
- Exclusive ice-control contoured lip and pour spout reduce spills.
- Slotted base allows for complete and sanitary drying.

Color: Clear (135). P600CW is also available in Amber (153).

Capacities calculated to rim.

Personalization available. See cresting section for information, ordering and pricing.



P600CW, P480CW and P320CW
An industry standard. Broad base for stability, prevents tipping.



CODE	P320CW	P480CW	P600CW	P60CW
CAPACITY	0,95 L	1,4 L	1,8 L	1,8 L
HEIGHT WITH SPOUT	17 cm	20 cm	20,5 cm	23 cm
DIAMETER WITH HANDLE	14,5 cm	16 cm	17 cm	18,5 cm
CASE KG. (CUBE M³)	1,7 (0,02)	2,17 (0,022)	2,49 (0,026)	2,92 (0,030)

Case Pack: 6

PL60CW
Laguna® Pitcher has a hammered texture that hides scratches. Design matches the Laguna Tumbler. Pour liquids from front or ice and liquid from sides.

PE600CW
Economy polycarbonate pitcher. Lightweight design. Pour liquids from front or ice and liquid from sides.

P64CW
Tapered design and drip-proof spout.

PC64CW
Three position lid can strain ice, free pour or close to protect contents.



CODE	PL60CW	PE600CW	P64CW	PC64CW
CAPACITY	1,8 L	1,8 L	1,9 L	1,9 L
HEIGHT WITH SPOUT	20 cm	20 cm	23,5 cm	24,8 cm with lid
DIAMETER WITH HANDLE	17 cm	18,7 cm	18,5 cm	18,5 cm
CASE KG. (CUBE M³)	2,01 (0,033)	1,94 (0,03)	3 (0,04)	3,27 (0,034)

Case Pack: 6

Camwear® Polycarbonate Aliso® Barware, Goblets and Dessert Glass

Aliso Barware replicates the look, heft and clarity of glass with shatterproof polycarbonate. The smooth seamless appearance makes Aliso Barware a stylish choice for casual dining, outdoor events or for poolside service.

- Barware items have large, heavy bases for stability.
- Bases designed for fast draining and complete drying.
- Chill or frost barware without concerns of thermal shock damage.

Color: Clear (135).

Capacities calculated to rim.

Personalization available. See crestring section for information, ordering and pricing.



CODE	BWM10CW	BWW10CW	BWP14CW	BWB16CW	GB850CW	GB1200CW	DG3CW*
DESCRIPTION	Martini	Wine	Pilsner	Beer Mug	Goblet	Goblet	Dessert Glass
MAX DIAMETER	12,2 cm	7,5 cm	8,3 cm	12,1 cm	7 cm	7 cm	5,8 cm
MAX HEIGHT	17,5 cm	17,1 cm	24,3 cm	15,9 cm	15,9 cm	19,4 cm	7,7 cm
FULL SIZE CAMRACK®	9S638	25S638	25S958	16S638	36S534	36S738	49S318
CAPACITY TO RIM	310,5 mL	310,5 mL	458,4 mL	473 mL	266 mL	378 mL	100 mL
CASE PACK	12	24	24	12	24	24	72
CASE KG (CUBE M³)	3,7 (0,068)	2,8 (0,023)	7,16 (0,048)	3,4 (0,024)	2,46 (0,024)	3,06 (0,027)	4,08 (0,02)

*Available for ordering in cases only. No broken cartons.

Cambro® Tumblers

Cambro tumblers feature the look and feel of glass, but offer the cost savings and lightweight handling of break resistant plastic. These tumblers weigh up to 50% less than glass, making it easier and safer for wait staff to carry and serve beverages. Our tumblers cost about 33% less than comparable glassware. Less breakage means

lower replacement costs and less staff time spent cleaning up broken glass. All of our tumblers feature stacking lugs for easy stacking, transport and storage and are dishwasher safe.

Expand your service options! Valued by restaurants, hospitals and schools, Cambro tumblers are ideal anywhere you want the upscale

look of glass without the worry of breakage. Our elegant designs are ideal for outdoor catering and resort use. Whatever your need, there is a Cambro tumbler perfect for your operation.

Elegant Design



HUNTINGTON®
Elegant Design, Unbreakable



LAGUNA®
Hammered Texture



NEWPORT
Fluted Design



DEL MAR®
Crackled Glass Look

RECOMMENDED USE: Poolside Service, Outdoor Dining, Catering, Bars, Room Service, Hotels & Resorts, Weddings, Corporate Events, Country Clubs, Water Front Dining and Theme Parks.

All Purpose



COLORWARE
Value Tumbler



CAMWEAR® POLYCARBONATE
Virtually Unbreakable



PERSONALIZATION
Available on all tumblers



Camrack® IceExpress Glass Filler

- Dramatically reduces banquet set-up time.
 - Fills 25 glasses with ice all at once.
 - Reduces breakage and risk of contamination.
 - Ice falls directly into glasses with no spills or drips.
- See Camrack® Section for more details

RECOMMENDED USE: Family Dining, Pizzeria, Hospital, Cafeteria, Schools, Nursing Homes.



Add your logo to promote your establishment and build customer loyalty. See personalization page for details.

CamLid®

- Disposable lids fit tightly on Newport, Laguna, and Colorware tumblers, avoiding spills.
- Provides a “green” solution to reduce the waste of using disposable cups for kids’ drinks.
- Reusable tumblers save operators the expense of replacing disposable kids’ cups.
- Tumblers are available in clear, which allows for visibility of contents.
- Doubles as an employee drink cup that requires a lid.
- Lids have tumbler code imprinted on them for easy cross reference.
- Includes a cross slot for straws.
- Tumblers can be personalized with logos or exclusive designs.



*Available for ordering in cases only.
No broken cartons.



Disposable Lids for Colorware Tumblers



LID CODE	CL900P	CL950P
FITS TUMBLERS	900P / 900P2	950P / 950P2
TUMBLER CAPACITY	287 mL	290 mL
CASE PACK	1,000	1,000
CASE KG (CUBE M ³)	2,72 (0,03)	2,72 (0,03)

Color: Translucent (190).

Disposable Lids for Laguna® Tumblers



LID CODE	CLLT6	CLLT10	CLLT12
FITS TUMBLERS	LT6	LT10	LT12
TUMBLER CAPACITY	177,4 mL	295,7 mL	354,9 mL
CASE PACK	1,500	1,000	1,000
CASE KG (CUBE M ³)	2,72 (0,03)	2,72 (0,03)	2,72 (0,03)

Color: Translucent (190).

Disposable Lids for Newport Tumblers



LID CODE	CLNT5	CLNT8	CLNT10	CLNT12	CLNT20
FITS TUMBLERS	NT5	NT8	NT10	NT12	NT20
TUMBLER CAPACITY	189 mL	228 mL	300 mL	373 mL	650 mL
CASE PACK	1,500	1,000	1,000	1,000	1,500
CASE KG (CUBE M ³)	2,72 (0,03)	2,72 (0,03)	2,72 (0,03)	2,72 (0,03)	2,27 (0,03)

Color: Translucent (190).

Camwear® Polycarbonate Huntington® & SAN Newport Tumblers

Huntington Tumblers

- Feature the elegant look and feel of glass without the high replacement costs.
- Made of virtually unbreakable polycarbonate
- Lightweight.
- Stacking lugs to prevent sticking
- Three sided drain bottom for easy washing and drying.

Colors: Azure Blue (196), Clear (135).

Capacities calculated to rim.

Personalization available. See crestring section for information and ordering.

Huntington Tumblers are covered by the following U.S. Patents D 386,047.



CODE	HT5CW	HT8CW	HT10CW	HT120CW	HT12CW	HT14CW	HT16CW	HT22CW
MAX DIAMETER	6,0 cm	6,8 cm	7,1 cm	7,6 cm	8,6 cm	8,3 cm	8,4 cm	8,9 cm
MAX HEIGHT	9,0 cm	11,3 cm	12,2 cm	12,8 cm	9,5 cm	12,4 cm	14 cm	17 cm
FULL SIZE CAMRACK®	49S318	36S418	36S434	25S434	25S418	25S434	25S534	25S638
CAPACITY TO RIM	148 mL	237 mL	296 mL	355 mL	355 mL	414 mL	473 mL	652 mL
CASE PACK	36	36	36	36	36	36	36	36
CASE KG (CUBE M³)	1,75 (0,008)	2,37 (0,011)	3,27 (0,0127)	3,26 (0,015)	3,17 (0,018)	1,55 (0,016)	3,9 (0,02)	4,78 (0,025)

Newport Tumblers

- Fluted design features the upscale look of glass with the safety benefits and cost savings of plastic.
- Impact resistant SAN plastic resists chips and breaks.
- Stacking lugs prevent sticking.
- Sani-Rim lip provides a sanitary drinking surface.

Colors: Clear (152), Blush (409), Amber (153), Slate Blue (401).

Capacities calculated to rim.

Personalization available. See crestring section for information and ordering.

Liquids in SAN cannot exceed 85°C.



CODE	NT5	NT8	NT9	NT10	NT12	NT14	NT16	NT20
MAX DIAMETER	6,4 cm	6,8 cm	8,3 cm	7,1 cm	7,6 cm	7,9 cm	8,3 cm	8,7 cm
MAX HEIGHT	9,4 cm	10,2 cm	8,4 cm	11,6 cm	13 cm	12,7 cm	14,6 cm	16,5 cm
FULL SIZE CAMRACK®	36S318	36S418	25S318	36S434	25S434	25S434	25S534	25S638
CAPACITY TO RIM	189 mL	228 mL	275 mL	300 mL	373 mL	414 mL	485 mL	650 mL
CASE PACK	36	36	36	36	36	36	36	36
CASE KG (CUBE M³)	1,6 (0,0082)	1,96 (0,0096)	2,1 (0,0096)	2,39 (0,0127)	2,55 (0,0139)	2,8 (0,0209)	3,08 (0,0232)	3,9 (0,0215)

SAN Laguna® & Del Mar® Tumblers

Laguna Tumblers

- Hammered texture hides water spots and scratches.
- Made of impact resistant SAN.
- Lightweight and easy to carry.

Colors: Clear (152), Spanish Green (427).

Capacities calculated to rim.

Personalization available. See crestring section for information, ordering and pricing.

Laguna Tumblers are covered by the following U.S. Patent D 405,319.

Liquids in SAN cannot exceed 85°C.



CODE	LT6	LT8	LT10	LT12	LT14	LT16	LT22
MAX DIAMETER	6,3 cm	6,9 cm	7,4 cm	7,9 cm	8,3 cm	8,4 cm	9,3 cm
MAX HEIGHT	10,7 cm	10,9 cm	12,1 cm	12,7 cm	13,1 cm	14 cm	15,4 cm
FULL SIZE CAMRACK®	36S418	36S418	36S434	25S434	25S434	25S534	16S534
CAPACITY TO RIM	177,4 mL	236,6 mL	295,7 mL	354,9 mL	414 mL	473,2 mL	650,6 mL
CASE PACK	36	36	36	36	36	36	36
CASE KG (CUBE M³)	1,94 (0,010)	2,31 (0,013)	2,5 (0,015)	2,92 (0,017)	2,97 (0,019)	3,52 (0,021)	4,58 (0,030)

Del Mar Tumblers

- Crackled glass look features the lightweight handling of plastic.
- Thick sturdy base and rolled rim edge for added stability.
- Made of impact resistant SAN plastic.

Colors: Clear (152), Ruby Red (156), Sapphire Blue (608), Light Amber (609).

Capacities calculated to rim.

Personalization available. See crestring section for information, ordering and pricing.

Del Mar Tumblers are covered by the following U.S. Patent D 478,778 S.

Liquids in SAN cannot exceed 85°C.



CODE	D8	D12	D14	D16	D24
MAX DIAMETER	6,7 cm	7,5 cm	8,3 cm	7,8 cm	8,7 cm
MAX HEIGHT	10,6 cm	12,0 cm	8,3 cm	15,1 cm	16,8 cm
FULL SIZE CAMRACK	36S418	25S434	25S318	25S534	25S638
CAPACITY TO RIM	237 mL	355 mL	414 mL	473 mL	710 mL
CASE PACK	36	36	36	36	36
CASE KG (CUBE M³)	2,2 (0,010)	3 (0,014)	3,4 (0,018)	3,9 (0,019)	5 (0,026)

SAN Colorware Tumblers & Coca-Cola® Tumblers

- A classic value tumbler ideal for casual dining.
- Textured on the outside to resist scratching.
- Made of impact resistant SAN
- Interior stacking lugs for easy storing.
- Sani-Rim lip provides a sanitary drinking surface.

Colors: Blush (409), Slate Blue (401), Clear (152), Amber (153), Ruby Red (156).

Capacities calculated to rim.

Personalization available. See crestring section for information and ordering.

Liquids in SAN cannot exceed 85°C.



	500P	800P	900P	950P	1200P	1600P	2000P	—
CODE (72 PACK)	500P	800P	900P	950P	1200P	1600P	2000P	—
CODE (24 PACK)	500P2	800P2	900P2	950P2	1200P2	1600P2	2000P2	3200P2
MAX DIAMETER	5,7 cm	6,7 cm	8,1 cm	7,0 cm	7,5 cm	8,0 cm	8,6 cm	10 cm
MAX HEIGHT	9,2 cm	10,2 cm	8,25 cm	11,1 cm	13,2 cm	14,6 cm	16,5 cm	18,4 cm
FULL SIZE CAMRACK®	49S318	36S418	25S318	36S418	25S434	25S534	25S638	16S738
CAPACITY TO RIM	154 mL	231 mL	287 mL	290 mL	373 mL	485 mL	650 mL	976 mL
P CODE-CASE PACK	72	72	72	72	72	72	72	—
P2 CODE-CASE PACK	24	24	24	24	24	24	24	24
72 PK-CASE KG (CUBE M³)	3,43 (0,013)	3,58 (0,016)	3,83 (0,019)	4,33 (0,021)	2,29 (0,024)	6,7 (0,03)	7,7 (0,036)	—
24 PK-CASE KG (CUBE M³)	0,98 (0,005)	1,25 (0,006)	1,32 (0,007)	1,5 (0,007)	1,75 (0,008)	2 (0,015)	2,64 (0,013)	3,59 (0,020)

Coca-Cola® Tumblers

- Colorware Tumblers featuring the Coca-Cola trademark logo in White.
- Available only to Coca-Cola fountain customers for foodservice use.

Colors: Clear (152).

Coca-Cola Logo is imprinted in White only.

These trademarked vessels may not be resold at retail and are available only for distribution to Coca-Cola Fountain customers for foodservice use.

Liquids in SAN cannot exceed 85°C.



CODE	20CC	32CC
MAX DIAMETER	8,6 cm	10 cm
MAX HEIGHT	6,4 cm	7,3 cm
FULL SIZE CAMRACK	25S638	16S738
CAPACITY TO RIM	650 mL	976 mL
CASE PACK	72	24
CASE KG (CUBE M³)	7,7 (0,036)	3,56 (0,020)

Camwear® Polycarbonate Tumblers & Camliters®

Camwear Polycarbonate Tumblers

- The look and feel of glass but made of virtually unbreakable polycarbonate.
- Textured exterior surface resists scratching.
- Smooth interior promotes easy cleaning.
- Designed with a Sani-Rim lip for sanitary drinking.

Color: Clear (152).
 Capacities calculated to rim.
 Personalization available. See crestring section for information and ordering.



CODE	500CW	800CW	850CW	950CW	1200CW	1600CW
MAX DIAMETER	5,7 cm	6,7 cm	8,6 cm	7,0 cm	7,5 cm	7,9 cm
MAX HEIGHT	9,2 cm	10,2 cm	9,7 cm	11,1 cm	13,2 cm	14,6 cm
FULL SIZE CAMRACK®	49S318	36S418	25S418	36S418	36S434	25S534
CAPACITY TO RIM	160 mL	237 mL	269 mL (Heavy Wall)	284 mL	384 mL	503 mL
CASE PACK	48	48	48	48	48	48
CASE KG (CUBE M³)	1,92 (0,008)	2,51 (0,012)	4,31 (0,017)	3 (0,015)	4 (0,02)	4,3 (0,023)

Camwear Polycarbonate Camlitter Beverage Decanters

- Ideal for serving juice or wine on buffet lines or table side.
- Virtually unbreakable Camwear polycarbonate will not dent or scratch. Lightweight.
- Camlitters ship with spill-proof flat lids.
- Pour Spout Lid, ordered separately, protects contents while allowing a free pour.

Color: Clear (135).
 Lid Color: White (148).
 Pour Spout Lid is not NSF listed.



CODE	CAPACITY	HEIGHT	CASE KG. (CUBE M³)
Camlitters complete with lids: (WW1000L, WW250L)			
WW1500CW	1,5 L	25,4 cm	3,86 (0,445)
WW1000CW	1 L	24,8 cm	3,3 (0,03)
WW500CW	0,5 L	20,0 cm	2 (0,02)
WW250CW	0,25 L	15,9 cm	0,059 (0,01)
Lids			
WW1000LS	(lid w/pour spout for 1,5 L, 1 L, and 0,5 L)		0,091 (0,001)
WW1000L	(lid for 1,5 L, 1 L and 0,5 L)		0,28 (0,001)
WW250L	(lid for 0,25 L)		0,2 (0,001)

Case Pack: 12 Pour Spout Lid must be ordered separately.



Beverage Dispenser, Pail with Bail & Swirl Bowls®

21 L Beverage Dispenser

- Perfect for mixing and serving concentrated beverages.
- Standard and metric graduations are printed on dispenser.
- Impact resistant polyethylene withstands temperatures from -40°C to 70°C.

Color: White (148).

Personalization available. See cresting section for information and ordering.



CODE	CAPACITY	CASE KG (CUBE M ³)
DSPR6	21 L	1,72 (0,043)

Case Pack: 1



DSPR6
Capacity: 21 L

Pail with Bail – Poly

- A large, multi-purpose, 21 L pail, ideal for mixing, storing and transporting.
- Durable polyethylene withstands temperatures from -40°C to 70°C, and is stain resistant.
- Snap-tight, thumb tab cover sold separately.



CODE	CASE KG (CUBE M ³)
PWB22	6,5 (0,09)
RFSC12 (cover)	1,6 (0,01)

Case Pack: 6 Color: White (148).



All graduations are approximate.

Swirl Bowls

- Ideal for hot or cold side dishes, desserts, dips, or fruit.
- Fits on a plate or stacks in place on a buffet station.
- Available in virtually unbreakable Camwear® polycarbonate or break resistant SAN.

Colors:

SRB5CW and SRB13CW available in: Clear (135), Black (110), White (148).

SRB5 and SRB13 available in: Clear (152), Black (110), White (148).



CLSRB5 Disposable lid not NSF.



Disposable lid available



SRB13CW

SRB5CW



CODE	CAPACITY	CASE PACK	CASE KG (CUBE M ³)
Camwear Polycarbonate			
SRB5CW	148 mL	24	1,33 (0,0064)
SRB13CW	384 mL	24	2,34 (0,009)
SAN			
SRB5	148 mL	24	1,36 (0,0064)
SRB13	384 mL	24	2,02 (0,009)
Disposable Lid			
CLSRB5	—	1,000	10 (2,24)

Disposable Lid Color: Clear (152).

Camwear® Polycarbonate Wine Buckets, Punch Bowls & Bud Vase

Wine Buckets

- Chill and showcase wine or champagne.
- Tough Camwear polycarbonate won't crack or break and is easy to clean.
- Chrome stand available for space saving table side service.

Color: Clear (135).
Stand Color: Chrome (136).

Personalization available. See cresting section for information and ordering.



CODE	DIMENSION D x H	CASE KG (CUBE M³)
Bucket		
WC100CW	20,3 x 23,2 cm	1 (0,014)
WC100CWNH (w/o handles)	20,3 x 22,9 cm	0,79 (0,014)
Stand		
WCS30		1,81 (0,04)

Case Pack: 1



WC100CW



WC100CWNH

WCS30

Pebbled Pedestal Punch Bowls

- Perfect for parties, weddings and receptions.
- Made of virtually unbreakable Camwear polycarbonate.
- Attractive pebbled exterior is scratch resistant and smooth interior is easy to clean.

Color: Pebbled (176).

Capacities are calculated to rim.

Personalization not available.



CODE	INSIDE DIAMETER	APPROX. CAPACITY	CASE PACK	CASE KG (CUBE M³)
PPB15	38,1 cm	10,6 L	1	1,18 (0,036)
PPB18	45,7 cm	19,1 L	1	2,09 (0,06)
PPB23	58,4 cm	37,8 L	1	3,81 (0,13)

Bud Vase

- Ideal for dining rooms, cafeteria tables and patient or room service trays.
- Made of virtually unbreakable Camwear polycarbonate.
- Fill with a fresh rose bud or a colorful faux flower.

Colors: Clear (135), White (148).



White (148)

Clear (135)



CODE	DESCRIPTION	CASE PACK	CASE KG (CUBE M³)
BV6CW	15,24 cm Bud Vase	12	1 (0,010)

FOOD PRESENTATION



Deli Crocks & Platter

- Prep, store and serve all in one with contemporary style at an economical price.
- Crocks and platter are made of SAN, making them impact, stain and chip resistant.
- Ideal for supermarket delis, sandwich shops, buffets and catered events.
- Handled covers are made of crystal clear, virtually unbreakable Camwear® polycarbonate.

Crock and Platter Colors: Clear (152), Black (110), White (148), Red (404).

Crock Cover Color: Clear (135).

Deli Crocks are covered by the following U.S. Patents D 504,283 S, D 503,871 S & D 494,419 S. Scalloped Food Service Cover is covered by the following U.S. Patent D 509,705 S.



Prep, stack, store and serve all in one.



Interstacking saves storage space.



Avoid cross contamination and keep food fresh by using clear cover with handle.



Lid can be used as a riser to provide additional height on the buffet table or in a deli display case.



Cover doubles as a false bottom for presentation and to reduce waste.

Crocks & Platter



CODE	DC5	DC10	DP15
DESCRIPTION	Crock	Crock	Platter
DIMENSIONS W x L x H	17,5 x 26 x 8 cm	26,5 x 33,5 x 8 cm	40 x 30,5 x 5,5 cm
APPROXIMATE CAPACITY	2 L	4,6 L	3,2 L
CASE KG (CUBE M ³)	1,78 (0,010)	3,08 (0,02)	2,81 (0,014)

Case Pack: 6

Covers



CODE	DCC5 fits DC5	DCC10 fits DC10
DIMENSIONS W x L x H	15 x 23,8 x 3,5 cm	24 x 31 x 3,5 cm
APPROXIMATE CAPACITY	0,85 L	1,9 L
CASE KG (CUBE M ³)	2,95 (0,014)	2,27 (0,011)

Case Pack: 6



ShowFest® Display Bowls & Trays

- Showcase cold deli, buffet and salad bar items.
- Made from SAN for impact, stain, break & chip resistance.
- Variety of shapes & sizes to make the best use of display area.

Colors: Black (110), White (148).

Personalization not available.

Triangle trays are covered under U.S. Patent D 419,364.



Scalloped Ovals



CODE	SFV1015
DIM. W x L x H	25,4 x 38 x 5 cm
APPROX. CAPACITY	2,8 L
CASE KG (CUBE M³)	2,08 (0,017)
Case Pack:	6

Scalloped Rectangles



CODE	SFR1012
DIM. W x L x H	25,4 x 31,8 x 7,6 cm
APPROX. CAPACITY	4,3 L
CASE KG (CUBE M³)	2,33 (0,013)
Case Pack:	6



Octagonals



CODE	SFG1012	SFG1015	SFG820	SFG1220
DIM. W x L x H	25,4 x 30,5 x 5 cm	25,4 x 38 x 5 cm	20,3 x 50,8 x 5 cm	30,5 x 50,8 x 5 cm
APPROX. CAPACITY	2,8 L	3,3 L	3,7 L	5,8 L
CASE KG (CUBE M³)	2,04 (0,0115)	2,63 (0,0143)	3,26 (0,0147)	5,04 (0,0218)
Case Pack:	6			

Triangles



CODE	SFT1010	SFT1212	SFT1515
DIM. W x L x H	25,4 x 30,5 x 6,4 cm	30,5 x 38 x 6,4 cm	38 x 50,8 x 6,4 cm
APPROX. CAPACITY	1,9 L	2,8 L	4,2 L
CASE KG (CUBE M³)	1,27 (0,011)	1,72 (0,015)	2,74 (0,023)
Case Pack:	6		

Camwear® Polycarbonate Bowls

Round Pebbled Bowls

- Textured on the outside for an elegant look, smooth on the inside for easy cleaning.
- Made of virtually unbreakable Camwear polycarbonate for years of dependable service.
- Ideal for fruit, salads, snacks and desserts.

Color: Pebbled (176).

Capacities are calculated to rim.



Ribbed Bowls

- Stylish, contemporary appearance for a dramatic presentation.
- Made of virtually unbreakable Camwear polycarbonate that won't break like glass.
- Bowls are durable and lightweight. Will not chip and crack like acrylic.
- Resistant to stains, acids and odors.

Colors: Clear (135), Black (110), White (148)*.

* Rectangular Ribbed Bowls are not available in White (148).

Capacities are calculated to rim.



Round Pebbled Bowls

CODE	PSB6	PSB8	PSB10	PSB12
INSIDE DIAMETER	15,2 cm	20,3 cm	25,4 cm	30,5 cm
APPROXIMATE CAPACITY	556 mL	1,7 L	3,0 L	5,5 L
CASE PACK	12	12	12	12
CASE KG (CUBE M ³)	1,03 (0,005)	2 (0,012)	4,2 (0,022)	6 (0,04)

Round Pebbled Bowls



CODE	PSB15	PSB18	PSB23
INSIDE DIAMETER	38,1 cm	45,7 cm	58,4 cm
APPROXIMATE CAPACITY	10,6 L	19,1 L	37,8 L
CASE PACK	4	4	4
CASE KG (CUBE M ³)	2,67 (0,034)	5,69 (0,06)	9 (0,1)

Color: Pebbled (176).

Rectangular Ribbed Bowls



CODE	RSB912CW	RSB1014CW	RSB1419CW
OUTSIDE DIAMETER	22,9 x 30,8 cm	27,3 x 37 cm	36,2 x 49,2 cm
APPROXIMATE CAPACITY	2,7 L	4,7 L	11,3 L
CASE PACK	12	4	4
CASE KG (CUBE M ³)	4 (0,02)	2,11 (0,015)	4 (0,03)

Rectangular Ribbed Bowls are not available in White (148).

Round Ribbed Bowls



CODE	RSB6CW	RSB8CW	RSB10CW	RSB12CW
INSIDE DIAMETER	15,2 cm	20,3 cm	25,4 cm	30,5 cm
APPROXIMATE CAPACITY	564 mL	1,6 L	3,0 L	5,5 L
CASE PACK	12	12	12	12
CASE KG (CUBE M ³)	1 (0,005)	2,69 (0,015)	5,3 (0,026)	9 (0,05)



CODE	RSB15CW	RSB18CW	RSB23CW
INSIDE DIAMETER	38,1 cm	45,7 cm	58,1 cm
APPROX. CAPACITY	10,6 L	9,1 L	37,8 L
CASE PACK	4	4	4
CASE KG (CUBE M ³)	5,5 (0,04)	6,08 (0,06)	10 (0,1)

Bell Shaped, Budget & Fiberglass Bowls

Camwear® Polycarbonate Bell-Shaped Pebbled Bowls

- Perfect for showcasing fruits and salads.
- A versatile alternative to Cambro traditional Round Pebbled Bowls.
- Made from virtually unbreakable Camwear polycarbonate.

Color: Pebbled (176).
 Personalization not available.
 Capacities are calculated to rim.



CODE	BSB10	BSB12	BSB18
INSIDE DIAMETER	25,0 cm	30,5 cm	45,7 cm
APPROX. CAPACITY	2,0 L	3,8 L	11,8 L
CASE PACK	12	4	4
CASE KG (CUBE M ³)	3,18 (0,014)	1,71 (0,014)	4 (0,04)

Budget Salad Bowls

- An economical serving choice for fruit, salads, snacks and desserts.
- Impact resistant FDA approved material resists stains, acids and odors.

Colors: Birch (174), Black (110).
 Personalization not available.
 Capacities are calculated to rim.



CODE	SB55	SB60	SB80
INSIDE DIAMETER	14,5 cm	15,2 cm	20,3 cm
APPROX. CAPACITY	325 mL	375 mL	925 mL
CASE KG (CUBE M ³)	3,27 (0,014)	4,01 (0,015)	9 (0,03)

Case Pack: 72



Fiberglass Bowls

- Combines the look of warm wood grains with the durability of fiberglass.
- Colors won't fade even after years of service and washing.

Color: Dark Basketweave (301).
 Personalization not available.
 For a swatch of this color and pattern, see Camtray® group section.
 Capacities are calculated to rim.



CODE	6F	8F
INSIDE DIAMETER	15,6 cm	20,3 cm
APPROX. CAPACITY	425 mL	925 mL
CASE KG (CUBE M ³)	1,05 (0,003)	1,8 (0,006)

Case Pack: 12



Camwear® Polycarbonate Display Covers & Trays

- Display covers protect freshness of pastries, breads and desserts.
- Virtually unbreakable Camwear polycarbonate features the upscale look of glass.
- Openings on side or end provide quick and easy access to contents without removing cover.

Display Covers

Color: Clear (135).

Personalization available. See crestring section for information and ordering.

* Height on covers without handle. Handle height is 3 cm.

Market Trays

Colors: Salmon (149), Yellow (145), Blue (142), Green (140), White (148), Black (110).

Colors NSF listed for food contact: White (148), Blue (142), Green (140).

Display Trays

Colors: Clear (135), Black (110).

Personalization not available.

** Special order item not carried in stock – non-returnable.



Display Trays are stackable. Refer to page 47 for Market Tray information.



RD1220CW



RD1220CWH



RD1200CW



DD1220BECW



Display Tray – DT1220CW



Dome with side cut – DD1220SCW

CODE	APPROXIMATE DIMENSIONS W x L x H*	DESCRIPTION	CASE PACK	CASE KG (CUBE M ³)
Display Covers				
RD1200CW	30,5 cm	Cake cover	1	0,97 (0,021)
DD1220CW	30,5 x 50,8 x 16,8 cm	Dome cover	1	1,91 (0,044)
DD1220ECW	30,5 x 50,8 x 16,8 cm	Dome w/end cut	1	1,71 (0,044)
DD1220BECW	30,5 x 50,8 x 16,8 cm	Dome w/2 ends cut	1	1,63 (0,046)
DD1220SCW	30,5 x 50,8 x 16,8 cm	Dome w/side cut	1	1,72 (0,050)
DD1826CW	45,7 x 66 x 17,8 cm	Dome cover	1	2,36 (0,08)
RD926CW	22,9 x 66 x 17,8 cm	Rectangular cover	1	1,49 (0,03)
RD1220CW	30,5 x 50,8 x 16,8 cm	Rectangular cover	1	1,84 (0,031)
RD1220CWH	30,5 x 50,8 x 16,8 cm	Rectangular w/hinge	1	1,88 (0,026)
RD1826CW	45,7 x 66 x 12 cm	Rectangular cover	1	3 (0,055)
RD1826CWH	45,7 x 66 x 12 cm	Rectangular w/hinge	1	2,65 (0,045)
Display Tray – Fits with all 1220 covers				
DT1220CW	30,5 x 50,8 cm	Tray	1	0,39 (0,008)
Market Tray – Fits with all 1826 covers				
1826MT**	45,2 x 65,2 x 2,7 cm	Tray	6	7,06 (0,025)

Crocks & Ladles

Crocks

- Ideal for use with salad bars, on buffet tables or at food stations.
- Resists stains and odors caused by vinegar, salad oils, or mayonnaise.
- Made of high impact FDA accepted material.
- Smooth surface is easy-to-clean.

Solid Color Crock Colors: Cranberry (416), Black (110), Beige (133), Reddish Brown (195).

Clear Crock Color: Clear (152).
Lid Color: White (148).

Personalization available. See personalization section for details.

* Lids for Solid Color and Clear Crocks are not interchangeable.



CODE	HEIGHT	TOP DIAMETER	CUT OUT DIAMETER
Solid Color Crock with Lid			
CP12	13,2 cm	12,9 cm	12,1 cm
CP15	11 cm	16,8 cm	15,7 cm
CP27	17,2 cm	16,8 cm	15,6 cm
Clear Color Crock with Lid			
CCP12	13,7 cm	13,3 cm	12,4 cm
CCP15	11,1 cm	17,2 cm	15,9 cm
CCP27	17,5 cm	17,2 cm	15,7 cm

CODE	CAPACITY	CASE PACK	CASE KG (CUBE M ³)
Solid Color Crocks			
CP12	1,1 L w/Lid	12	2,98 (0,029)
CP15	1,4 L w/Lid	6	1,91 (0,02)
CP27	2,4 L w/Lid	6	2,53 (0,031)

Lids for Solid Color Crocks			
CPL12*	Fits Colored CP12 Crock	12	0,36 (0,003)
CPL27*	Fits Colored CP15 & CP27	12	0,59 (0,004)

Clear Crocks			
CCP12	1,1 L w/Lid	12	3,44 (0,029)
CCP15	1,4 L w/Lid	6	2,18 (0,02)
CCP27	2,4 L w/Lid	6	3 (0,03)

Lids for Clear Crocks			
CCPL12*	Fits Clear CCP12 Crock	12	2,8 (0,03)
CCPL27*	Fits Clear CCP15 & CCP27	12	6,02 (0,004)

Camwear® Polycarbonate Ladles

- Portion control bowls serve the perfect amount of dressing or food ingredient.
- Angled for easy handling.
- Designed with a side rest so ladles don't slip into crocks or serving bowls.
- Made of virtually unbreakable Camwear polycarbonate for years of dependable service.

Colors: Black (110), Beige (133), Clear (135), White (148), Reddish Brown (195).

* Cambro's assortment pack offers 8 imprinted ladles and 4 with no imprinting. 8 imprints include: 1 each Thousand Island, French, House, Italian, Bleu Cheese, Ranch, Low Cal, Caesar. This makes a perfect start-up set for a salad bar.

Custom Order Ladle Imprints – See creasing section for information and ordering. Maximum imprint area is 2,5 x 1,2 cm. Six dozen minimum.

No broken cartons on assortment pack or imprinted ladles. Special order item not carried in stock, non-returnable.



* Imprinted Ladles shown.

CODE	DESCRIPTION	LENGTH	CAPACITY	CASE KG (CUBE M ³)
LD85	Plain	21,6 cm	25 mL	0,5 (0,003)
LD85A*	Assortment	21,6 cm	25 mL	0,5 (0,003)
LD105	Plain	26,8 cm	30 mL	0,6 (0,004)
LD105A*	Assortment	26,8 cm	30 mL	0,6 (0,004)
LD130	Plain	33 cm	30 mL	0,63 (0,004)
LD130A*	Assortment	33 cm	30 mL	0,63 (0,004)

Case Pack: 12

Camwear® Polycarbonate Serving Spoons, Tongs & High Heat Camtensils®

Camwear Serving Spoons

- Made of virtually unbreakable polycarbonate, Camwear spoons won't tarnish, bend or dent.
- A wide handle and molded in thumb rest ensures a solid, ergonomic grip.
- Spoons feature a notched back to rest on pans.
- Spoon capacities are approximate and are not intended for measuring.

Colors: Black (110), Beige (133), Clear (135), Red (404), White (148).

Personalization available. See crestring section for information, ordering and pricing.



Camwear Polycarbonate Perforated Serving Spoons



CODE	SPOP10CW	SPOP11CW	SPOP13CW
DESCRIPTION	25,5 cm Perforated Buffet Spoon	28 cm Perforated Deli Spoon	33 cm Perforated Deli Spoon
DIMENSIONS	26 x 4,3 cm	28,3 x 7,3 cm	33,3 x 7,3 cm
CASE KG (CUBE M³)	0,3 (0,001)	0,45 (0,003)	1,0 (0,007)

Case Pack: 12

Camwear Polycarbonate Serving Spoons



CODE	SP08CW	SP010CW	SP011CW	SP013CW
DESCRIPTION	20,5 cm Salad Spoon	25,5 cm Buffet Spoon	28 cm Deli Spoon	33 cm Deli Spoon
DIMENSIONS	20,6 x 3,8 cm	26 x 4,3 cm	28,3 x 7,3 cm	33,3 x 7,3 cm
CASE KG (CUBE M³)	0,25 (0,0008)	0,3 (0,001)	0,68 (0,003)	1,01 (0,007)

Case Pack: 12



High Heat Camtensil Spoons and Turners

- Ideal for preparing and serving hot and cold foods.
- Made of a durable high heat material that withstands temperatures from -40°C to 190°C.
- Handle includes a hole for hanging when not in use and notches to rest on pans.

Color: Amber (150), Black (110).

Personalization not available.



High Heat Camtensil Spoons and Turners



CODE	SP011	SP013	SPA14
DESCRIPTION	28 cm Deli Spoon	33 cm Solid Spoon	35,5 cm Solid Turner
DIMENSIONS	28,3 x 7,3 cm	33,3 x 7,3 cm	35,9 x 8,9 cm
CASE KG (CUBE M³)	0,9 (0,003)	1,07 (0,007)	1,54 (0,009)

Case Pack: 12

High Heat Camtensil Perforated Spoons and Slotted Turners



CODE	SPOP11	SPOP13	SPASL14
DESCRIPTION	28 cm Perforated Spoon	33 cm Perforated Spoon	35,5 cm Slotted Turner
DIMENSIONS	28,3 x 7,3 cm	33,3 x 7,3 cm	35,9 x 8,9 cm
CASE KG (CUBE M³)	0,68 (0,003)	1,07 (0,007)	1,63 (0,009)

Case Pack: 12

Lugano® Tongs

- Colored tongs are made from a durable heat resistant material that withstands temperatures up to 149°C.
- Ideal for serving cold and hot food, even from steam tables.
- Clear tongs are made from virtually unbreakable polycarbonate, which is safe to 99°C.

Lugano Flat and Scallop Grip Tongs

- Easily grasp hard to hold items such as salad greens and tomatoes.
- Scallop Tongs feature an ergonomic design and secure finger grip.
- Flat Tongs are ribbed to provide a secure hold.

Colors: Black (110), Beige (133), * Clear (135), ** Red (404), White (148).

Two year warranty on colored tongs.

* Clear is safe to 99°C.
** Red is NSF listed to 99°C.



Lugano Angled and Easy-Grasp Tongs

- Angled tongs feature an ergonomic design that makes it easy to serve a variety of foods.
- Easy-Grasp Tongs combine a fork and spoon, providing a secure grip for hard to hold items.

Colors: Black (110), Beige (133), Clear (135), White (148).

Two year warranty on colored tongs.

Angled and Easy-Grasp Lugano Tongs are covered under U.S. Patent D 530,994 S.

Easy-Grasp Lugano Tongs are not NSF listed.



Flat Grip Tongs



CODE	TG6	TG9
LENGTH	15 cm	23 cm
CASE KG (CUBE M ³)	0,34 (0,001)	0,74 (0,006)

Case Pack: 12

Scallop Grip Tongs



CODE	6TGS	9TGS	12TGS
LENGTH	15 cm	23 cm	30,5 cm
CASE KG (CUBE M ³)	0,37 (0,002)	0,83 (0,004)	1,16 (0,006)

Case Pack: 12

Angled Tongs



CODE	TGA8	TGA11
DESCRIPTION	Angled Tong	Angled Tong
DIMENSIONS	21 cm	27,5 cm
CASE KG (CUBE M ³)	1 (0,061)	1,3 (0,007)

Case Pack: 12

Easy-Grasp Tongs



CODE	TGG6	TGG9
DESCRIPTION	Easy-Grasp Tong	Easy-Grasp Tong
DIMENSIONS	15 cm	24 cm
CASE KG (CUBE M ³)	0,63 (0,004)	1,05 (0,007)

Case Pack: 12



Camwear® Polycarbonate Shakers/Dredges & Condiment Jars

Camwear Polycarbonate Shakers/Dredges

- A staple in the kitchen, at the condiment station or on the dining table.
- Clear virtually unbreakable Camwear® polycarbonate and color coded lids make it easy to identify contents.
- Dishwasher safe and unaffected by food acids.

Shaker Color: Clear (135).

Personalization available. See crestring section for information, ordering and pricing.



96SKRLF
Fine Ground



96SKRLD
Salt & Pepper



96SKRLM
Med. Ground



96SKRLC
Cheese



96SKRLP
Parsley

CODE	LID COLOR	CASE KG (CUBE M³)
Shakers complete with lids (approx. capacity 300 mL)		
96SKRF (w/fine ground lid)	Green (407)	1,4 (0,009)
96SKRP (w/parsley lid)	White (148)	1,4 (0,009)
96SKRD (w/salt & pepper lid)	Beige (406)	1,4 (0,009)
96SKRC (w/cheese lid)	Yellow (405)	1,4 (0,009)
96SKRM (w/medium ground lid)	Rose (408)	1,4 (0,009)
Shaker Replacement Lids (Shaker Lids are not interchangeable with Camliter® Lids)		
96SKRLF fine ground lid	Green (407)	0,11 (0,001)
96SKRLP parsley lid	White (148)	0,51 (0,001)
96SKRLD salt & pepper lid	Beige (406)	0,13 (0,001)
96SKRLC cheese lid	Yellow (405)	0,12 (0,001)
96SKRLM medium ground lid	Rose (408)	0,12 (0,001)

Case Pack: 12

Camwear Polycarbonate Condiment Jars

- Use to hold condiments such as mustard, ketchup, dressings, jam or salsa.
- Made of clear, virtually unbreakable Camwear polycarbonate.
- Lids are slotted to hold serving spoons when not in use.

Color: Clear (135).

Personalization available. See crestring section for information, ordering and pricing.



CODE	APPROXIMATE CAPACITY	SIZE H x D	CASE PACK	CASE KG (CUBE M³)
Condiment Jar Set				
CJ80CW	240 mL	10,2 x 8,3 cm	24	0,37 (0,007)

SHELVING





Camshelving®



Easy and Quick to Clean



Easy to Adjust and Configure



Unquestionably Strong,
Durable and Stable



Rust Free

No Bolts,
No Nuts

CAMGUARD
ANTIMICROBIAL SHELF PLATES



Store and
Transport
Food Safely



Dishwasher Safe
Except mobile
parts.

HACCP



Fit for Food
Products



Cadmium-Free



Recyclable
Polypropylene

Consultant Cut Sheets and CAD
drawings are available on
www.cambro.com

Camshelving is covered by EU Patent #0686817 A2.

Easy And Quick To Clean

For A Sanitary Storage Area

- Shelf plates are easy to remove and run through the dishwasher.
- Smooth polypropylene surface quickly wipes clean.
- Spills clean quickly and easily, reducing the risk of cross-contamination.
- Camshelving® is weldless, so liquids and dirt cannot get inside crevices.

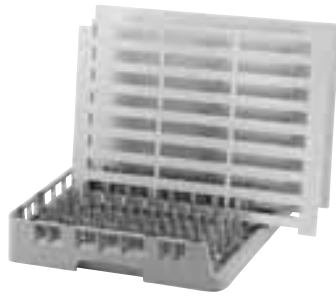

Shelf plates can be placed in an open end Camrack® OETR314 and washed in a commercial dishwasher.



- A silver-ion technology that inhibits the growth of mold, fungus and bacteria.
- Camguard works continuously to suppress the growth of microbes between cleanings.
- All shelf plates are embedded with Camguard antimicrobial so it will not scrape off, wash off or wear out.



Strong And Durable

Strong As Steel

- Posts and traverses are the weight bearing components, constructed with a steel core and encapsulated by a thick polypropylene outer layer.
- Inner steel core ensures that Camshelving is strong, durable and stable.
- Thick, polypropylene outer layer will not chip, break or corrode.
- Post connectors provide exceptional cross stabilization.



Weight bearing components are made with a steel core.

Weight Bearing Capacity

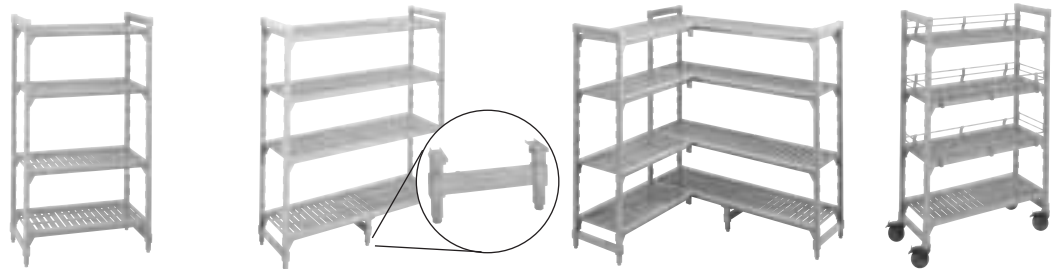

	SINGLE UNIT - 4 SHELVES	SINGLE UNIT - 4 SHELVES	DUNNAGE STAND	CORNER UNIT	MOBILE UNIT
TRAVERSE LENGTH	610 to 1220 mm	1370 to 1830 mm	1300 to 1830 mm	610 to 1220 mm	610 to 1220 mm
WEIGHT BEARING CAPACITY PER SHELF	363 Kg	272 Kg	454 Kg	181 Kg	—
WEIGHT BEARING CAPACITY PER UNIT WITH 4 SHELVES	1451 Kg	1089 Kg	—	726 Kg	340 Kg

Dunnage Stands are used only on the bottom shelf. Recommended for traverses 1370 mm or longer.

Corner Connectors are recommended for use on traverses 1220 mm or less.

Due to the weight bearing capacity of casters, maximum weight load on an entire Mobile Camshelving Unit is 340 Kg.

Easy To Assemble & Adjust

Build Any Configuration and Fit Any Size Area

- Create a space efficient layout for any area.
- Assembles in minutes, requiring only the use of a mallet.
- Shelves can be adjusted in 100 mm increments without disassembling the entire unit.
- Two units can be connected together with shelves at alternating heights for maximum storage flexibility.
- Corner Connectors attach units to create a 90° angle or U shape.

POST HEIGHT	DOVETAIL INCREMENT	NUMBER OF POSITIONS PER POST
Stationary		
820 mm	100 mm	6
1430 mm	100 mm	12
1630 mm	100 mm	14
1830 mm	100 mm	16
2140 mm	100 mm	19
Mobile		
890 mm	100 mm	6
1500 mm	100 mm	12
1700 mm	100 mm	14
1910 mm	100 mm	16

Rust Free

For Use in Any Area, Wet or Dry

- Camshelving is weldless with no exposed metal, so it remains rust free.
- Safe to -38°C, making Camshelving the ideal shelving system for freezers, walk-ins or any wet or humid environment.
- Not even salt water or sea air will corrode Camshelving.



Lifetime limited warranty against rust and corrosion for traverses and stationary posts.

HACCP

EASY TO ADJUST!

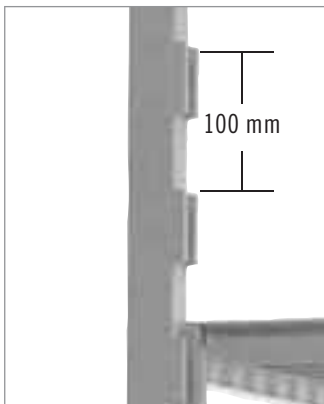

Shelves can be adjusted in 100 mm increments, without disassembling the unit.

EASY TO ASSEMBLE!

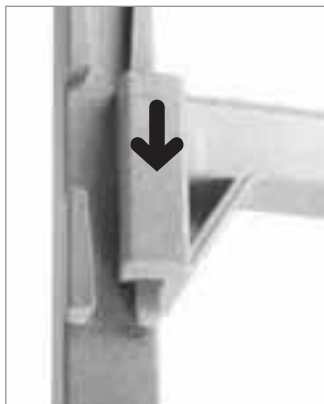

Traverses slide easily down onto dovetail.



Dry Storage Room



Cold Storage Room

Camshelving® Consulting & Wall shelf Kits



Free Camshelving Consulting Service

Cambro provides a free consulting service using our proprietary computer program. To contact the Camshelving Consulting Department, just call Cambro at 1 (714) 230-4113 or fax to 1 (714) 230-4199 or e-mail to mperez@cambro.com. Provide the dimensions of the storage space,

number of shelves per unit, height of the posts and any other special requirements you have. Cambro will provide a recommended floor plan and product order list. Your Cambro Distributor or Sales Representative will contact you with pricing. There is no cost or obligation to use the Cambro Consulting Service.

Components

Camshelving is a modular system that allows the flexibility to assemble shelving to fit any size area. The key components, including posts, post connectors, traverses and shelf plates, are available in a variety of sizes.

They can be easily configured to custom build shelving to maximize storage space. Unique design elements such as shared posts and corner connectors simplify assembly and increase storage capacity.

Traverses

Traverses have a steel core with a polypropylene exterior to provide strength and durability.

Traverses connect to the post by sliding on to the dovetail on the post.

Two traverses are needed to build one shelf, and they define the length of the unit.

Shelf Plates

Shelf Plates are made of polypropylene. Dishwasher safe.

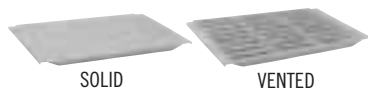

Shelf Kit
Includes two Traverses and Shelf Plates to fit the length of the Traverses

SOLID VENTED

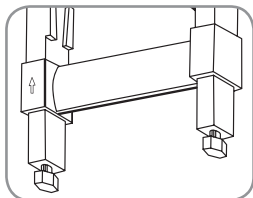

Posts For Stationary Unit

Posts have a steel core with a polypropylene exterior to provide strength and durability.

Posts define the height of the shelving unit and are measured with the leveling foot fully engaged.

Post for Stationary unit



Post Connectors

Post connectors hold two posts together and define the width of the unit.

They are made of polypropylene and provide excellent cross stabilization.

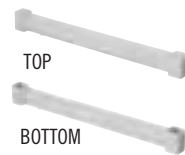

POST KIT
Includes two Posts and a set of one top and one bottom Post Connector

Posts for Mobile Camshelving

Mobile Camshelving posts must be used to build mobile Camshelving units.



Casters

Available in standard for dry storage or premium for freezers, cold, or wet applications.



Maximize Space Utilization

Camshelving is available in starter and add-on units for ease of ordering and assembly.

Starter Units

- Available in stationary or mobile units.
- Starter units ship complete with two post kits, traverses and shelf plates to build an entire unit.

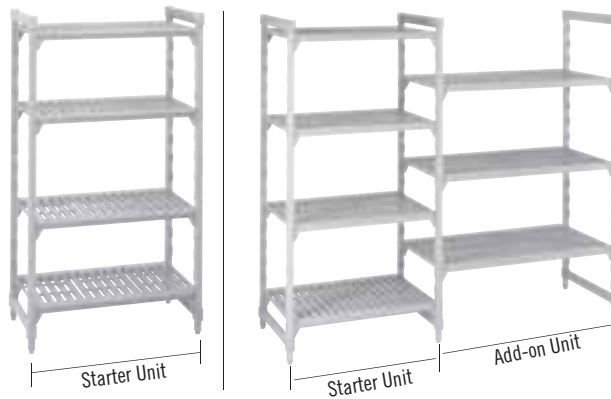

Add-On Units

- Add-On units ship complete with one post kit, traverses and shelf plates to attach to an adjoining unit.
- The traverses on both the first and second unit share the middle post.
- No add-on clips or S-hooks required.
- There is no loss of weight bearing capacity when built in a straight line.



Corner Unit & U Shape Units

- Corner connectors can be used to build corner units and U Shape units.
- Traverses snap onto corner connectors just like they snap onto the dovetails of the posts.

Corner Connector Set

- Attaches a basic unit to a second unit at a 90° angle or to form a U shape.
- A set of corner connectors are needed for each shelf.

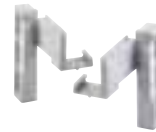

* Corner connectors are recommended for use on traverses equal to or shorter than 1220 mm, and covered by U.S. Patent D498,664S.

Dunnage Stand

- Increases weight bearing capacity to 454 kg on the bottom shelf.
- Recommended for units 1380 mm or longer.



* Dunnage stands are covered by U.S. Patent US 6,981,454B2.

Fence System

- Prevents stored items from falling off shelving units.
- Ideal for mobile shelving.

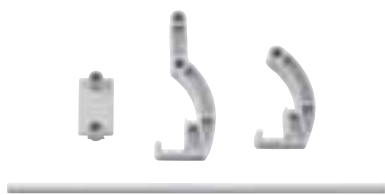

Mobile Units

- Mobile Camshelving units are built by using posts for mobile carts and inserting casters.
- Mobile units are not designed to serve as transport carts.



Mobile unit shown with optional fencing.

Seismic Foot

- Bolts a post to the floor for a more stable base.
- Screws not included.



Wall Fastener

- Fastens a unit to a wall as a safety precaution.
- Screws not included.



Identification Tag

- Easily clips onto traverses to identify stored items.
- Made of PVC.
- Includes 12 HACCP labels.



Donut Bumper

- Protects mobile Camshelving.
- 90 mm Bumper.

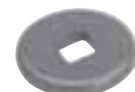

Camshelving® Footprint Dimensions

- The following charts are provided to assist in developing a footprint for your storage area.
- They can also be used to help determine your actual shelf space.
- Traverse measurements are based on outside, or overall unit length.
- This includes the posts.
- The overall length varies slightly when using a basic unit, add-on unit, intermediate unit or corner unit.
- These variations are outlined below.

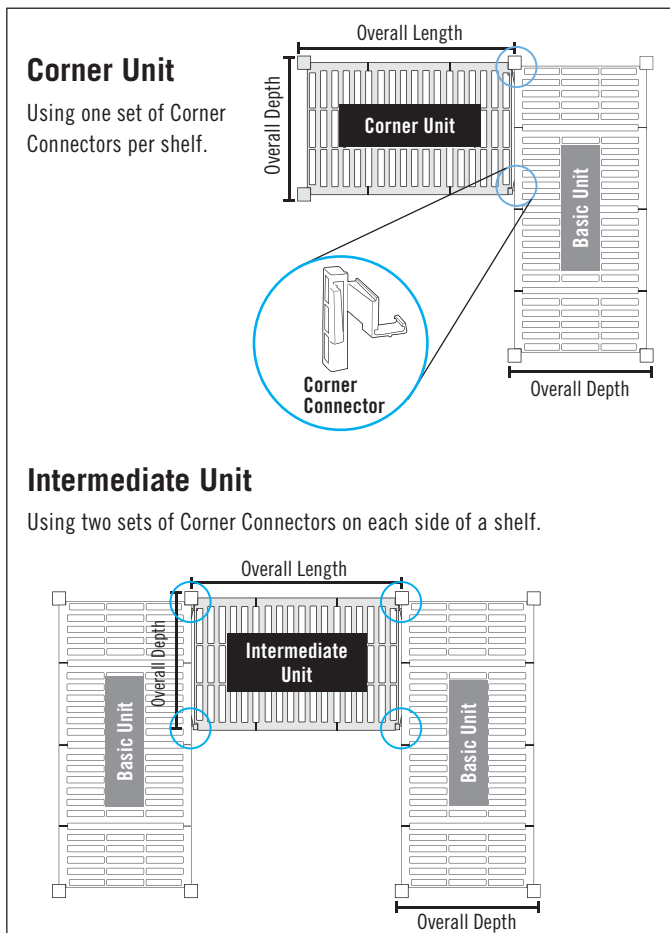
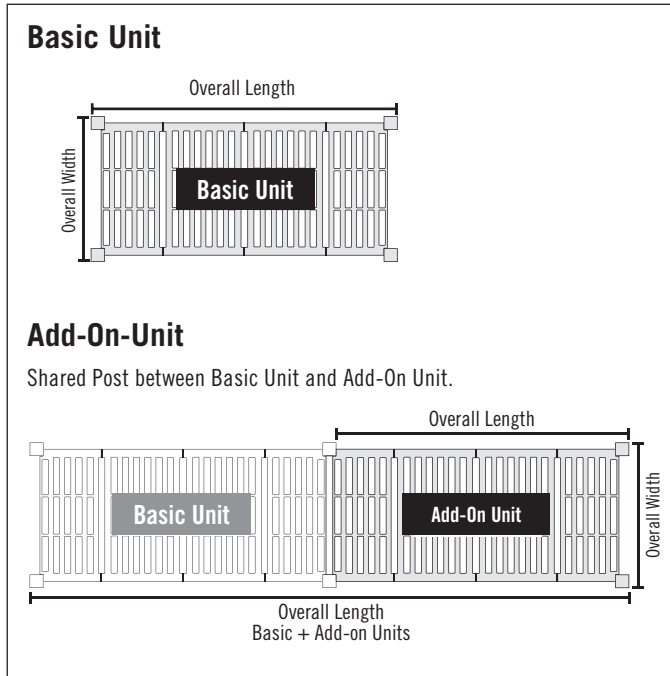

UNIT	BASIC UNIT OVERALL LENGTH	ADD-ON UNIT OVERALL LENGTH	BASIC + ADD-ON UNIT OVERALL LENGTH
610 mm	610 mm	565 mm	1175 mm
760 mm	760 mm	720 mm	1480 mm
910 mm	910 mm	870 mm	1780 mm
1070 mm	1070 mm	1025 mm	2095 mm
1220 mm	1220 mm	1175 mm	2395 mm
1380 mm	1380 mm	1330 mm	2710 mm
1530 mm	1530 mm	1480 mm	3010 mm
1830 mm	1830 mm	1790 mm	3620 mm

UNIT	CORNER UNIT OVERALL LENGTH	INTERMEDIATE UNIT OVERALL LENGTH
610 mm	585 mm	560 mm
760 mm	740 mm	715 mm
910 mm	890 mm	865 mm
1070 mm	1045 mm	1020 mm
1220 mm	1195 mm	1170 mm

Corner Connectors are recommended for use on traverses 1220 mm or less.

Shelf Spacing

Dovetails are spaced every 100 mm



POST HEIGHT	DOVETAIL INCREMENT	NUMBER OF POSITIONS PER POST
Stationary		
820 mm	100 mm	6
1430 mm	100 mm	12
1630 mm	100 mm	14
1830 mm	100 mm	16
2140 mm	100 mm	19
Mobile		
890 mm	100 mm	6
1500 mm	100 mm	12
1700 mm	100 mm	14
1910 mm	100 mm	16



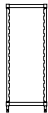
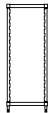
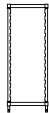





Stationary Post Kits

					
HEIGHT	WIDTH	360 mm	460 mm	540 mm	610 mm
820 mm	CODE	CSPK1432	CSPK1832	CSPK2132	CSPK2432
	CASE KG/CUBE M ³	2,27 (0,009)	2,45 (0,009)	2,59 (0,009)	2,82 (0,009)
1430 mm	CODE	CSPK1456	CSPK1856	CSPK2156	CSPK2456
	CASE KG/CUBE M ³	6,10 (0,0135)	6,26 (0,0135)	6,40 (0,0135)	6,58 (0,0135)
1630 mm	CODE	CSPK1464	CSPK1864	CSPK2164	CSPK2464
	CASE KG/CUBE M ³	7,0 (0,0155)	6,9 (0,012)	7,18 (0,013)	7,48 (0,0155)
1830 mm	CODE	CSPK1472	CSPK1872	CSPK2172	CSPK2472
	CASE KG/CUBE M ³	7,80 (0,0164)	7,73 (0,013)	7,8 (0,015)	8,28 (0,0164)
2140 mm	CODE	CSPK1484	CSPK1884	CSPK2184	CSPK2484
	CASE KG/CUBE M ³	9,05 (0,0192)	8,6 (0,016)	8,71 (0,015)	8,94 (0,015)

Case Pack: 1

Color: Speckled Gray (480).









Solid Shelf Kits

									
WIDTH	LENGTH	610 mm	760 mm	910 mm	1070 mm	1220 mm	1380 mm	1530 mm	1830 mm
360 mm	CODE	CS1424SK	CS1430SK	CS1436SK	CS1442SK	CS1448SK	CS1454SK	CS1460SK	CS1472SK
	CASE KG/CUBE M ³	3,53 (0,0235)	4,36 (0,0235)	5,19 (0,0235)	6,03 (0,0274)	6,85 (0,0300)	7,43 (0,046)	18,30 (0,0390)	10,07 (0,0470)
460 mm	CODE	CS1824SK	CS1830SK	CS1836SK	CS1842SK	CS1848SK	CS1854SK	CS1860SK	CS1872SK
	CASE KG/CUBE M ³	3,36 (0,025)	4,22 (0,0235)	5,47 (0,0235)	6,53 (0,0274)	7,16 (0,0300)	8,22 (0,0351)	9,05 (0,0390)	10,84 (0,0470)
540 mm	CODE	CS2124SK	CS2130SK	CS2136SK	CS2142SK	CS2148SK	CS2154SK	CS2160SK	CS2172SK
	CASE KG/CUBE M ³	4,14 (0,0235)	5,12 (0,0235)	5,36 (0,037)	6,65 (0,046)	8,03 (0,0300)	8,45 (0,048)	9,33 (0,053)	11,15 (0,065)
610 mm	CODE	CS2424SK	CS2430SK	CS2436SK	CS2442SK	CS2448SK	CS2454SK	CS2460SK	CS2472SK
	CASE KG/CUBE M ³	4,20 (0,0235)	5,27 (0,0235)	6,33 (0,0235)	7,12 (0,046)	7,88 (0,037)	9,56 (0,0351)	10,41 (0,039)	12,65 (0,0470)

Case Pack: 1

Color: Speckled Gray (480).

Vented Shelf Kits





									
WIDTH	LENGTH	610 mm	760 mm	910 mm	1070 mm	1220 mm	1380 mm	1530 mm	1830 mm
360 mm	CODE	CS1424VK	CS1430VK	CS1436VK	CS1442VK	CS1448VK	CS1454VK	CS1460VK	CS1472VK
	CASE KG/CUBE M ³	2,99 (0,025)	4,15 (0,0235)	4,43 (0,037)	5,23 (0,045)	6,51 (0,0300)	7,31 (0,0351)	7,29 (0,053)	8,90 (0,065)
460 mm	CODE	CS1824VK	CS1830VK	CS1836VK	CS1842VK	CS1848VK	CS1854VK	CS1860VK	CS1872VK
	CASE KG/CUBE M ³	3,60 (0,0235)	2,43 (0,0235)	5,19 (0,0235)	5,82 (0,045)	6,78 (0,0300)	7,16 (0,044)	8,53 (0,0390)	9,66 (0,066)
540 mm	CODE	CS2124VK	CS2130VK	CS2136VK	CS2142VK	CS2148VK	CS2154VK	CS2160VK	CS2172VK
	CASE KG/CUBE M ³	3,93 (0,0235)	2,84 (0,0235)	5,33 (0,029)	6,34 (0,035)	6,88 (0,038)	8,73 (0,0351)	8,95 (0,053)	11,58 (0,0470)
610 mm	CODE	CS2424VK	CS2430VK	CS2436VK	CS2442VK	CS2448VK	CS2454VK	CS2460VK	CS2472VK
	CASE KG/CUBE M ³	3,72 (0,025)	3,06 (0,026)	5,65 (0,037)	6,94 (0,0274)	7,94 (0,0300)	8,56 (0,049)	9,67 (0,0390)	11,77 (0,0470)

Case Pack: 1

Color: Speckled Gray (480).

www.cambro.com

Vented Starter Units





WIDTH 460 mm		 *	 *	 *	 *	 *
HEIGHT	LENGTH	910 mm	1070 mm	1220 mm	1380 mm	1530 mm
1630 mm	CODE - 4 SHELVES	CSU48366	CSU48426	CSU48486	CSU48546	CSU48606
	CASE KG/CUBE M ³	35,09 (0,150)	39,04 (0,150)	38,28 (0,16)	46,00 (0,1506)	44,27 (0,158)
1630 mm	CODE - 5 SHELVES	CSU58366	CSU58426	CSU58486	CSU58546	CSU58606
	CASE KG/CUBE M ³	40,28 (0,150)	45,22 (0,150)	48,21 (0,1506)	53,16 (0,1506)	51,53 (0,1506)
1830 mm	CODE - 4 SHELVES	CSU48367	CSU48427	CSU48487	CSU48547	CSU48607
	CASE KG/CUBE M ³	35,38 (0,160)	37,50 (0,157)	40,52 (0,161)	47,00 (0,1506)	45,66 (0,163)
1830 mm	CODE - 5 SHELVES	CSU58367	CSU58427	CSU58487	CSU58547	CSU58607
	CASE KG/CUBE M ³	42,73 (0,170)	49,17 (0,1506)	55,00 (0,1506)	53,07 (0,1506)	

Case Pack: 1

Color: Speckled Gray (480).

* Dimensions provided with line drawings above are actual dimensions.

Vented Add-On Units





WIDTH 460 mm		 *	 *	 *	 *	 *
HEIGHT	LENGTH	910 mm	1070 mm	1220 mm	1380 mm	1530 mm
1630 mm	CODE - 4 SHELVES	CSA48366	CSA48426	CSA48486	CSA48546	CSA48606
	CASE KG/CUBE M ³	27,92 (0,1506)	31,88 (0,1506)	34,27 (0,1506)	38,50 (0,1506)	41,28 (0,1506)
1630 mm	CODE - 5 SHELVES	CSA58366	CSA58426	CSA58486	CSA58546	CSA58606
	CASE KG/CUBE M ³	33,11 (0,1506)	38,06 (0,1506)	37,92 (0,167)	46,00 (0,1506)	49,80 (0,1506)
1830 mm	CODE - 4 SHELVES	CSA48367	CSA48427	CSA48487	CSA48547	CSA48607
	CASE KG/CUBE M ³	28,08 (0,1506)	32,04 (0,1506)	34,43 (0,1506)	39,00 (0,1506)	41,44 (0,1506)
1830 mm	CODE - 5 SHELVES	CSA58367	CSA58427	CSA58487	CSA58547	CSA58607
	CASE KG/CUBE M ³	33,27 (0,1506)	38,21 (0,1506)	41,21 (0,1506)	47,00 (0,1506)	45,54 (0,168)

Case Pack: 1

Color: Speckled Gray (480).

* Dimensions provided with line drawings above are actual dimensions.

Vented Starter Units





WIDTH 540 mm		 *	 *	 *	 *	 *
HEIGHT	LENGTH	910 mm	1070 mm	1220 mm	1380 mm	1530 mm
1630 mm	CODE - 4 SHELVES	CSU41366	CSU41426	CSU41486	CSU41546	CSU41606
	CASE KG/CUBE M ³	37,61 (0,200)	42,24 (0,200)	41,73 (0,205)	49,53 (0,2007)	47,81 (0,205)
1630 mm	CODE - 5 SHELVES	CSU51366	CSU51426	CSU51486	CSU51546	CSU51606
	CASE KG/CUBE M ³	40,28 (0,200)	44,36 (0,203)	47,63 (0,203)	54,44 (0,203)	62,82 (0,2007)
1830 mm	CODE - 4 SHELVES	CSU41367	CSU41427	CSU41487	CSU41547	CSU41607
	CASE KG/CUBE M ³	41,73 (0,200)	43,83 (0,200)	46,48 (0,2007)	46,54 (0,206)	46,41 (0,199)
1830 mm	CODE - 5 SHELVES	CSU51367	CSU51427	CSU51487	CSU51547	CSU51607
	CASE KG/CUBE M ³	44,95 (0,200)	45,08 (0,209)	54,05 (0,2007)	53,52 (0,2007)	57,52 (0,2007)

Case Pack: 1

Color: Speckled Gray (480).

* Dimensions provided with line drawings above are actual dimensions.

Vented Add-On Units





WIDTH 540 mm		 *	 *	 *	 *	 *
HEIGHT	LENGTH	910 mm	1070 mm	1220 mm	1380 mm	1530 mm
1630 mm	CODE - 4 SHELVES	CSA41366	CSA41426	CSA41486	CSA41546	CSA41606
	CASE KG/CUBE M ³	30,31 (0,2007)	34,94 (0,2007)	37,59 (0,2007)	42,23 (0,2007)	45,88 (0,2007)
1630 mm	CODE - 5 SHELVES	CSA51366	CSA51426	CSA51486	CSA51546	CSA51606
	CASE KG/CUBE M ³	36,06 (0,2007)	41,84 (0,2007)	41,64 (0,203)	45,54 (0,203)	49,9 (0,203)
1830 mm	CODE - 4 SHELVES	CSA41367	CSA41427	CSA41487	CSA41547	CSA41607
	CASE KG/CUBE M ³	31,10 (0,2007)	35,73 (0,2007)	38,38 (0,2007)	43,02 (0,2007)	39,4 (0,213)
1830 mm	CODE - 5 SHELVES	CSA51367	CSA51427	CSA51487	CSA51547	CSA51607
	CASE KG/CUBE M ³	36,86 (0,2007)	42,64 (0,2007)	45,95 (0,2007)	51,76 (0,2007)	56,31 (0,2007)

Case Pack: 1

Color: Speckled Gray (480).

* Dimensions provided with line drawings above are actual dimensions.

Vented Starter Units

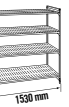



WIDTH 610 mm		 *	 *	 *	 *	 *
HEIGHT	LENGTH	915 mm	1070 mm	1220 mm	1380 mm	1530 mm
1630 mm	CODE - 4 SHELVES	CSU44366	CSU44426	CSU44486	CSU44546	CSU44606
	CASE KG/CUBE M ³	37,38 (0,237)	42,75 (0,200)	46,72 (0,2007)	51,00 (0,2007)	51,17 (0,226)
1630 mm	CODE - 5 SHELVES	CSU54366	CSU54426	CSU54486	CSU54546	CSU54606
	CASE KG/CUBE M ³	44,70 (0,200)	49,69 (0,200)	54,66 (0,2007)	60,00 (0,2007)	63,32 (0,2007)
1830 mm	CODE - 4 SHELVES	CSU44367	CSU44427	CSU44487	CSU44547	CSU44607
	CASE KG/CUBE M ³	39,01 (0,228)	42,18 (0,232)	45,81 (0,223)	52,50 (0,2007)	53,07 (0,234)
1830 mm	CODE - 5 SHELVES	CSU54367	CSU54427	CSU54487	CSU54547	CSU54607
	CASE KG/CUBE M ³	44,09 (0,23)	51,28 (0,200)	52,84 (0,231)	62,50 (0,2007)	60,24 (0,229)

Case Pack: 1

Color: Speckled Gray (480).

* Dimensions provided with line drawings above are actual dimensions.

Vented Add-On Units

WIDTH 610 mm		 *	 *	 *	 *	 *
HEIGHT	LENGTH	915 mm	1070 mm	1220 mm	1380 mm	1530 mm
1630 mm	CODE - 4 SHELVES	CSA44366	CSA44426	CSA44486	CSA44546	CSA44606
	CASE KG/CUBE M ³	30,9 (0,206)	35,26 (0,2007)	38,03 (0,029)	43,50 (0,2007)	46,17 (0,2007)
1630 mm	CODE - 5 SHELVES	CSA54366	CSA54426	CSA54486	CSA54546	CSA54606
	CASE KG/CUBE M ³	35,74 (0,229)	42,21 (0,2007)	47,17 (0,2007)	52,50 (0,2007)	55,84 (0,2007)
1830 mm	CODE - 4 SHELVES	CSA44367	CSA44427	CSA44487	CSA44547	CSA44607
	CASE KG/CUBE M ³	32,06 (0,2007)	36,06 (0,2007)	39,31 (0,232)	44,00 (0,2007)	45,36 (0,240)
1830 mm	CODE - 5 SHELVES	CSA54367	CSA54427	CSA54487	CSA54547	CSA54607
	CASE KG/CUBE M ³	38,01 (0,2007)	43,0 (0,2007)	47,97 (0,2007)	53,00 (0,2007)	56,63 (0,2007)





Case Pack: 1

Color: Speckled Gray (480).

* Dimensions provided with line drawings above are actual dimensions.

Vented Starter Units





Due to heavy weight of 2140 mm shelving, starter and add-on units will be shipped in two separate cartons.

WIDTH 610 mm						
HEIGHT	LENGTH	910 mm	1070 mm	1220 mm	1380 mm	1530 mm
2140 mm	CODE - 5 SHELVES	CSU54368PKG	CSU54428PKG	CSU54488PKG	CSU54548PKG	CSU54608PKG
	POST KIT BOX	Set of 2 post kits	Set of 2 post kits	Set of 2 post kits	Set of 2 post kits	Set of 2 post kits
	CASE KG (CUBE M ³)	18,51 (0,032)	18,51 (0,032)	18,51 (0,032)	18,51 (0,032)	18,51 (0,032)
	SHELF KIT BOX	Set of 5 shelf kits	Set of 5 shelf kits	Set of 5 shelf kits	Set of 5 shelf kits	Set of 5 shelf kits
	CASE KG (CUBE M ³)	27,49 (0,186)	33,11 (0,2221)	36,29 (0,193)	41,37 (0,238)	46,08 (0,265)

Case Pack: 1.



Color: Speckled Gray (480). Dimensions provided with line drawings above are actual dimensions.



Vented Add-on Units

WIDTH 610 mm						
HEIGHT	LENGTH	910 mm	1070 mm	1220 mm	1380 mm	1530 mm
2140 mm	CODE - 5 SHELVES	CSA54368PKG	CSA54428PKG	CSA54488PKG	CSA54548PKG	CSA54608PKG
	POST KIT BOX	Set of 1 post kit	Set of 1 post kit	Set of 1 post kit	Set of 1 post kit	Set of 1 post kit
	CASE KG (CUBE M ³)	9,52 (0,0173)	9,52 (0,0173)	9,52 (0,0173)	9,52 (0,0173)	9,52 (0,0173)
	SHELF KIT BOX	Set of 5 shelf kits	Set of 5 shelf kits	Set of 5 shelf kits	Set of 5 shelf kits	Set of 5 shelf kits
	CASE KG (CUBE M ³)	27,49 (0,186)	33,11 (0,2221)	36,29 (0,193)	41,37 (0,238)	46,08 (0,265)

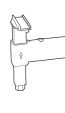
Case Pack: 1.

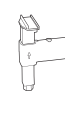
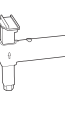
Color: Speckled Gray (480). Dimensions provided with line drawings above are actual dimensions.



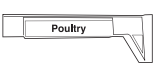
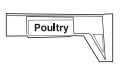

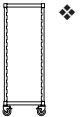
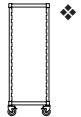
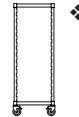

Dunnage Stands					
HEIGHT	WIDTH	360 mm	460 mm	540 mm	610 mm
165 mm	CODE	CSDS14	CSDS18	CSDS21	CSDS24
	CASE KG (CUBE M ³)	1,20 (0,005)	1,30 (0,006)	1,40 (0,007)	1,50 (0,008)

Accessories						
		Seismic Foot	Wall Fastener	Corner Connectors	Id Tag	Id Tag
	CODE	CSEQ3	CSWF	CSCC	CSID	CSID3
	DESCRIPTION	Seismic Foot	Wall Fastener	90° Left & Right	150 mm ID Tag	80 mm ID Tag
	COLOR	Silver	Silver	Speckled Gray (480)	White/Clear	White/Clear
	SIZE/ L x W x H	100 x 85 x 60 mm	238 x 48 x 73 mm	—	25 x 150 mm	25 x 80 mm
	CASE KG (CUBE M ³)	0,649 (0,001)	1,85 (0,006)	-	0,372 (0,0023)	0,263 (0,0017)
	CASE PACK	4 each	4 each	1 set of 2 parts	12 each	12 each

Mobile Post Kits & Casters

				
HEIGHT WITH CASTERS	WIDTH	460 mm	540 mm	610 mm
890 mm	CODE	CSPRK1835	CSPRK2135	CSPRK2435
	CASE KG/CUBE M ³	3,99 (0,0074)	4,13 (0,0074)	4,31 (0,0074)
1500 mm	CODE	CSPRK1859	CSPRK2159	CSPRK2459
	CASE KG/CUBE M ³	6,26 (0,0135)	6,40 (0,0135)	6,58 (0,0135)
1700 mm	CODE	CSPRK1867	CSPRK2167	CSPRK2467
	CASE KG/CUBE M ³	6,62 (0,012)	7,30 (0,0155)	7,48 (0,0155)
1910 mm	CODE	CSPRK1875	CSPRK2175	CSPRK2475
	CASE KG/CUBE M ³	7,96 (0,0164)	8,10 (0,0164)	7,86 (0,013)

Case Pack: 1 Color: Speckled Gray (480).  Casters are not included and must be ordered separately.



		Premium	Premium	Standard	Standard	Standard	Donut Bumper
CASTERS							
	DIAMETER	127 mm	127 mm	127 mm	127 mm	127 mm	90 mm
	CODE	CSCSL	CSCTL	CSSB	CSCS	CSCR	CSRDB
	DESCRIPTION	Swivel with lock in one direction	Total Locking Caster	Swivel Chrome with Brake	Swivel Chrome Caster	Rigid Chrome Caster	Donut Bumper

Caster Case Pack: 2. Donut Bumper Case Pack: 4.

Premium Casters: The Premium line is made with a zinc plated post and a non-marking polyurethane wheel. Recommended for use in wet areas or in walk-in refrigerators and freezers.

Standard Casters: The Standard Casters are chrome plated and can be used for dry storage.







Fence System For Camshelving®

PRODUCT	FITS Traverse	610 mm	760 mm	910 mm	1070 mm	1220 mm	1380 mm	1530 mm	1830 mm
 100 mm	CODE	CSFT242	CSFT302	CSFT362	CSFT422	CSFT482	CSFT542	CSFT602	CSFT722
	# OF BRACKETS	2	2	2	3	4	4	4	5
	# OF RODS	2	2	2	2	2	2	2	2v
	CASE KG/CUBE M ³	3,53 (0,0235)	4,36 (0,0235)	5,19 (0,0235)	6,03 (0,0274)	6,85 (0,0300)	7,68 (0,035)	18,30 (0,0390)	10,07 (0,0470)
 50 mm	CODE	CSFT241	CSFT301	CSFT361	CSFT421	CSFT481	CSFT541	CSFT601	CSFT721
	# OF BRACKETS	2	2	2	3	3	4	4	5
	# OF RODS	1	1	1	1	1	1	1	1
	CASE KG/CUBE M ³	3,78 (0,0235)	4,63 (0,0235)	5,47 (0,0235)	6,53 (0,0274)	7,16 (0,0300)	8,22 (0,0351)	9,05 (0,0390)	10,84 (0,0470)

PRODUCT	FITS Post Connector	360 mm	460 mm	540 mm	610 mm
	CODE	CSFE14	CSFE18	CSFE21	CSFE24
	# OF BRACKETS	2	2	2	2
	# OF RODS	2	2	2	2
	CASE KG/CUBE M ³	3,53 (0,0235)	4,36 (0,0235)	5,19 (0,0235)	0,345 (0,002)

Case Pack: 1 Color: Speckled Gray (480).

Vented Mobile Starter Units







		Premium*	Standard**	Premium*	Standard**	Premium*	Standard**
DEPTH 460 mm							
HEIGHT WITH CASTERS	LENGTH	910 mm	910 mm	1070 mm	1070 mm	1220 mm	1220 mm
1700 mm	CODE - 4 SHELVES	CSUR48366	CSURS48366	CSUR48426	CSURS48426	CSUR48486	CSURS48486
	CASE KG/CUBE M ³	35,74 (0,17)	39,63 (0,173)	39,64 (0,17)	43,58 (0,173)	45,98 (0,173)	45,98 (0,173)
1700 mm	CODE - 5 SHELVES	CSUR58366	CSURS58366	CSUR58426	CSURS58426	CSUR58486	CSURS58486
	CASE KG/CUBE M ³	40,37 (0,17)	44,82 (0,173)	49,76 (0,173)	49,76 (0,173)	52,75 (0,173)	52,75 (0,173)
1910 mm	CODE - 4 SHELVES	CSUR48367	CSURS48367	CSUR48427	CSURS48427	CSUR48487	CSURS48487
	CASE KG/CUBE M ³	35,74 (0,17)	39,63 (0,173)	39,64 (0,17)	43,58 (0,173)	45,98 (0,173)	45,98 (0,173)
1910 mm	CODE - 5 SHELVES	CSUR58367	CSURS58367	CSUR58427	CSURS58427	CSUR58487	CSURS58487
	CASE KG/CUBE M ³	40,37 (0,17)	44,82 (0,173)	49,76 (0,173)	49,76 (0,173)	52,75 (0,173)	52,75 (0,173)

Case Pack: 1

Color: Speckled Gray (480).

*Premium Casters: include two non-corrosive Swivel Locking Casters (CSCSL) and two Total Locking Casters (CSCTL).

**Standard Casters: include two Swivel Chrome Casters (CSCS) and two Swivel Chrome with Brakes (CSSB).







		Premium*	Standard**	Premium*	Standard**	Premium*	Standard**
DEPTH 540 mm							
HEIGHT WITH CASTERS	LENGTH	910 mm	910 mm	1070 mm	1070 mm	1220 mm	1220 mm
1700 mm	CODE - 4 SHELVES	CSUR41366	CSURS41366	CSUR41426	CSURS41426	CSUR41486	CSURS41486
	CASE KG/CUBE M ³	43,29 (0,227)	38,83 (0,209)	47,28 (0,227)	47,28 (0,227)	51,26 (0,227)	51,26 (0,227)
1700 mm	CODE - 5 SHELVES	CSUR51366	CSURS51366	CSUR51426	CSURS51426	CSUR51486	CSURS51486
	CASE KG/CUBE M ³	49,24 (0,227)	49,24 (0,227)	47,17 (0,203)	54,23 (0,227)	59,19 (0,227)	59,19 (0,227)
1910 mm	CODE - 4 SHELVES	CSUR41367	CSURS41367	CSUR41427	CSURS41427	CSUR41487	CSURS41487
	CASE KG/CUBE M ³	44,88 (0,227)	39,64 (0,214)	42,46 (0,201)	43,91 (0,213)	52,84 (0,227)	52,84 (0,227)
1910 mm	CODE - 5 SHELVES	CSUR51367	CSURS51367	CSUR51427	CSURS51427	CSUR51487	CSURS51487
	CASE KG/CUBE M ³	50,83 (0,227)	50,83 (0,227)	55,82 (0,227)	48,81 (0,203)	60,78 (0,227)	60,78 (0,227)

Case Pack: 1

Color: Speckled Gray (480).

*Premium Casters: include two non-corrosive Swivel Locking Casters (CSCSL) and two Total Locking Casters (CSCTL).

**Standard Casters: include two Swivel Chrome Casters (CSCS) and two Swivel Chrome with Brakes (CSSB).

		Premium*	Standard**	Premium*	Standard**	Premium*	Standard**
DEPTH 610 mm							
HEIGHT WITH CASTERS	LENGTH	910 mm	910 mm	1070 mm	1070 mm	1220 mm	1220 mm
1700 mm	CODE - 4 SHELVES	CSUR44366	CSURS44366	CSUR44426	CSURS44426	CSUR44486	CSURS44486
	CASE KG/CUBE M ³	43,29 (0,227)	41,1 (0,241)	47,28 (0,227)	44,54 (0,227)	51,26 (0,227)	49,53 (0,234)
1700 mm	CODE - 5 SHELVES	CSUR54366	CSURS54366	CSUR54426	CSURS54426	CSUR54486	CSURS54486
	CASE KG/CUBE M ³	49,24 (0,227)	49,24 (0,227)	54,23 (0,227)	50,44 (0,247)	59,19 (0,227)	59,19 (0,227)
1910 mm	CODE - 4 SHELVES	CSUR44367	CSURS44367	CSUR44427	CSURS44427	CSUR44487	CSURS44487
	CASE KG/CUBE M ³	44,88 (0,227)	40,1 (0,233)	48,87 (0,227)	48,87 (0,227)	48,99 (0,231)	52,84 (0,227)
1910 mm	CODE - 5 SHELVES	CSUR54367	CSURS54367	CSUR54427	CSURS54427	CSUR54487	CSURS54487
	CASE KG/CUBE M ³	50,83 (0,227)	47,08 (0,241)	55,82 (0,227)	51,89 (0,237)	60,78 (0,227)	60,78 (0,227)

Case Pack: 1

Color: Speckled Gray (480).

*Premium Casters: include two non-corrosive Swivel Locking Casters (CSCSL) and two Total Locking Casters (CSCTL).

**Standard Casters: include two Swivel Chrome Casters (CSCS) and two Swivel Chrome with Brakes (CSSB).

Camshelving® High Density Storage System

High Density Camshelving maximizes storage capacity by eliminating aisles and utilizing all available space. Ideal for operations with limited space or that need to use their space more effectively. Floor track system provides safe and easy access to stored product. Heavy weight loads roll securely on raised floor track.



COMPONENTES

Increases Storage Capacity up to

40%

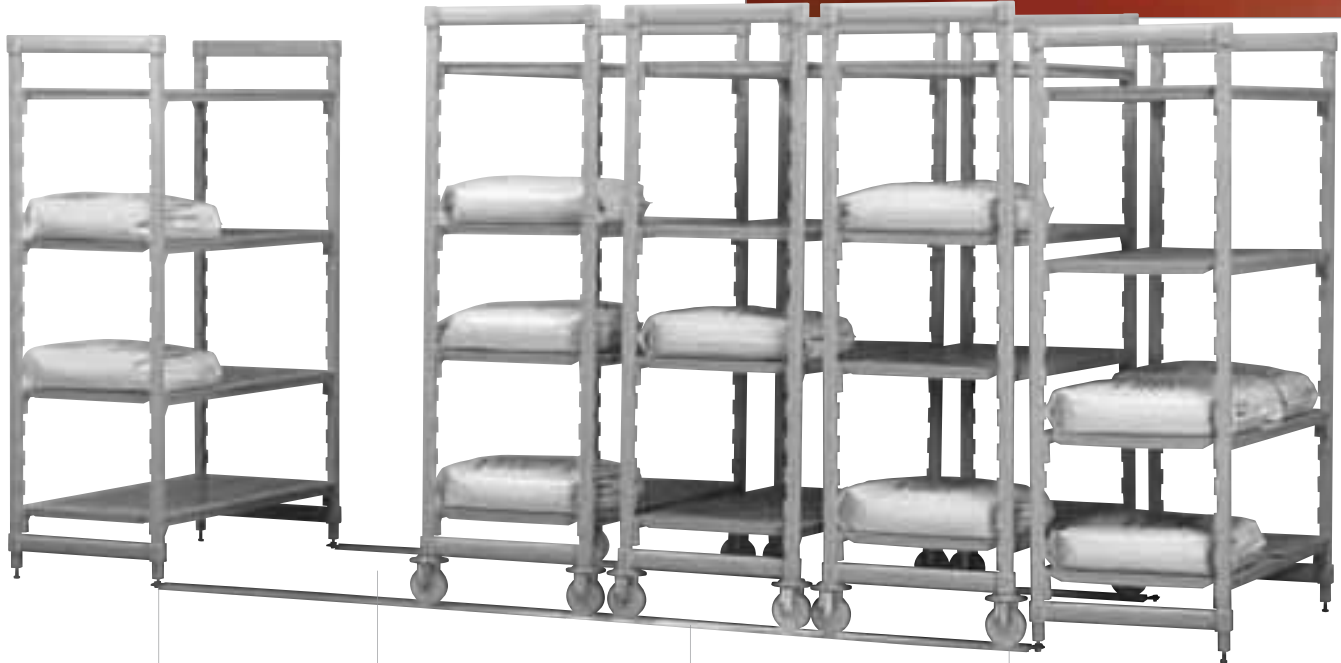

Easy Glide Floor Tracks
The track simply connects to the bottom of the Stationary Camshelving Unit. No bolts or drilling into the floor are required.

Ergonomic Access to Stored Product
Active aisle of 76,2 cm-91,44 cm provides easy access to all stored product. Low profile sloped rail design ensures easy access to product using the active aisle.

Raised Track
Raised track provides a smooth and level surface to easily roll mobile units. It ensures dirt will not get trapped, and is easy to clean. Mobile Units with heavy weight loads roll smoothly on track.

Roll Easily and Securely
Grooved casters roll easily and securely on raised track. Can be used on any surface, including tile and choppy floors.



Easy to Clean

- Camshelving is the most hygienic high density storage system available.
- Raised track ensures dirt will not get trapped, and is easy to clean.
- Aluminum track and stainless steel hardware are rust resistant.
- Shelf plates easily wipe clean or can be removed and run through the dishwasher.

Camshelving® High Density Storage System

Easy to Order

- Camshelving stationary units act as the system anchor.
- Mobile units with exclusive high density casters are available with vented or solid shelves.
- Mobile units can be ordered in convenient starter units, or custom built using Camshelving mobile post kits, shelf kits and high density casters.*

- Raised track kits ship with all hardware necessary for installation.

* Refer to pages 84 and 88 for components to build custom size Camshelving units.

Easy to Configure and Assemble

1. Determine your room size and needs. Multiple track kits can be used together to build the desired length of track.**
2. Choose starter unit size. Existing Camshelving stationary units can be retrofitted and utilized as the system anchors.
3. Choose high density mobile units, either starter units or build custom size units.
4. Different width stationary and mobile units may be used in single run of track.

** It is recommended to use a stationary unit for every 4,6 m of track to further stabilize the system.

System Components

- A Stationary Units
- B Mobile Units
- C Track
- D Active Aisle

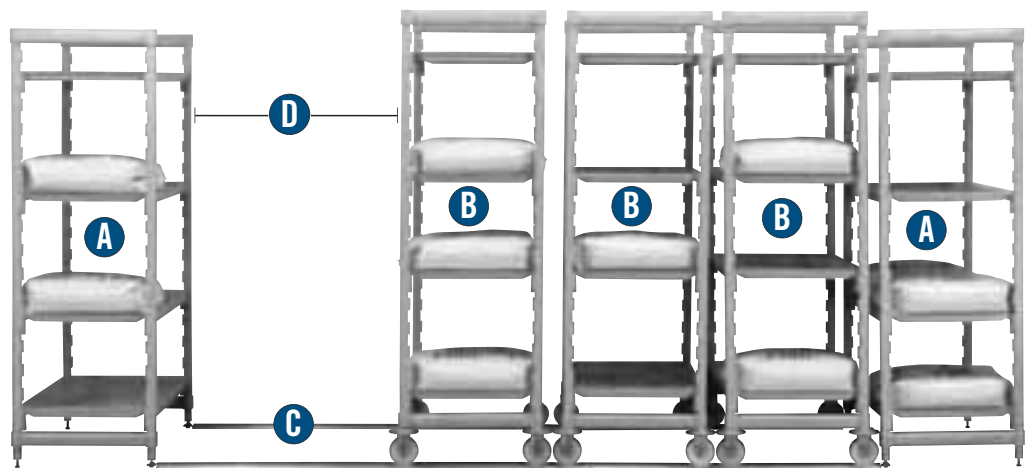

High Density Mobile Units include 4 High Density Casters.
Weight bearing capacity of High Density Mobile Camshelving Units is 340 Kg. It is recommended to use Fencing with High Density Camshelving. Refer to page 88 for product details.

All necessary hardware is included in the track kit.

CODE	DESCRIPTION	SIZE	CASE KG (CUBE M³)
Track Kits			
CSHDTK10	3,05 m Track Kit for 3 Mobile Units*	3050 mm	10,64 (0,010)
CSHDTK12	3,66 m Track Kit for 4 Mobile Units*	3660 mm	12,37 (0,011)
CSHDTK145	4,42 m Track Kit for 5 Mobile Units*	4420 mm	14,69 (0,013)
High Density Mobile Starter Units with Vented Shelves			
CSUHD44486	Mobile Unit 4 Vented Shelves	610 x 1220 x 1700 mm	51,36 (0,234)
CSUHD44487	Mobile Unit 4 Vented Shelves	610 x 1220 x 1910 mm	49,09 (0,234)
CSUHD44427	Mobile Unit 4 Vented Shelves	610 x 1070 x 1910 mm	48,97 (0,234)
CSUHD44367	Mobile Unit 4 Vented Shelves	610 x 910 x 1910 mm	44,97 (0,234)
High Density Mobile Starter Units with Solid Shelves			
CSUHD44486S	Mobile Unit 4 Solid Shelves	610 x 1220 x 1700 mm	52,63 (0,234)
CSUHD44487S	Mobile Unit 4 Solid Shelves	610 x 1220 x 1910 mm	50,37 (0,234)
CSUHD44427S	Mobile Unit 4 Solid Shelves	610 x 1070 x 1910 mm	52,08 (0,234)
CSUHD44367S	Mobile Unit 4 Solid Shelves	610 x 910 x 1910 mm	47,91 (0,234)
Case Pack: 1 Color: Speckled Gray (480) Track Kits Color: (000)			
CODE	DESCRIPTION	CASE PACK	CASE KG (CUBE M³)
Accessories			
CSHDDDB	High Density Donut Bumper	4	0,91 (0,001)
CSHDC	High Density Caster	2	1,86 (0,005)
CSHDFE	Floor Fastener	4	0,36 (0,001)

Color: Speckled Gray (480) Track Kits Color: (000)* Track holds up to 610 cm wide mobile units.

Security Cage For Camshelving®

- Provides safe storage for valuables such as steaks, seafood, wine, champagne and spirits.
- Stainless steel material is safe for use in coolers and freezers.
- Ideal for securing personal items such as purses and backpacks.
- Unique modular design provides the flexibility to retrofit one shelf at a time or an entire shelving unit.



Ideal for use in coolers and freezers.

CODE	DIMENSIONS W x L x H	CASE KG. (CUBE M ³)
CSSC2448	64 x 108 x 46 cm	13,2 (0,15)
Case Pack: 1	Padlock not included	

Pan Divider Bar for Camshelving®

- Create custom storage units that accommodate a variety of storage products and sizes on a single Camshelving unit.
- Angled and straight designs hold pans and boxes straight or on an angle for more ergonomic reach.
- Divider bars fit on 610 mm wide Camshelving units and hold up to 91 Kg. per shelf.
- Divider bars feature a raised bar on the edge to keep racks and pans from sliding off the front of the unit.



Camracks® fit on divider bars to create a warewashing drying and storage station.



Divider bars hold any size food pans from GN 1/1 to GN 1/9.



CODE	DESCRIPTION	CASE KG (CUBE M ³)
CSDBA	Divider Bar Angled	0,904 (0,003)
CSDBS	Divider Bar Straight	0,904 (0,003)

Case Pack: 4 Color: Speckled Grey (480).

30,5 x 46 cm food boxes with sliding lids can be used with divider bars for hygienic food storage.

Tray Slide Rack for Camshelving®

- Holds six 46 x 66 cm sheet pans.
- Made from Aluminum which is safe for use in coolers and freezers.
- Fits on Camshelving units 610 mm wide and 610 mm in length or longer.



CODE	DIMENSIONS W x L x H	CASE KG (CUBE M ³)
CSTSR	52,71 x 59,05 x 51,44 cm	6,82(0,16)

Case Pack: 1 Color: 000.

Camshelving®

ELEMENTS SERIES



The Future of Shelving

Strong as Steel

State-of-the-art, composite material is as strong as steel.



Lifetime Warranty

Lifetime warranty against rust and corrosion, ideal for use in cold, hot, wet and dry environments.



Easy To Clean

Dishwasher safe, removable shelf plates are embedded with Camguard® antimicrobial protection.

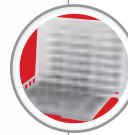

Camshelving® Elements Series

STRONG TECHNOLOGY



- Composite material is as strong as steel.
- 1980 mm traverse is the longest and strongest in the industry; supports loads up to 272 Kg per shelf.
- 60% lighter in weight than steel; easy to set up, adjust and change configurations.
- Resistant to moisture; won't rust or corrode.

HYGIENIC DESIGN



- Non-porous surface simply wipes clean.
- Shelf plates are easily removed for thorough dishwasher cleaning.
- Camguard® Antimicrobial protection is permanently embedded in shelf plates.
- Camguard works continuously to suppress the growth of microbes between cleanings.

SHELVING FOR LIFE



- Lifetime warranty against corrosion and rust.
- Withstands temperatures as cold as -38°C or warm environments up to 88°C.
- Ideal for wet, dry, cold or humid environments.
- Impervious to moisture and chemicals.
- Won't peel, dent or warp; corrosion resistant.

Weight Capacity

	TRAVERSE LENGTH (mm)	US self certification weight bearing capacity		TÜV certification weight bearing capacity	
		PER SHELF	PER UNIT	PER SHELF	PER UNIT
Single Unit	760 - 1220	363 Kg	1451 Kg	250 Kg	1250 Kg
	1380 - 1530	272 Kg	1089 Kg	200 Kg	1250 Kg
	1830	272 Kg	1089 Kg	175 Kg	1250 Kg
	1980	272 Kg	1089 Kg	150 Kg	1250 Kg
Dunnage Stand	1380 - 1980	454 Kg bottom shelf only	—	—	—
Corner Unit (4 shelves)	910 - 1220	180 Kg	720 Kg	—	—
Mobile Unit (4 shelves)	910 - 1530	—	409 Kg	—	—

Dunnage Stands are recommended for units 1380 mm or longer.

Corner Connectors are recommended for use on traverses 1220 mm or less.

Due to the weight bearing capacity of casters, maximum weight load on an entire Mobile Elements unit is 409 Kg.



Camshelving® Elements Series Stationary Traverse Dovetails are covered by Patent # D623,929.
 Camshelving® Elements Series Stationary Traverse Corner Connectors are covered by Patent # D624,764.
 Other Camshelving® Elements Series Components are Patent Pending.

Maximize Space Utilization

Elements is available in partially assembled starter and add-on units for ease of ordering and assembly.

4-Shelf Stationary Starter Units

- Ship complete in one box with two post kits, 8 stationary traverses, 32 stationary dovetails and shelf plates to build one entire unit.



Dunnage Stand

- Increases weight bearing capacity to 454 Kg on the bottom shelf.
- Recommended for units 1380 mm or longer.

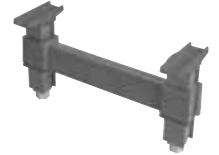

4-Shelf Add-On Units

- Ship complete in one box with one post kit, 8 traverses, 32 dovetails and shelf plates to attach to an adjoining unit.
- The traverses on both units share the middle posts, maximizing space.
- No add-on clips or S-hooks required.
- No loss of weight bearing capacity when built in a straight line.



Seismic Foot

- Bolts a post to the floor for a more stable base.
- Screws not included.



Corner Units & U-Shape Units

- Corner connectors can be used to build Corner and U-Shaped units.
- Corner connectors easily snap onto traverses.
- Corner connector set attaches a starter unit to a second unit at a 90° angle or to form a U-shape.
- A set of corner connectors are needed for each shelf.

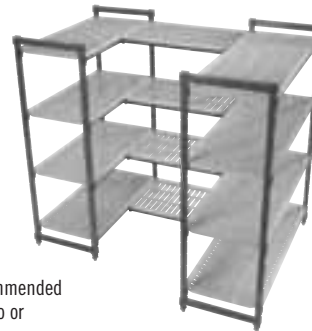

Corner connectors are recommended for use on traverses equal to or shorter than 1220 mm, and are covered by U.S. Patent D624,764.

Wall Fastener

- Fastens a unit to a wall as a safety precaution.
- Screws not included.



Identification Tag

- Easily clips onto traverses to identify stored items.
- Made of PVC.
- Includes 12 HACCP labels.



4-Shelf Mobile Starter Units

- Mobile starter units ship complete in one box with 2 post kits, 8 mobile traverses, 32 mobile dovetails, shelf plates and 4 casters.
- Mobile traverses feature a 45° gusset for maximum cross-stabilization.
- Available with standard or premium casters.
- Mobile units are not designed to serve as transport carts.
- Mobile traverses and mobile dovetails are required to build a Mobile Elements Series Unit.



Donut Bumper

- Protects posts and casters.
- 127 mm Bumper.



Camshelving® Elements Series Configuration Details

- The following charts are provided to assist in developing a footprint for your storage area.
- They can also be used to help determine your actual shelf space.
- Shelf measurements are based on outside, or overall unit length and width including the posts.
- The overall length varies slightly when using an add-on, intermediate or corner unit.
- These variations are outlined below.

Shelf Spacing

Notches for dovetails are spaced every 100 mm.

POST HEIGHT	NUMBER OF POSITIONS PER POST	POST HEIGHT WITH CASTER	NUMBER OF POSITIONS PER POST
Stationary		Mobile	
1630 mm	14	1778 mm	14
1830 mm	16	1980 mm	16
2140 mm	19		

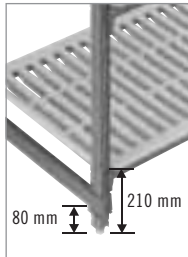

Easy To Adjust

Build Any Configuration and Fit Any Size Area

- Create a space efficient layout for any area.
- Assembles requiring only the use of a rubber mallet.
- Shelves can be adjusted in 100 mm increments without disassembling the entire unit.
- Two units can be connected together by sharing posts with shelves at alternating heights for maximum storage flexibility.
- Corner Connectors attach units to create a 90° angle or U-shape.

POST HEIGHT	DOVETAIL INCREMENT	NUMBER OF POSITIONS PER POST
Stationary		
1630 mm	100 mm	14
1830 mm	100 mm	16
2140 mm	100 mm	19
Mobile		
1778 mm	100 mm	14
1980 mm	100 mm	16

Shelving Consulting

Cambro provides a free consulting service to maximize your storage area. No cost or obligation.



1. Simply provide the dimensions of the storage space, number of shelves per unit, height of the posts, and any additional requirements you have.
2. Cambro will provide a recommended floor plan, 3-D view and product order list in Excel.
3. Your Cambro distributor or sales representative will contact you with pricing.
4. To contact the Camshelving Consulting Department, please call 1-714-230-4113, Fax 1-714-230-4199 or email mperez@cambro.com.

Starter Unit

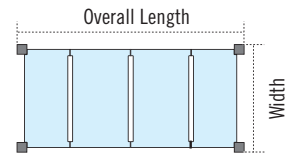

Add-on Unit

Shared posts between starter unit and add-on unit maximize space.

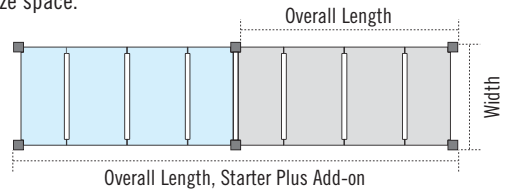

Corner Unit

Using one set of Corner Connectors per shelf.

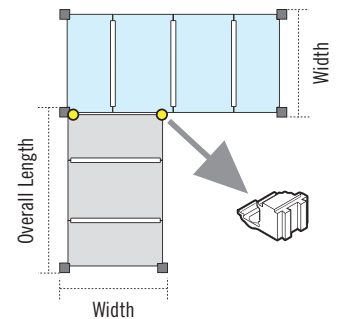

U-Shaped Unit

Requires two sets of corner connectors per shelf.

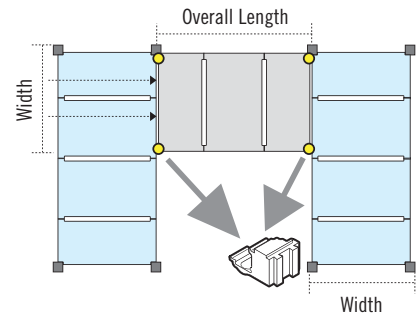

UNIT	CORNER UNIT OVERALL LENGTH	INTERMEDIATE UNIT OVERALL LENGTH
760 mm	740 mm	715 mm
910 mm	890 mm	865 mm
1070 mm	1045 mm	1020 mm
1220 mm	1195 mm	1170 mm

Corner Connectors are recommended for use on traverses 1220 mm or less.

UNIT	STARTER UNIT OVERALL LENGTH	ADD-ON UNIT OVERALL LENGTH	STARTER + ADD-ON UNIT OVERALL LENGTH
760 mm	760 mm	720 mm	1480 mm
910 mm	910 mm	870 mm	1780 mm
1070 mm	1070 mm	1025 mm	2095 mm
1220 mm	1220 mm	1175 mm	2395 mm
1380 mm	1380 mm	1330 mm	2710 mm
1530 mm	1530 mm	1480 mm	3010 mm
1830 mm	1830 mm	1790 mm	3620 mm
1980 mm	1980 mm	1940 mm	3920 mm

Stationary Post Kits

Camshelving®
Elements Series

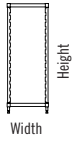

	WIDTH	360 mm	460 mm	540 mm	610 mm
HEIGHT 1630 mm	CODE	EPK1464	EPK1864	EPK2164	EPK2464
	CASE KG/CUBE M³	3,82 (0,01)	3,93 (0,01)	4,01 (0,01)	4,09 (0,01)
1830 mm	CODE	EPK1472	EPK1872	EPK2172	EPK2472
	CASE KG/CUBE M³	4,20 (0,01)	4,31 (0,01)	4,39 (0,01)	4,47 (0,01)
2140 mm	CODE	EPK1484	EPK1884	EPK2184	EPK2484
	CASE KG/CUBE M³	4,76 (0,02)	4,86 (0,02)	4,94 (0,02)	5,02 (0,02)

Includes 2 stationary posts with leveling feet installed, 1 top post connector, 1 bottom post connector, 8 post connector wedges in a bag and instructions.
Case Pack: 1 Color: Brushed Graphite (580).

Optional Accessories

Dunnage Stands

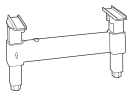

	WIDTH	360 mm	460 mm	540 mm	610 mm
HEIGHT 165 mm	CODE	EDS14	EDS18	EDS21	EDS24
	CASE KG/CUBE M³	0,88 (0,001)	0,93 (0,006)	0,97 (0,007)	1,01 (0,008)

Case Pack: 1 Color: Brushed Graphite (580).

Accessories

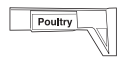
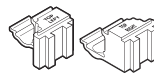
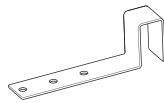

DESCRIPTION	Seismic Foot	Wall Fastener	90° Left & Right Corner Connectors	ID Tag 150 mm	ID Tag 80 mm
CODE	CSEQ3	CSWF	ECC	CSID	CSID3
COLOR	Silver	Silver	Brushed Graphite (580)	White/Clear	White/Clear
CASE KG/CUBE M³	0,62 (0,011)	1,85 (0,006)	0,32 (0,001)	0,37 (0,01)	0,35 (0,01)
CASE PACK	4 each	4 each	1 set	12 each	12 each

Solid Single Shelf Kits for Stationary Units

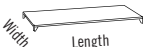
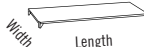

Camshelving®
Elements Series

 WIDTH 360 mm	LENGTH	760 <small>New!</small> mm	910 mm	1070 mm	1220 mm
	CODE	ESK1430S	ESK1436S	ESK1442S	ESK1448S
CASE KG/CUBE M ³	3,03 (0,03)	3,73 (0,04)	4,43 (0,06)	4,76 (0,04)	
WIDTH 460 mm	CODE	ESK1830S	ESK1836S	ESK1842S	ESK1848S
	CASE KG/CUBE M ³	3,42 (0,03)	4,19 (0,04)	5,03 (0,06)	5,34 (0,04)
WIDTH 540 mm	CODE	ESK2130S	ESK2136S	ESK2142S	ESK2148S
	CASE KG/CUBE M ³	3,80 (0,03)	4,83 (0,04)	5,72 (0,06)	6,21 (0,04)
WIDTH 610 mm	CODE	ESK2430S	ESK2436S	ESK2442S	ESK2448S
	CASE KG/CUBE M ³	4,14 (0,03)	5,17 (0,04)	6,12 (0,06)	6,76 (0,04)
 WIDTH 360 mm	LENGTH	1380 mm	1530 mm	1830 mm	1980 CAMBRO Exclusive mm
	CODE	ESK1454S	ESK1460S	ESK1472S	ESK1478S
CASE KG/CUBE M ³	5,51 (0,07)	6,20 (0,08)	7,16 (0,09)	7,59 (0,10)	
WIDTH 460 mm	CODE	ESK1854S	ESK1860S	ESK1872S	ESK1878S
	CASE KG/CUBE M ³	6,23 (0,07)	7,07 (0,08)	8,16 (0,09)	8,58 (0,10)
WIDTH 540 mm	CODE	ESK2154S	ESK2160S	ESK2172S	ESK2178S
	CASE KG/CUBE M ³	7,15 (0,07)	8,03 (0,08)	9,35 (0,09)	9,78 (0,10)
WIDTH 610 mm	CODE	ESK2454S	ESK2460S	ESK2472S	ESK2478S
	CASE KG/CUBE M ³	7,75 (0,07)	8,69 (0,08)	10,21 (0,09)	10,64 (0,10)

SINGLE SHELF - Includes solid shelf plates for 1 shelf, 2 stationary traverses, 1 bag of 8 stationary traverse dovetails (4 each A and B) and instructions.
Case Pack: 1 **Color:** Brushed Graphite (580).

Vented Single and 4-Shelf Kits for Stationary Units

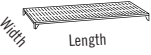
Camshelving®
Elements Series

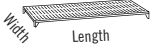
 WIDTH 360_A mm	LENGTH	760  mm	910 mm	1070 mm	1220 mm
	CODE	ESK1430V	ESK1436V	ESK1442V	ESK1448V
CASE KG/CUBE M ³	2,91 (0,03)	3,57 (0,04)	4,24 (0,06)	4,52 (0,04)	
460_A mm	CODE	ESK1830V	ESK1836V	ESK1842V	ESK1848V
	CASE KG/CUBE M ³	3,24 (0,03)	3,97 (0,04)	4,75 (0,06)	5,05 (0,04)
540_A mm	CODE	ESK2130V	ESK2136V	ESK2142V	ESK2148V
	CASE KG/CUBE M ³	3,47 (0,03)	4,42 (0,04)	5,28 (0,06)	5,65 (0,04)
610_A mm	CODE	ESK2430V	ESK2436V	ESK2442V	ESK2448V
	CASE KG/CUBE M ³	3,85 (0,03)	4,79 (0,04)	5,70 (0,06)	6,24 (0,04)
460_B mm	CODE	—	ESK1836V4	—	ESK1848V4
	CASE KG/CUBE M ³	—	14,57 (0,11)	—	18,63 (0,12)
610_B mm	CODE	—	ESK2436V4	—	ESK2448V4
	CASE KG/CUBE M ³	—	17,85 (0,11)	—	23,39 (0,12)
 WIDTH 360_A mm	LENGTH	1380 mm	1530 mm	1830 mm	1980 CAMBRO Exclusive mm
	CODE	ESK1454V	ESK1460V	ESK1472V	ESK1478V
CASE KG/CUBE M ³	5,24 (0,07)	5,90 (0,08)	6,78 (0,09)	7,21 (0,10)	
460_A mm	CODE	ESK1854V	ESK1860V	ESK1872V	ESK1878V
	CASE KG/CUBE M ³	5,87 (0,07)	6,63 (0,08)	7,64 (0,09)	8,07 (0,10)
540_A mm	CODE	ESK2154V	ESK2160V	ESK2172V	ESK2178V
	CASE KG/CUBE M ³	6,56 (0,07)	7,41 (0,08)	8,58 (0,09)	9 (0,10)
610_A mm	CODE	ESK2454V	ESK2460V	ESK2472V	ESK2478V
	CASE KG/CUBE M ³	7,20 (0,07)	8,11 (0,08)	9,49 (0,09)	9,92 (0,10)
460_B mm	CODE	—	ESK1860V4	—	—
	CASE KG/CUBE M ³	—	23,32 (0,16)	—	—
610_B mm	CODE	—	ESK2460V4	—	—
	CASE KG/CUBE M ³	—	29,24 (0,16)	—	—

A - SINGLE SHELF - Includes vented shelf plates for 1 shelf, 2 stationary traverses, 1 bag of 8 stationary traverse dovetails (4 each A and B) and instructions.
 B - FOUR SHELVES - Includes vented shelf plates for 4 shelves, 8 stationary traverses, 1 bag of 32 stationary traverse dovetails (16 each A and B) and instructions.
 Case Pack: 1 Color: Brushed Graphite (580).

Vented 4-Shelf Stationary Starter Units 460 mm Width

Camshelving®
Elements Series

 HEIGHT 1630 mm	LENGTH	910	1070	1220	1380	1530
		mm	mm	mm	mm	mm
1830 mm	CODE	ESU183664	ESU184264	ESU184864	ESU185464	ESU186064
	CASE KG/CUBE M ³	22,68 (0,17)	24,74 (0,17)	26,74 (0,17)	28,87 (0,17)	30,96 (0,17)
1630 mm	CODE	ESU183672	ESU184272	ESU184872	ESU185472	ESU186072
	CASE KG/CUBE M ³	23,26 (0,17)	25,32 (0,17)	27,32 (0,17)	29,45 (0,17)	31,54 (0,17)

Includes 4 stationary posts with leveling feet installed - pre-assembled with post connectors and wedges, 1 bag of 32 stationary traverse dovetails (16 A and 16 B), vented shelf plates (for 4 shelves), 8 stationary traverses and instructions.
Case Pack: 1 **Color:** Brushed Graphite (580).

Vented 4-Shelf Stationary Starter Units 540 mm Width

 HEIGHT 1630 mm	LENGTH	910	1070	1220	1380	1530
		mm	mm	mm	mm	mm
1830 mm	CODE	ESU213664	ESU214264	ESU214864	ESU215464	ESU216064
	CASE KG/CUBE M ³	24,92 (0,21)	27,32 (0,21)	29,61 (0,21)	32,09 (0,21)	34,52 (0,21)
1630 mm	CODE	ESU213672	ESU214272	ESU214872	ESU215472	ESU216072
	CASE KG/CUBE M ³	25,50 (0,21)	27,90 (0,21)	30,20 (0,21)	32,67 (0,21)	35,10 (0,21)

Includes 4 stationary posts with leveling feet installed - pre-assembled with post connectors and wedges, 1 bag of 32 stationary traverse dovetails (16 A and 16 B), vented shelf plates (for 4 shelves), 8 stationary traverses and instructions.
Case Pack: 1 **Color:** Brushed Graphite (580).

Vented 4-Shelf Stationary Starter Units 610 mm Width

 HEIGHT 1630 mm	LENGTH	910	1070	1220	1380	1530
		mm	mm	mm	mm	mm
1830 mm	CODE	ESU243664	ESU244264	ESU244864	ESU245464	ESU246064
	CASE KG/CUBE M ³	26,99 (0,24)	27,97 (0,24)	32,53 (0,24)	35,24 (0,24)	37,92 (0,24)
2140 mm	CODE	ESU243672	ESU244272	ESU244872	ESU245472	ESU246072
	CASE KG/CUBE M ³	27,57 (0,24)	30,21 (0,24)	33,11 (0,24)	35,82 (0,24)	38,50 (0,24)
*2140 mm	CODE	ESU243684PKG	ESU244284PKG	ESU244884PKG	ESU245484PKG	ESU246084PKG
	CASE KG/CUBE M ³	27,88 (0,14)	30,51 (0,17)	33,42 (0,16)	36,58 (0,2)	39,26 (0,2)

Includes 4 stationary posts with leveling feet installed - pre-assembled with post connectors and wedges, 1 bag of 32 stationary traverse dovetails (16 A and 16 B), vented shelf plates (for 4 shelves), 8 stationary traverses and instructions.
Case Pack: 1 **Color:** Brushed Graphite (580).

* Due to the size of 2140 mm shelving, starter units ship in 3 cartons.

Vented 4-Shelf Stationary Add-On Units 460 mm Width

Camshelving®
Elements Series

 HEIGHT 1630 mm	LENGTH	910 mm	1070 mm	1220 mm	1380 mm	1530 mm
	CODE	EA183664	EA184264	EA184864	EA185464	EA186064
CASE KG/CUBE M ³	19,21 (0,17)	21,27 (0,17)	23,27 (0,17)	25,40 (0,17)	27,49 (0,17)	
 HEIGHT 1830 mm	CODE	EA183672	EA184272	EA184872	EA185472	EA186072
	CASE KG/CUBE M ³	19,50 (0,17)	21,56 (0,17)	23,56 (0,17)	25,69 (0,17)	27,78 (0,17)

Includes 2 stationary posts with leveling feet installed - pre-assembled with post connectors and wedges, 1 bag of 32 stationary traverse dovetails (16 A and 16 B), vented shelf plates (for 4 shelves), 8 stationary traverses and instructions.
Case Pack: 1 Color: Brushed Graphite (580).

Vented 4-Shelf Stationary Add-On Units 540 mm Width

 HEIGHT 1630 mm	LENGTH	910 mm	1070 mm	1220 mm	1380 mm	1530 mm
	CODE	EA213664	EA214264	EA214864	EA215464	EA216064
CASE KG/CUBE M ³	21,38 (0,21)	23,78 (0,21)	26,07 (0,21)	28,54 (0,21)	30,98 (0,21)	
 HEIGHT 1830 mm	CODE	EA213672	EA214272	EA214872	EA215472	EA216072
	CASE KG/CUBE M ³	21,67 (0,21)	24,07 (0,21)	26,36 (0,21)	28,83 (0,21)	31,27 (0,21)

Includes 2 stationary posts with leveling feet installed - pre-assembled with post connectors and wedges, 1 bag of 32 stationary traverse dovetails (16 A and 16 B), vented shelf plates (for 4 shelves), 8 stationary traverses and instructions.
Case Pack: 1 Color: Brushed Graphite (580).

Vented 4-Shelf Stationary Add-On Units 610 mm Width

 HEIGHT 1630 mm	LENGTH	910 mm	1070 mm	1220 mm	1380 mm	1530 mm
	CODE	EA243664	EA244264	EA244864	EA245464	EA246064
CASE KG/CUBE M ³	23,36 (0,24)	25,99 (0,24)	28,91 (0,24)	31,62 (0,24)	34,29 (0,24)	
 HEIGHT 1830 mm	CODE	EA243672	EA244272	EA244872	EA245472	EA246072
	CASE KG/CUBE M ³	23,65 (0,24)	26,29 (0,24)	29,20 (0,24)	31,91 (0,24)	34,58 (0,24)
 HEIGHT *2140 mm	CODE	EA243684PKG	EA244284PKG	EA244884PKG	EA245484PKG	EA246084PKG
	CASE KG/CUBE M ³	22,85 (0,12)	25,49 (0,16)	28,40 (0,14)	31,56 (0,18)	34,24 (0,18)

Includes 2 stationary posts with leveling feet installed - pre-assembled with post connectors and wedges, 1 bag of 32 stationary traverse dovetails (16 A and 16 B), vented shelf plates (for 4 shelves), 8 stationary traverses, instructions

Case Pack: 1 Color: Brushed Graphite (580).

* Due to the size of 2140 mm shelving, add-on units ship in 2 cartons.

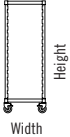

Mobile Post Kits

Camshelving®
Elements Series

 WIDTH 460 mm	540 mm		610 mm	
	HEIGHT 1778 mm	CODE	EMPK1870	EMPK2170
	CASE KG/CUBE M ³	3,93 (0,01)	4,01 (0,01)	4,09 (0,01)
HEIGHT 1980 mm	CODE	EMPK1878	EMPK2178	EMPK2478
	CASE KG/CUBE M ³	4,31 (0,01)	4,39 (0,01)	4,47 (0,01)

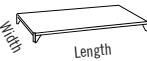

Includes 2 mobile posts without leveling feet installed, 1 top post connector, 1 bottom post connector, 8 post connector wedges in a bag and instructions. Casters are not included and must be ordered separately. **Note:** Height in chart includes casters.
Case Pack: 1 Color: Brushed Graphite (580).

Solid Shelf Kits for Mobile Units

 WIDTH 460 mm	LENGTH	910 mm	1070 mm	1220 mm	1380 mm 	1530 mm 
	CODE	EMSK1836S	EMSK1842S	EMSK1848S	EMSK1854S	EMSK1860S
CASE KG/CUBE M ³	4,40 (0,04)	5,24 (0,06)	5,55 (0,04)	6,35 (0,07)	7,12 (0,08)	
WIDTH 540 mm	CODE	EMSK2136S	EMSK2142S	EMSK2148S	EMSK2154S	EMSK2160S
CASE KG/CUBE M ³	5,04 (0,04)	5,93 (0,06)	6,24 (0,04)	7,26 (0,07)	8,16 (0,08)	
WIDTH 610 mm	CODE	EMSK2436S	EMSK2442S	EMSK2448S	EMSK2454S	EMSK2460S
CASE KG/CUBE M ³	5,38 (0,04)	6,33 (0,06)	6,97 (0,04)	7,86 (0,07)	8,81 (0,08)	

Includes solid shelf plates for 1 shelf, 2 mobile traverses, 1 bag of 8 mobile traverse dovetails (4 each A and B) and instructions.
Case Pack: 1 Color: Brushed Graphite (580).

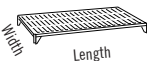
Vented Shelf Kits for Mobile Units

 WIDTH 460 mm	LENGTH	910 mm	1070 mm	1220 mm	1380 mm 	1530 mm 
	CODE	EMSK1836V	EMSK1842V	EMSK1848V	EMSK1854V	EMSK1860V
CASE KG/CUBE M ³	4,18 (0,04)	4,96 (0,06)	5,26 (0,04)	5,97 (0,07)	6,75 (0,08)	
WIDTH 540 mm	CODE	EMSK2136V	EMSK2142V	EMSK2148V	EMSK2154V	EMSK2160V
CASE KG/CUBE M ³	4,63 (0,04)	5,49 (0,06)	5,86 (0,04)	6,67 (0,07)	7,53 (0,08)	
WIDTH 610 mm	CODE	EMSK2436V	EMSK2442V	EMSK2448V	EMSK2454V	EMSK2460V
CASE KG/CUBE M ³	4,99 (0,04)	5,92 (0,06)	6,45 (0,04)	7,31 (0,07)	8,23 (0,08)	

Includes vented shelf plates for 1 shelf, 2 mobile traverses, 1 bag of 8 mobile traverse dovetails (4 each A and B) and instructions.
Case Pack: 1 Color: Brushed Graphite (580).

Vented 4-Shelf Mobile Starter Units 460 mm Width

Camshelving®
Elements Series



HEIGHT	LENGTH	910mm	910mm	1070mm	1070mm	1220mm	1220mm
		PREMIUM	STANDARD	PREMIUM	STANDARD	PREMIUM	STANDARD
1778 mm	CODE	EMU183670P	EMU183670	EMU184270P	EMU184270	EMU184870P	EMU184870
	CASE KG/CUBE M ³	33,48 (0,17)	33,48 (0,17)	36,52 (0,17)	36,52 (0,17)	39,61 (0,17)	39,61 (0,17)
1980 mm	CODE	EMU183678P	EMU183678	EMU184278P	EMU184278	EMU184878P	EMU184878
	CASE KG/CUBE M ³	34,06 (0,17)	34,06 (0,17)	37,09 (0,17)	37,09 (0,17)	40,19 (0,17)	40,19 (0,17)

Premium - Includes 4 mobile posts without leveling feet, post connectors and wedges installed, 1 bag of 32 mobile traverse dovetails (16 each A and B), vented shelf plates, 8 mobile traverses, 4 premium casters and instructions.

Standard - Includes 4 mobile posts without leveling feet, post connectors and wedges installed, 1 bag of 32 mobile traverse dovetails (16 each A and B), vented shelf plates, 8 mobile traverses, 4 standard casters and instructions.

Case Pack: 1 **Color:** Brushed Graphite (580).

Vented 4-Shelf Mobile Starter Units 540 mm Width



HEIGHT	LENGTH	910mm	910mm	1070mm	1070mm	1220mm	1220mm
		PREMIUM	STANDARD	PREMIUM	STANDARD	PREMIUM	STANDARD
1778 mm	CODE	EMU213670P	EMU213670	EMU214270P	EMU214270	EMU214870P	EMU214870
	CASE KG/CUBE M ³	35,72 (0,21)	35,72 (0,21)	39,10 (0,21)	39,10 (0,21)	42,49 (0,21)	44,82 (0,21)
1980 mm	CODE	EMU213678P	EMU213678	EMU214278P	EMU214278	EMU214878P	EMU214878
	CASE KG/CUBE M ³	36,31 (0,21)	36,31 (0,21)	39,68 (0,21)	39,68 (0,21)	43,07 (0,21)	45,40 (0,21)

Premium - Includes 4 mobile posts without leveling feet, post connectors and wedges installed, 1 bag of 32 mobile traverse dovetails (16 each A and B), vented shelf plates, 8 mobile traverses, 4 premium casters and instructions.

Standard - Includes 4 mobile posts without leveling feet, post connectors and wedges installed, 1 bag of 32 mobile traverse dovetails (16 each A and B), vented shelf plates, 8 mobile traverses, 4 standard casters and instructions.

Case Pack: 1 **Color:** Brushed Graphite (580).

Vented 4-Shelf Mobile Starter Units 610 mm Width



HEIGHT	LENGTH	910mm	910mm	1070mm	1070mm	1220mm	1220mm
		PREMIUM	STANDARD	PREMIUM	STANDARD	PREMIUM	STANDARD
1778 mm	CODE	EMU243670P	EMU243670	EMU244270P	EMU244270	EMU244870P	EMU244870
	CASE KG/CUBE M ³	37,79 (0,24)	37,79 (0,24)	41,41 (0,24)	41,41 (0,24)	45,40 (0,24)	45,40 (0,24)
1980 mm	CODE	EMU243678P	EMU243678	EMU244278P	EMU244278	EMU244878P	EMU244878
	CASE KG/CUBE M ³	38,37 (0,24)	38,37 (0,24)	41,99 (0,24)	41,99 (0,24)	45,98 (0,24)	45,98 (0,24)

Premium - Includes 4 mobile posts without leveling feet, connectors and wedges installed, 1 bag of 32 mobile traverse dovetails (16 each A and B), vented shelf plates, 8 mobile traverses, 4 premium casters, instructions.

Standard - Includes 4 posts without leveling feet, connectors and wedges installed, 1 bags of 32 mobile traverse dovetails (16 each A and B), shelf plates, 8 mobile traverses, 4 standard casters, instructions.

Case Pack: 1 **Color:** Brushed Graphite (580).

Casters and Donut Bumper

Camshelving®
Elements Series



DIAMETER	127 mm PREMIUM	127 mm PREMIUM	127 mm STANDARD	127 mm STANDARD	127 mm
CODE	EMSCBP	EMSCP	EMSCB	EMSC	CSHDDB
DESCRIPTION	Swivel with Brake	Swivel No Brake	Swivel with Brake	Swivel No Brake	Donut Bumper
CASE KG/CUBE M ³	2,16 (0,005)	1,97 (0,005)	2,16 (0,005)	1,97 (0,005)	0,91 (0,001)
CASE PACK	2	2	2	2	4

PREMIUM CASTERS - Stainless steel with a non-marking polyurethane wheel. Recommended for use in wet areas or in walk-in refrigerators and freezers.

STANDARD CASTERS - Zinc plated with a non-marking polyurethane wheel. Recommended for use in dry storage areas.

Divider Bar for Elements Series

- Creates a custom storage unit that can accommodate a variety of storage products and sizes on a single unit.
- Divider bars fit on 610 mm wide Elements Series units and hold up to 91 Kg per shelf.



CODE	DESCRIPTION	CASE KG/CUBE M ³
EDBA	Divider Bar Angled	0,87 (0,003)
EDBS	Divider Bar Straight	0,87 (0,003)

Case Pack: 4 Color: Speckled Gray (480).

Camshelving® Wall Shelves And Storesafe® Shelf Extenders

Wall Shelves

- Expand storage space in kitchens, above work stations and sinks.
- Features virtually indestructible I-beam supports that hold up to 68 Kg per shelf.
- Durable polypropylene withstands temperatures up to 88°C, and will not rust or corrode.

- Snap fit rail design allows shelves to snap on and off for easy cleaning.
- 5 cm backsplash and marine front edge controls spills and cross contamination.

Shelf Extenders

- Convert empty wall space into a functional storage area.
- Use with or without Camshelving Wall Shelves.
- Peg strips withstand temperatures up to 88°C, and will not rust or corrode.

Wall Shelf Color: Speckled Grey (480).

Extender Peg Strip Color: Black (110).

Wall Shelf Kits are covered by the following U.S. Patents D 508,646S & D 512,867 S.



COMPONENTS



Shelf Extenders ship in one carton with all hardware and include:

LENGTH	PEG STRIPS	BRACKETS	HOOKS
91 cm	3	2	6
122 cm	3	3	9



CODE	CSWS1436SK	CSWS1448SK	CSWS1436VK	CSWS1448VK
DESCRIPTION	91 cm Wall Shelf, Solid	122 cm Wall Shelf, Solid	91 cm Wall Shelf, Vented	122 cm Wall Shelf, Vented
EXTERIOR DIMENSIONS	L 91 x W 36 x H 34 cm	L 122 x W 36 x H 34 cm	L 91 x W 36 x H 34 cm	L 122 x W 36 x H 34 cm
CASE KG. (CUBE M ³)	4,6 (0,04)	5,7 (0,05)	4,4 (0,04)	5,3 (0,05)

Case Pack: 1

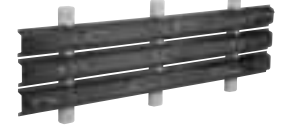

CODE	CSWS1836SK	CSWS1848SK	CSWS36EK	CSWS48EK
DESCRIPTION	91 cm Wall Shelf, Solid	122 cm Wall Shelf, Solid	91 cm Shelf Extender	122 cm Shelf Extender
EXTERIOR DIMENSIONS	L 91 x W 46 x H 34 cm	L 122 x W 46 x H 34 cm	L 90 x W 5 x H 39 cm	L 121 x W 5 x H 39 cm
CASE KG. (CUBE M ³)	5,34 (0,044)	6,56 (0,058)	2,9 (0,01)	3,9 (0,01)

Case Pack: 1

Case Pack: 1

S-SERIES DUNNAGE RACKS & CAMLINK®



S-Series Dunnage Racks

Colors: Dark Brown (131),
Speckled Gray (480).



- Keep frozen, cold or dry inventory 30,5 cm safely off the floor.
- One piece construction and sturdy legs provide strength and stability.
- Heavy duty polypropylene is safe to -38°C, and will not rust, corrode or bend.
- Choose slotted tops for maximum air circulation around perishable products.
- Solid tops catch spills for easy clean up.

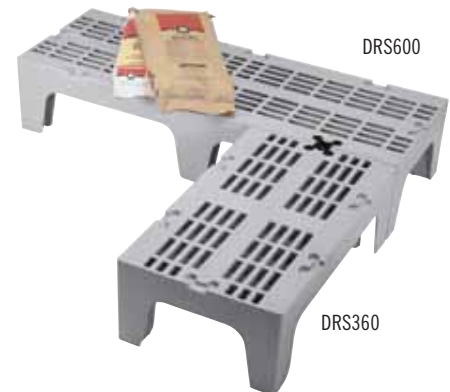

CODE	EXTERIOR DIMENSIONS H x D x W	LOAD CAPACITY	CASE KG/CUBE M ³
Solid Top			
DRS30	30 x 53,3 x 76 cm	680 Kg	9,45 (0,14)
DRS36	30 x 53,3 x 91,5 cm	680 Kg	11,70 (0,17)
DRS48	30 x 53,3 x 122 cm	1,360 Kg	15,08 (0,23)
DRS60	30 x 53,3 x 152,5 cm	1,360 Kg	17,55 (0,29)
Slotted Top			
DRS300	30 x 53,3 x 76 cm	680 Kg	9 (0,14)
DRS360	30 x 53,3 x 91,5 cm	680 Kg	11,25 (0,17)
DRS480	30 x 53,3 x 122 cm	1,360 Kg	14,63 (0,23)
DRS600	30 x 53,3 x 152,5 cm	1,360 Kg	17,10 (0,29)

Case Pack: 1

Camlink®

Camlink connectors securely lock dunnage racks together for greater stability.



Color: Black (110).

Camlink is covered by U.S. Patent D 397,289.

Camlink fits all sizes and styles. One free Camlink supplied with every Dunnage Rack.

CODE	CASE PACK
DRLNK	6



FOOD STORAGE & PREPARATION



Quick Guide To Storage Solutions



Storage Containers

CamSquares® Food Storage Containers

Keeps food fresh and maximizes storage areas.



7	3	2
SIZES	MATERIALS	LID TYPES

ColdFest®

GN Pans

Holds cold food at safe temperatures without ice for hours.



4	1	1	5
SIZES	DEPTH	MATERIAL	LID TYPES

Round Food Storage Containers

Store ingredients or transport ready to serve or partially prepared foods.



8	3	4
SIZES	MATERIALS	LID TYPES

Ingredient Bins

Store dry bulk ingredients such as flour and grain.



6	1	3
CAPACITIES	COLOR	LID TYPES

Food Storage Boxes

Safely store bulk produce, meat, poultry and seafood.



2	5	2	2
SIZES	DEPTHS	MATERIALS	LID TYPES



Materials

Camwear® Polycarbonate

Virtually unbreakable polycarbonate material will not crack, bend or dent. Withstands temperatures from -40°C to 99°C.

High Heat H-Pans™

High heat material is safe for use in microwaves, ovens and steam tables. Withstands extreme temperatures from -40°C to 190°C.

Polypropylene

Translucent polypropylene material provides a high chemical resistance. Withstands temperatures from -40°C to 70°C.

Polyethylene

High chemical and impact resistant material. Withstands temperatures from -40°C to 70°C.

ABS

High-performance and impact resistant material. Ideal for temperatures at or below 4°C.



Food Pans

Camwear® Polycarbonate Food Pans

Store, transport and serve all in one pan. Virtually unbreakable polycarbonate will not crack, bend or dent. Withstands temperatures from -40°C to 99°C.



7 SIZES	4 DEPTHS	3 COLORS	7 LID TYPES
------------	-------------	-------------	----------------

Translucent Food Pans

An economical choice for storage and serving. Ideal for use in cold and ambient environments. Withstands temperatures from -40°C to 70°C.



6 SIZES	2 DEPTHS	1 COLOR	4 LID TYPES
------------	-------------	------------	----------------

High Heat H-Pans™

Pans can go from prep to cooler to oven to steam table. Withstands temperatures from -40°C to 190°C.



7 SIZES	3 DEPTHS	2 COLORS	7 LID TYPES
------------	-------------	-------------	----------------

Colander Pans

Liquids drain away from food into the pan below for enhanced food quality and improved food safety.



4 SIZES	2 DEPTHS	2 MATERIALS	3 LID TYPES
------------	-------------	----------------	----------------

Food Pan Lids

Covers protect contents better than plastic wrap or foil while saving time and money. Lids improve food safety and extend product freshness. Fit selected Camwear, High Heat and Poly Food Pans.

Flat Cover

Basic cover available in all pan sizes.



Cover with Handle

Deep molded handle provides secure grip. Available in Black and Clear.



Notched Cover with Handle

Notched cover allows utensils to remain in pan and off of potentially contaminated counters.



FlipLid®

Keeps contents covered yet flips up easily for service.



Notched FlipLid

FlipLid with notch to rest spoon in contents with lid closed.



Seal Cover

Economical cover for all pan sizes. Fits Camwear and High Heat pans.



GripLid®

Lid grips the side of the pan, reducing spills and points of cross contamination. Fits Camwear and High Heat pans.



Seal Cover for Translucent Food Pans

Translucent seal covers provide a tight fit, to protect food quality while eliminating the expense of plastic wrap.



Camwear® Polycarbonate CamSquare® Food Storage Containers



Maximize your storage area with CamSquare food storage containers. The square shape provides 33% better space usage than traditional round containers. Clear polycarbonate provides product visibility for at a glance inventory management. Seal covers feature an inner and outer seal for superior spill resistance, even during transport.

Note: All graduations are approximate.

Dimensions include handles.



Tight fitting Seal Cover is spill resistant, saves expense & safer for employees to handle during transport.

Interstacking saves space when not in use.

Wide molded-in handles ease carrying larger size. Molded-in holes offer quick and sanitary drying.

Crystal clear, virtually unbreakable Camwear polycarbonate withstands temperatures from -40°C to 99°C.

Stain and odor resistant.

Easy to read graduations printed on the outside for quick inventory management.



Seal Covers for Camwear Polycarbonate CamSquare*

- Inner and outer seal provide excellent spill resistance.
- Includes a hole on the corner for hanging during storage.
- Translucent lid easily identifies contents.
- Withstands temperatures from -40°C to 70°C.

* Seal covers only fit Camwear Polycarbonate Square Containers.



CamSquare® Translucent Polypropylene & Polyethylene Food Storage Containers

Translucent Polypropylene

- Translucent material provides some content visibility and high chemical resistance.
- Withstands temperatures from -40°C to 70°C.
- Easy to read graduations are printed on the outside for at a glance inventory management.

Note: All graduations are approximate.



Polyethylene

- Economical storage choice.
- Made of impact, stain and chemical resistant material.
- Withstands temperatures from -40°C to 70°C.

Note: All graduations are approximate.



Covers for CamSquares

- Snap-tight polyethylene covers feature thumb tabs for easy removal.
- Poly covers fit Camwear® Polycarbonate, Translucent and Polyethylene CamSquare Containers.



Personalized Storage Products

Personalize food storage products to identify menu items, add fill lines for recipes, or use personalization in multiple languages to help ensure product quality and consistency.



Camwear® Polycarbonate CamSquare® Food Storage Containers



Camwear® Polycarbonate



CODE	2SFSCW	4SFSCW	6SFSCW	8SFSCW	12SFSCW**	18SFSCW**	22SFSCW**
CAPACITY	1,9 L	3,8 L	5,7 L	7,6 L	11,4 L	17,2 L	20,8 L
DIM. L x W x H	18,5 x 18,5 x 10 cm	18,5 x 18,5 x 18,7 cm	21,5 x 21,5 x 18,5 cm	21,5 x 21,5 x 23 cm	25,6 x 31 x 21 cm	25,6 x 31 x 32 cm	25,6 x 31 x 40 cm
CASE KG (CUBE M³)	1,52 (0,012)	2,40 (0,017)	3,18 (0,028)	3,82 (0,031)	5,42 (0,066)	9 (0,08)	11,5 (0,085)

Case Pack: 6 Color: Clear (135). Height includes covers. ** Dimensions include handles.

Seal Covers for Camwear Polycarbonate CamSquare*



CODE	SFC2SCPP	SFC6SCPP	SFC12SCPP
DESCRIPTION	Fits 1,9 & 3,8 L	Fits 5,7 & 7,6 L	Fits 11,4, 17,2 & 20,8 L
CASE KG (CUBE M³)	0,6 (0,003)	0,71 (0,005)	1,15 (0,007)

Case Pack: 6 Color: Translucent (190).

Note: All graduations are approximate.

* Seal Covers only fit Camwear Polycarbonate CamSquare containers.

Personalization available on non-food contact areas only. See crestring section for information, ordering and pricing.



2

PRORATED

CamSquare® Translucent Polypropylene & Polyethylene Food Storage Containers



Translucent Polypropylene



CODE	2SFSP	4SFSP	6SFSP	8SFSP	12SFSP**	18SFSP**	22SFSP**
CAPACITY	1,9 L	3,8 L	5,7 L	7,6 L	11,4 L	17,2 L	20,8 L
DIM. L x W x H	18,5 x 18,5 x 10 cm	18,5 x 18,5 x 18,7 cm	21,5 x 21,5 x 18,5 cm	21,5 x 21,5 x 23 cm	25,6 x 31 x 21 cm	25,6 x 31 x 32 cm	25,6 x 31 x 40 cm
CASE KG (CUBE M³)	1,18 (0,012)	2,02 (0,017)	2,55 (0,028)	3,11 (0,030)	4 (0,065)	7 (0,08)	8,66 (0,085)

Case Pack: 6 Color: Translucent (190). Height includes covers. ** Dimensions include handles.

Polyethylene



CODE	2SFSP	4SFSP	6SFSP	8SFSP	12SFSP**	18SFSP**	22SFSP**
CAPACITY	1,9 L	3,8 L	5,7 L	7,6 L	11,4 L	17,2 L	20,8 L
DIM. L x W x H	18,5 x 18,5 x 10 cm	18,5 x 18,5 x 18,7 cm	21,5 x 21,5 x 18,5 cm	21,5 x 21,5 x 23 cm	25,6 x 31 x 21 cm	25,6 x 31 x 32 cm	25,6 x 31 x 40 cm
CASE KG (CUBE M³)	1,1 (0,012)	2,04 (0,016)	2,57 (0,026)	3,57 (0,030)	4 (0,065)	7 (0,08)	9 (0,085)

Case Pack: 6 Color: Natural White (148). Height includes covers. ** Dimensions include handles.

Covers*



CODE	SFC2	SFC6	SFC12
COLOR	Kelly Green (452)	Winter Rose (451)	Midnight Blue (453)
DESCRIPTION	Fits 1,9 & 3,8 L	Fits 5,7 & 7,6 L	Fits 11,4, 17,2 & 20,8 L
CASE KG (CUBE M³)	0,6 (0,003)	0,74 (0,005)	1,15 (0,007)

Case Pack: 6

Note: All graduations are approximate.

* Poly Covers fit Camwear®, Translucent and Polyethylene CamSquare Containers.

Personalization available on non-food contact areas only. See cresting section for information, ordering and pricing.



Camwear® Polycarbonate Round Food Storage Containers

Store ingredients or transport ready to serve or partially prepared foods. Clear Camwear polycarbonate allows for easy content identification at a glance. Reduces risk of contamination and enhances food safety. Round shape promotes proper air circulation, ideal for stirring soups and sauces.

Note: All graduations are approximate.

Note: To order Round Food Storage Containers without imprinted graduations, simply add "N" to the end of the code number.

Lids are not interchangeable.



Seal Cover provides excellent spill resistance.

Crystal clear, virtually unbreakable Camwear polycarbonate withstands temperatures from -40°C to 99°C.

Molded-in handles ease carrying. Molded-in holes offer quick and sanitary drying.



Resists food acids, oils & alcohol. Stain and odor resistant.

Interstacking saves space when not in use.

Easy to read graduations on the outside for at a glance inventory management.

Camwear Polycarbonate Covers

- Snap on covers fit tightly.
- Stain resistant to food acids and oils.
- Withstands temperatures from -40°C to 99°C.



Round Seal Covers

- Inner and outer seal provide excellent spill resistance.
- Safe from -40°C to 70°C.
- Thumb tab for easy removal.

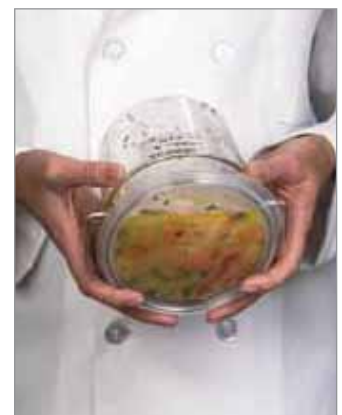

Translucent Polypropylene & Polyethylene Round Food Storage Containers

Translucent Polypropylene

- Translucent material offers some product visibility.
- Rounds are durable and resistant to stains.
- Withstands temperatures from -40°C to 70°C.
- Snap on covers fit tightly to protect contents and extend product freshness.

Note: All graduations are approximate.

Note: To order Round Food Storage Containers without imprinted graduations, simply add "N" to the end of the code number.

Lids are not interchangeable.



StoreSafe

Polyethylene

- Impact, stain and chemical resistant material.
- An affordable storage choice.
- Safe from -40°C to 70°C.
- Snap on covers fit tightly yet are easily removed.

Note: All graduations are approximate.

Note: To order Round Food Storage Containers without imprinted graduations, simply add "N" to the end of the code number.

Lids are not interchangeable.



StoreSafe

Camwear® Polycarbonate Round Storage Containers



Camwear Polycarbonate



CODE	RFSCW1	RFSCW2	RFSCW4	RFSCW6	RFSCW8	RFSCW12	RFSCW18	RFSCW22
CAPACITY	0,9 L	1,9 L	3,8 L	5,7 L	7,6 L	11,4 L	17,2 L	20,8 L
TOP DIAMETER	15,4 cm	20,8 cm	20,8 cm	25,2 cm	25,2 cm	37,8 cm	37,8 cm	37,8 cm
HEIGHT	12,7 cm	11,1 cm	21,8 cm	20,2 cm	27,6 cm	21,3 cm	30,5 cm	38,1 cm
CASE PACK	12	12	12	12	12	6	6	6
CASE KG (CUBE M ³)	2 (0,012)	2,98 (0,020)	5 (0,03)	5,6 (0,04)	7 (0,04)	5,23 (0,051)	7,5 (0,074)	8,69 (0,093)

Color: Clear (135). Top diameter dimension includes handle. Height dimension includes cover. Two year warranty on Polycarbonate Rounds.



Camwear Polycarbonate Covers

DESCRIPTION	CASE PACK	CODE	CASE KG (CUBE M ³)
Fits 0,9 L	12	RFSCWC1	0,6 (0,002)
Fits 1,9 L & 3,8 L	12	RFSCWC2	1,3 (0,007)
Fits 5,7 L & 7,6 L	12	RFSCWC6	1,58 (0,009)
Fits 11,4 L, 17,2 L & 20,8 L	6	RFSCWC12	1,9 (0,012)

Color: Clear (135).

Seal Covers for Camwear Polycarbonate Rounds

DESCRIPTION	CASE PACK	CODE	CASE KG (CUBE M ³)
Fits 0,9 L	12	RFS1SCPP	0,47 (0,002)
Fits 1,9 L & 3,8 L	12	RFS2SCPP	0,92 (0,007)
Fits 5,7 L & 7,6 L	12	RFS6SCPP	1,22 (0,0085)
Fits 11,4 L, 17,2 L & 20,8 L	6	RFS12SCPP	1,47 (0,014)

Color: Translucent (190).

Translucent Polypropylene & Polyethylene Round Food Storage Containers



Translucent Polypropylene



CODE	RFS1PP	RFS2PP	RFS4PP	RFS6PP	RFS8PP	RFS12PP	RFS18PP	RFS22PP
CAPACITY	0,9 L	1,9 L	3,8 L	5,7 L	7,6 L	11,4 L	17,2 L	20,8 L
TOP DIAMETER	15,4 cm	20,8 cm	20,8 cm	25,2 cm	25,2 cm	37,8 cm	37,8 cm	37,8 cm
HEIGHT	12,7 cm	11,1 cm	21,8 cm	20,2 cm	27,6 cm	21,3 cm	30,5 cm	38,1 cm
CASE PACK	12	12	12	12	12	6	6	6
CASE KG (CUBE M³)	1,32 (0,013)	1,72 (0,019)	3 (0,03)	4 (0,04)	5,15 (0,040)	3,29 (0,049)	5 (0,074)	1,68 (0,044)

Color: Translucent (190). Top diameter dimension includes handle. Height dimension includes cover.

Polyethylene



CODE	RFS1	RFS2	RFS4	RFS6	RFS8	RFS12	RFS18	RFS22
CAPACITY	0,9 L	1,9 L	3,8 L	5,7 L	7,6 L	11,4 L	17,2 L	20,8 L
TOP DIAMETER	15,4 cm	20,8 cm	20,8 cm	25,2 cm	25,2 cm	37,8 cm	37,8 cm	37,8 cm
HEIGHT	12,7 cm	11,1 cm	21,8 cm	20,2 cm	27,6 cm	21,3 cm	30,5 cm	38,1 cm
CASE PACK	12	12	12	12	12	6	6	6
CASE KG (CUBE M³)	1,39 (0,013)	1,8 (0,02)	3 (0,03)	3,97 (0,038)	5,25 (0,04)	3,5 (0,05)	4,64 (0,070)	6,17 (0,09)

Color: Natural White (148). Top diameter dimension includes handle. Height dimension includes cover.

Covers for Translucent Polypropylene Rounds

DESCRIPTION	CASE PACK	CODE	CASE KG (CUBE M ³)
Fits 0,9 L	12	RFSC1PP	0,27 (0,002)
Fits 1,9 L & 3,8 L	12	RFSC2PP	0,64 (0,004)
Fits 5,7 L & 7,6 L	12	RFSC6PP	1 (0,006)
Fits 11,4 L, 17,2 L & 20,8 L	6	RFSC12PP	1,6 (0,01)

Color: Translucent (190).

Covers for Polyethylene Rounds

DESCRIPTION	CASE PACK	CODE	CASE KG (CUBE M ³)
Fits 0,9 L	12	RFSC1	0,35 (0,002)
Fits 1,9 L & 3,8 L	12	RFSC2	0,65 (0,004)
Fits 5,7 L & 7,6 L	12	RFSC6	1 (0,006)
Fits 11,4 L, 17,2 L & 20,8 L	6	RFSC12	1,7 (0,012)

Color: Natural White (148).

Camwear® Polycarbonate Food Storage Boxes

Eliminate The Hazard Of Cross Contamination.

Extend the freshness of ingredients and eliminate points of cross contamination by transferring product into food boxes at the receiving dock. A safe solution for storing bulk fruits and vegetables. Clear polycarbonate allows visibility for product identification. Snap tight polycarbonate Camwear covers or SlidingLids™, sold separately, won't come off during transportation.

Camwear and Poly Lids are not interchangeable.

SlidingLids are covered by the following U.S. Patents D 447,906 S & 6,540,098 B1.



Molded-in handles ease carrying.

SlidingLid provides easy access.

Withstands temperatures from -40°C to 99°C for use in coolers and freezers.

Crystal clear, durable Camwear polycarbonate allows for easy product identification.

Smooth surface is easy to clean. Stain and odor resistant.

Texturing on bottom of boxes reduces scratching.

Camwear Polycarbonate Flat Lids

- Snap-tight covers won't come off during transport.
- Top molded-in rails for safer, more secure stacking.
- Durable Camwear® polycarbonate is safe from -40°C to 99°C.



Camwear SlidingLids™ fits Camwear Food Storage Boxes

- Lid slides back to easily access contents, minimizing handling.
- Reduces the risk of cross contamination since lid remains on food box.
- Made of virtually unbreakable Camwear polycarbonate.



Camwear® Polycarbonate & Polyethylene Food Storage Boxes

Camwear Polycarbonate ColanderKits™

- A complete food safety system packaged in one carton.
- Store raw meats, fish on ice or bulk produce safely.
- Juices and liquids drip into the food box below for quick and easy disposal.
- Reduces handling and risk of cross contamination.



- Kit consists of 1 each of 18269CW food box, 1 each 18268CLRCW colander, and 1 each 1826SCCW sliding lid.



Camwear® Polycarbonate Colanders

- Enhances food quality and reduces risk of cross contamination.
- Liquids and juices drain directly into food box for improved food safety.
- Ideal for draining fruits and vegetables, thawing meat or poultry, or storing seafood on ice.



Camwear Polycarbonate Drain Shelves

- Lifts contents out of liquids to enhance food quality and freshness.
- Made of virtually unbreakable polycarbonate.
- Camwear drain shelves fit in both Camwear boxes and white poly boxes.



Polyethylene Food Storage Boxes

- Economical choice for storing bulk produce and ingredients.
- Impact, stain and chemical resistant material.
- Withstands temperatures from -40°C to 70°C.



Camwear Polycarbonate Safety Red Food Storage Boxes

- Helps prevent cross-contamination between raw meats and other food products.
- Red color clearly identifies product inside.
- Matching flat cover also available.



Camwear® Polycarbonate Food Storage Boxes



Camwear® Polycarbonate



CODE	18263CW	● 18266CW	18269CW
DIMENSIONS	46 x 66 x 9 cm	46 x 66 x 15 cm	46 x 66 x 23 cm
APPROX. CAPACITY	18,9 L	33,1 L	49,2 L
CASE PACK	6	6	4
CASE KG (CUBE M ³)	9,95 (0,061)	13,63 (0,130)	12,26 (0,126)



CODE	182612CW	182615CW	12183CW	● 12186CW	12189CW
DIMENSIONS	46 x 66 x 30 cm	46 x 66 x 38 cm	30,5 x 46 x 9 cm	30,5 x 46 x 15 cm	30,5 x 46 x 23 cm
APPROX. CAPACITY	64,4 L	83,3 L	6,6 L	11,4 L	18 L
CASE PACK	4	3	6	6	6
CASE KG (CUBE M ³)	15,6 (0,157)	16 (0,19)	5,51 (0,029)	7,27 (0,060)	9,27 (0,077)

Colors: Clear (135). ● 18266CW & 12186CW available in: Safety Red (467), Clear (135).

Camwear® Polycarbonate Covers



CODE	● 1826CCW FLAT LID	1826SCCW SLIDINGLID™	● 1218CCW FLAT LID	1218SCCW SLIDINGLID™
DIMENSIONS	45,7 x 66 cm	45,7 x 66 cm	30,5 x 45,7 cm	30,5 x 45,7 cm
CASE KG (CUBE M ³)	7,26 (0,026)	8,63 (0,049)	3,57 (0,014)	4,3 (0,020)

Case Pack: 6 Color: Clear (135). ● 1826CCW & 1218CCW available in: Safety Red (467), Clear (135).

Polyethylene Food Storage Boxes & Camwear® Polycarbonate Accessories



Polyethylene Boxes



CODE	18263P	18266P	18269P
DIMENSIONS	46 x 66 x 9 cm	46 x 66 x 15 cm	46 x 66 x 23 cm
APPROX. CAPACITY	18,9 L	33,1 L	49,2 L
CASE PACK	6	6	6
CASE KG (CUBE M³)	7,36 (0,061)	13,04 (0,121)	14,43 (0,158)



CODE	182612P	182615P	12183P	12186P	12189P
DIMENSIONS	46 x 66 x 30 cm	46 x 66 x 38 cm	30,5 x 46 x 9 cm	30,5 x 46 x 15 cm	30,5 x 46 x 23 cm
APPROX. CAPACITY	64,4 L	83,3 L	6,6 L	11,4 L	18 L
CASE PACK	4	3	6	6	6
CASE KG (CUBE M³)	15,6 (0,157)	12,5 (0,19)	4,27 (0,026)	5,68 (0,056)	7,46 (0,072)

Color: Natural White (148).

Polyethylene Covers



CODE	1826CP FLAT LID	1218CP FLAT LID
DIMENSIONS	45,7 x 66 cm	30,5 x 45,7 cm
CASE KG (CUBE M³)	5,98 (0,026)	2,58 (0,012)

Case Pack: 6 Color: Natural White (148).

Camwear and Poly Lids are not interchangeable.

Accessories



CODE	1826DSCW	1218DSCW	1826CLRCW (12,7 CM DEEP)	18268CLRCW (20 CM DEEP)	18268CLRKIT
DESCRIPTION	Drain Shelf	Drain Shelf	Colander	Colander	ColanderKit™
DIMENSIONS	Fits 46 x 66 cm Food Storage Boxes	Fits 30,5 x 46 cm Food Storage Boxes	Fits Camwear Food Storage Boxes 46 x 66 x 15 cm and deeper	Fits Camwear Food Storage Boxes 46 x 66 x 23 and deeper	One 20 cm Deep Colander One 46 x 66 x 23 cm Food Box One 46 x 66 cm SlidingLid™
CASE PACK	6	6	6	4	1 Kit
CASE KG (CUBE M³)	4,95 (0,026)	1,3 (0,01)	13 (0,07)	10,99 (0,093)	7,58 (0,086)

Color: Clear (135).

Camwear® Polycarbonate Food Pans

Store, transport and serve all in one pan. Camwear food pans are made from durable polycarbonate that will not crack, bend or dent. Precisely designed to Gastronorm GN specifications, with a bottom to reduce food waste. At half the cost of stainless steel, Camwear polycarbonate pans keep contents as cold as metal pans with less condensation. Pans stack neatly without wedging or sticking.

Camwear Polycarbonate GN pans are not recommended for steam table or microwave use. See H-Pan™ section for these high heat applications.

Colander Pan is covered by U.S. Patent D 528,376 S.



Uniform 1,27 cm flange ensures a smooth fit in prep tables and food bars.

Virtually unbreakable Camwear® polycarbonate withstands temperatures from -40°C to 99°C.

Molded-in graduations in standard and metric for easy inventory management.



Won't react with food; minimizes potentially hazardous chemical or acidic reaction.

Non-stick smooth interior surface increases yields and promotes easy cleaning.

Textured bottoms resist scratching.



Cold Test

Tests prove Camwear food pans keep products as cold as stainless steel. Stainless steel may feel colder, but as these test results demonstrate, Camwear food pans keep products just as cold for just as long.

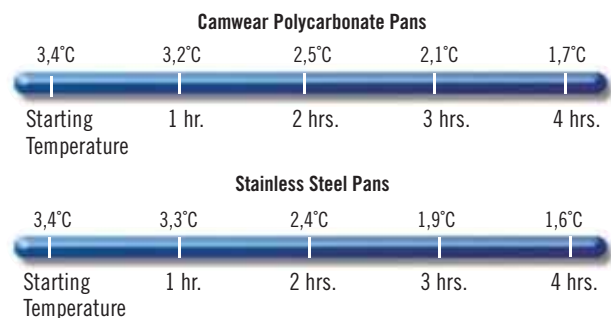

Camwear® Polycarbonate Gastronorm Food Pans Size, & Ordering Information

FULL SIZE

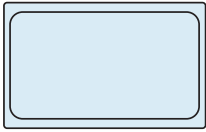

CONFIGURATIONS	PAN CODE	PAN DEPTH	APPROXIMATE CAPACITY	CASE KG (CUBE M ³)
GN 1/1 32,5 x 53 cm	12CW	6,5 cm	8,5 L	5 (0,024)
	14CW	10 cm	13,0 L	6,5 (0,05)
	16CW	15 cm	19,5 L	7,68 (0,059)
	18CW	20 cm	25,6 L	10,4 (0,08)
	10CWD		Drain Shelf	2,51(0,010)

HALF SIZE LONG

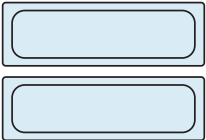

GN 1/2 Long 16,2 x 53 cm	22LPCW	6,5 cm	3 L	2,56 (0,013)
	24LPCW	10 cm	5 L	3,50 (0,026)
	20LPCWD		Drain Shelf	1 (0,005)

HALF SIZE

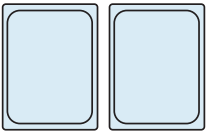

GN 1/2 26,5 x 32,5 cm	22CW	6,5 cm	3,9 L	2,53 (0,020)
	24CW	10 cm	5,9 L	3,19 (0,025)
	26CW	15 cm	8,9 L	4,28 (0,032)
	28CW	20 cm	11,7 L	5,36 (0,039)
	20CWD		Drain Shelf	1,04 (0,005)

ONE THIRD SIZE

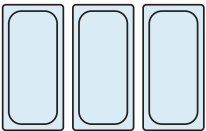

GN 1/3 17,6 x 32,5 cm	32CW	6,5 cm	2,4 L	1,88 (0,013)
	34CW	10 cm	3,6 L	2,5 (0,02)
	36CW	15 cm	5,3 L	3,07 (0,021)
	38CW	20 cm	6,9 L	4 (0,026)
	30CWD		Drain Shelf	0,58 (0,002)

QUARTER SIZE



GN 1/4 16,2 x 26,5 cm	42CW	6,5 cm	1,7 L	1,35 (0,009)
	44CW	10 cm	2,5 L	1,70 (0,012)
	46CW	15 cm	3,7 L	2,4 (0,017)
	40CWD		Drain Shelf	0,40 (0,002)

ONE SIXTH SIZE



GN 1/6 16,2 x 17,6 cm	62CW	6,5 cm	1 L	0,93 (0,007)
	64CW	10 cm	1,5 L	1,18 (0,009)
	66CW	15 cm	2,2 L	1,52 (0,011)
	60CWD		Drain Shelf	0,26 (0,001)

ONE NINTH SIZE



GN 1/9 10,8 x 17,6 cm	92CW	6,5 cm	0,57 L	0,63 (0,004)
	94CW	10 cm	0,85 L	1 (0,006)
	90CWD		Drain Shelf	0,20 (0,001)

Case Pack for all Pans: 6. Lids listed on following page.
See next page for colanders.



Colors: Clear (135), White (148), Black (110). 18CW and 28CW available in Clear (135) only.

Drain Shelf Color: Clear (135).
Colander Color: Clear (135).

All Camwear Polycarbonate GN Food Pans are made of FDA approved materials. All Camwear Polycarbonate GN Food Pans are designed to CEN Gastronorm Standard EN 631-1.

Personalization available on non-food contact areas only. See crestring section for information and ordering.



2
PRORATED

Drain Shelves

- Support products and promotes drainage.
- Available to fit all pan sizes.

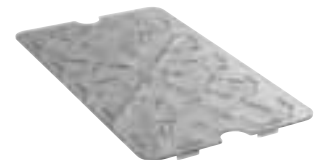

Camwear® Polycarbonate Colander Pans

- Rinse, drain and store all in one pan.
- Liquids drain easily into the food pan below for enhanced food quality and reduced handling.
- Colanders simply lift out of the food pan for safe and quick disposal of liquids.
- Ideal for prepped produce, storing seafood on ice, and defrosting and storing meats and poultry.
- Camwear polycarbonate flat covers, covers with handles and notched covers with handles fit on pans with colanders.

Colander Pans are covered by U.S. Patent D 569,169 S.



13CLRCW



Rinse



Drain



Store

CONFIGURATIONS	PAN CODE	COLANDER DEPTH	FITS CAMWEAR PAN DEPTH*	CASE KG (CUBE M ³)
GN½ 32,5 x 53 cm	13CLRCW	7,6 cm	10 cm	4,88 (0,043)
	15CLRCW	12,7 cm	15 cm	6,53 (0,06)
GN½ 26,5 x 32,5 cm	23CLRCW	7,6 cm	10 cm	2,27 (0,022)
	25CLRCW	12,7 cm	15 cm	3,54 (0,028)
GN½ 17,6 x 32,5 cm	33CLRCW	7,6 cm	10 cm	1,09 (0,015)
	35CLRCW	12,7 cm	15 cm	1,12 (0,019)
GN¼ 16,2 x 17,6 cm	63CLRCW	7,6 cm	10 cm	1,02 (0,008)
	65CLRCW	12,7 cm	15 cm	1,05 (0,009)

Case Pack for all Pans: 6 Lids listed on following page. * Fits this pan depth & deeper.



Camwear® Polycarbonate Lid Sizes & Ordering Information

Flat Cover

Available in all pan sizes.



FITS PANS	LID CODE	DESCRIPTION	CASE KG (CUBE M ³)
GN ¹ / ₄ 32,5 x 53 cm	10CWC	Flat Cover	3,58 (0,012)
	10CWCH	Cover with Handle	3,85 (0,019)
	10CWCHN	Notched Cover with Handle	3,84 (0,019)
	10CWGL	GripLid	4,84 (0,032)
	10SC	Seal Cover	2,98 (0,012)

Cover with Handle

Deep molded handle provides secure grip. Also available in black to help block light, reducing discoloration of meats and cheeses. Helps maintain freshness.



GN ¹ / ₂ Long 16,2 x 53 cm	20LPCWC	Flat Cover	2 (0,007)
---	---------	------------	-----------

GN ¹ / ₂ 26,5 x 32,5 cm	20CWC	Flat Cover	0,82 (0,006)
	20CWCH	Cover with Handle	1,74 (0,01)
	20CWCHN	Notched Cover with Handle	1,76 (0,01)
	20CWL	FlipLid	2,45 (0,009)
	20CWLN	Notched FlipLid	2,45 (0,009)
	20CWGL	GripLid	2,60 (0,015)
	20SC	Seal Cover	1,34 (0,006)

Notched Cover with Handle

Easy access for ladles or spoons.



GN ¹ / ₂ 17,6 x 32,5 cm	30CWC	Flat Cover	1,33 (0,004)
	30CWCH	Cover with Handle	1,43 (0,009)
	30CWCHN	Notched Cover with Handle	1,5 (0,009)
	30CWL	FlipLid	1,65 (0,006)
	30CWLN	Notched FlipLid	1,71 (0,006)
	30CWGL	GripLid	1,97 (0,011)
	30SC	Seal Cover	0,82 (0,004)

Seal Cover

An economical option for light storage. Available in all pan size except half size long pans (22LPCW & 24LPCW).



GN ³ / ₄ 16,2 x 26,5 cm	40CWC	Flat Cover	1 (0,003)
	40CWCH	Cover with Handle	0,91 (0,006)
	40CWCHN	Notched Cover with handle	1,04 (0,006)
	40SC	Seal Cover	0,7 (0,003)

FlipLid®

Flip up lid to easily access contents. Food can be held without getting dried out, increasing yields. Reduces points of cross contamination.



GN ⁵ / ₆ 16,2 x 17,6 cm	60CWC	Flat Cover	0,55 (0,002)
	60CWCH	Cover with Handle	0,64 (0,004)
	60CWCHN	Notched Cover with Handle	0,64 (0,005)
	60CWL	FlipLid	0,91 (0,0032)
	60CWLN	Notched FlipLid	0,91 (0,0032)
	60CWGL	GripLid	1,1 (0,006)
	60SC	Seal Cover	0,39 (0,002)

Notched FlipLid

Flip Lid with notch to rest spoon in contents with lid closed.



GN ⁵ / ₆ 10,8 x 17,6 cm	90CWC	Flat Cover	0,38 (0,001)
	90CWCN	Flat Notched Cover	0,41 (0,001)
	90SC	Seal Cover	0,27 (0,001)

Case pack for all lids: 6

GripLid®

Molded-in polyurethane gasket on the lid grips the side of the food pan, reducing spills and points of cross-contamination.



Color: Clear (135).
Seal Cover Color: White (148).
Cover with Handle Colors: Clear (135), Black (110).

Personalization available on non-food contact areas only. See cresting section for information and ordering.

FlipLids are covered by U.S. Patent Des. 420,849,422,838 & 427,012. GripLids are covered by U.S. Patent D 446,076 & Utility Patent 6,273,288 B1.



ENG MET CS / Storage

Gastronorm High Heat H-Pans™

Reduce handling and save expense with one pan that can go from prep to cooler to oven to steam table. H-Pans are designed to Gastronorm GN specifications. Unlike metal pans, H-Pans are safe for use in microwave ovens. Also ideal for heated carts, steam tables and chafing dishes. H-Pans have both standard and metric graduation markings to promote easy inventory management.

Colors: Amber (150), Black (110).

H-Pans are made of FDA approved materials and are designed to CEN Gastronorm Standard EN 631-1. Amber color may vary.

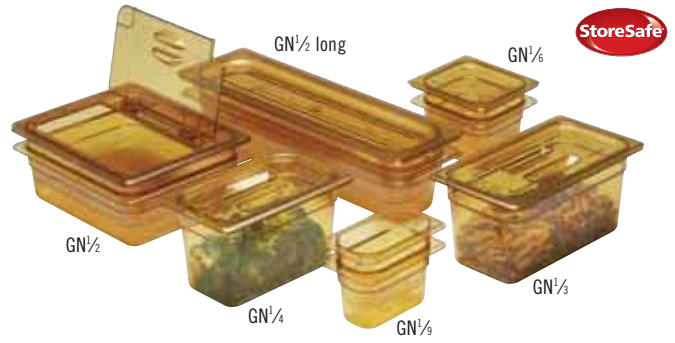

Uniform 1,27 cm flange ensures a smooth fit in prep tables and food bars.

Great for flash freezing, cooking and reheating.

Pans stack neatly, without wedging or sticking.



Non-stick smooth interior surface increases yields and promotes easy cleaning.

Made from FDA approved materials that withstand extreme temperatures from -40°C to 190°C.



Gastronorm High Heat H-Pans™ Sizes & Ordering Information

FULL SIZE

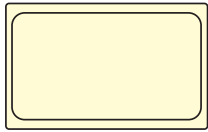

CONFIGURATIONS	PAN CODE	PAN DEPTH	APPROXIMATE CAPACITY	CASE KG (CUBE M³)
GN $\frac{1}{1}$ 32,5 x 53 cm	12HP	6,5 cm	8,5 L	4,93 (0,037)
	14HP	10 cm	13,0 L	6,46 (0,050)
	16HP	15 cm	19,5 L	9 (0,063)
	10HPD	—	Drain Shelf	2,6 (0,01)

Colors: Amber (150), Black (110).
Drain Shelf Color: Amber (150).

H-Pans are made of FDA approved materials and are designed to CEN Gastronorm Standard EN 631-1. Amber color may vary.

Personalization available on non-food contact areas only. See crestring section for information and ordering.



HALF SIZE LONG

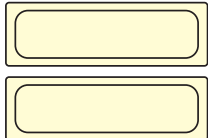

GN $\frac{1}{2}$ Long 16,2 x 53 cm	22LPHP	6,5 cm	3 L	2,64 (0,012)
	24LPHP	10 cm	5 L	3,92 (0,028)
	20LPHPD	—	Drain Shelf	1 (0,005)

HALF SIZE



GN $\frac{1}{2}$ 26,5 x 32,5 cm	22HP	6,5 cm	3,9 L	2,70 (0,019)
	24HP	10 cm	5,9 L	3,57 (0,024)
	26HP	15 cm	8,9 L	4,54 (0,031)
	20HPD	—	Drain Shelf	1,10 (0,005)



ONE THIRD SIZE

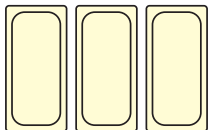

GN $\frac{1}{3}$ 17,6 x 32,5 cm	32HP	6,5 cm	2,4 L	2,2 (0,01)
	34HP	10 cm	3,6 L	2,53 (0,017)
	36HP	15 cm	5,3 L	3,46 (0,021)
	30HPD	—	Drain Shelf	0,62 (0,003)

QUARTER SIZE



GN $\frac{1}{4}$ 16,2 x 26,5 cm	42HP	6,5 cm	1,7 L	1,43 (0,010)
	44HP	10 cm	2,5 L	1,81 (0,014)
	46HP	15 cm	3,7 L	2,51 (0,017)
	40HPD	—	Drain Shelf	0,45 (0,002)

Drain Shelf

- Supports product and promotes drainage.
- Available to fit all food pan sizes.

ONE SIXTH SIZE



GN $\frac{1}{6}$ 16,2 x 17,6 cm	62HP	6,5 cm	1 L	1,29 (0,006)
	64HP	10 cm	1,5 L	1,36 (0,008)
	66HP	15 cm	2,2 L	1,73 (0,011)
	60HPD	—	Drain Shelf	0,27 (0,001)



ONE NINTH SIZE



GN $\frac{1}{9}$ 10,8 x 17,6 cm	92HP	6,5 cm	0,57 L	0,66 (0,004)
	94HP	10 cm	0,85 L	0,84 (0,006)
	90HPD	—	Drain Shelf	0,20 (0,001)

See next page for colanders.

Case Pack: 6 Lids listed on following page.

H-Pan™ Colander Pans

- Colanders drain liquids and grease away from hot foods, improving food quality.
- Ideal for use in microwaves, steam tables and buffet lines.
- Reduces handling and improves food safety.
- H-Pan flat covers, covers with handles and notched covers with handles fit on pans with colanders.



Steam



Hold Hot Foods



Cook & Drain

CONFIGURATIONS	PAN CODE	COLANDER DEPTH	FITS H-PAN DEPTH*	CASE KG (CUBE M ³)
GN $\frac{1}{2}$ 32,5 x 53 cm	13CLRHP	7,6 cm	10 cm	5,14 (0,043)
	15CLRHP	12,7 cm	15 cm	7,02 (0,058)
GN $\frac{1}{2}$ 26,5 x 32,5 cm	23CLRHP	7,6 cm	10 cm	3,20 (0,023)
	25CLRHP	12,7 cm	15 cm	4,20 (0,030)
GN $\frac{1}{2}$ 17,6 x 32,5 cm	33CLRHP	7,6 cm	10 cm	2,08 (0,015)
	35CLRHP	12,7 cm	15 cm	2,81 (0,020)
GN $\frac{1}{2}$ 16,2 x 17,6 cm	63CLRHP	7,6 cm	10 cm	1,09 (0,008)
	65CLRHP	12,7 cm	15 cm	1,41 (0,010)

Case Pack for all Pans: 6. Lids listed on following page. * Fits this pan depth & deeper.



H-Pan with Handles

- Full size 6,5 cm deep food pan with handles fits all leading manufacturers' hot holding bins.
- Two handles allow employees to reach the pan from either side of the unit for safe handling.
- Flat Cover, Cover with Handle and Notched Cover with Handle fit on pan.



12HPH

CONFIGURATIONS	PAN CODE	PAN DEPTH	APPROXIMATE CAPACITY	CASE KG (CUBE M ³)
GN $\frac{1}{2}$ 32,5 x 53 cm	12HPH*	6,5 cm	8,42 L	5,90 (0,044)

Case Pack: 6 Lids listed on following page.

Gastronorm High Heat H-Pan™ Lid Sizes & Ordering Information

Flat Cover

Available in all pan sizes.



FITS PANS	LID CODE	DESCRIPTION	CASE KG (CUBE M ³)
GN $\frac{1}{2}$ 32,5 x 53 cm	10HPC	Flat Cover	4,26 (0,013)
	10HPCH	Cover with Handle	4,04 (0,019)
	10HPCHN	Notched Cover w/Handle	4 (0,018)
	10CWGL	GripLid	4,84 (0,032)
	10SC	Seal Cover	3,2 (0,01)

Cover with Handle

Deep molded handle gives secure grip.



GN $\frac{1}{2}$ Long 16,2 x 53 cm	20LPHPC	Flat Cover	2 (0,007)
---------------------------------------	---------	------------	-----------

GN $\frac{1}{2}$ 26,5 x 32,5 cm	20HPC	Flat Cover	1,75 (0,006)
	20HPCH	Cover with Handle	2,06 (0,010)
	20HPCHN	Notched Cover w/Handle	1,87 (0,009)
	20CWGL	GripLid	2,60 (0,015)
	20HPL	FlipLid	2,49 (0,009)
	20HPLN	Notched FlipLid	2,66 (0,009)
	20SC	Seal Cover	1,34 (0,006)

Notched Cover with Handle

Easy access for ladles or spoons.



GN $\frac{1}{3}$ 17,6 x 32,5 cm	30HPC	Flat Cover	1,18 (0,004)
	30HPCH	Cover with Handle	1,31 (0,008)
	30HPCHN	Notched Cover w/Handle	1,30 (0,008)
	30CWGL	GripLid	1,97 (0,011)
	30HPL	FlipLid	1,81 (0,006)
	30HPLN	Notched FlipLid	1,76 (0,006)
	30SC	Seal Cover	0,82 (0,004)

Seal Cover

An economical option for light storage. Available in all pan sizes except half size long pans (22LPHP & 24LPHP).



GN $\frac{1}{4}$ 16,2 x 26,5 cm	40HPC	Flat Cover	1 (0,003)
	40HPCH	Cover with Handle	1,01 (0,006)
	40HPCHN	Notched Cover w/Handle	1,09 (0,006)
	40SC	Seal Cover	0,73 (0,003)

FlipLid®

Flip up lid to easily access contents. Food can be held without getting dried out, increasing yields.



GN $\frac{1}{6}$ 16,2 x 17,6 cm	60HPC	Flat Cover	0,57 (0,002)
	60HPCH	Cover with Handle	0,64 (0,005)
	60HPCHN	Notched Cover w/Handle	0,68 (0,005)
	60CWGL	GripLid	1,1 (0,006)
	60HPL	FlipLid	1,02 (0,003)
	60HPLN	Notched FlipLid	0,93 (0,003)
	60SC	Seal Cover	0,42 (0,002)

Notched FlipLid®

Flip Lid with notch to rest spoon in contents with lid closed.



GN $\frac{1}{6}$ 10,8 x 17,6 cm	90HPC	Flat Cover	0,84 (0,001)
	90SC	Seal Cover	0,27 (0,001)

Case pack for all lids: 6

GripLid®

Molded-in polyurethane gasket on the lid grips the side of the food pan, reducing spills and points of cross-contamination.



Color: Amber (150).
Seal Cover Color: White (148).
GripLid Color: Clear (135).
Amber color may vary.

.....
Personalization available on non-food contact areas only. See crestring section for information and ordering.
.....

FlipLids are covered by U.S. Patent D 420,849, D 422,838, D 427,012 & D 6,273,288 B1.
.....



Translucent Polypropylene Gastronorm Food Pans

- An economical choice for storing food.
- Translucent polypropylene material provides content visibility and high chemical resistance.
- Withstands temperature ranges from -40°C to 70°C.
- Non-stick smooth interior surfaces promotes easy cleaning.

Color: Translucent (190).

 Graduation marks and capacities are approximate.

 Full Size (GN $\frac{1}{2}$) Translucent Food Pans are not designed for use in front loading carriers UPC400, UPCS400,UPCH4002, UPC600, UPC800, UPCH8002, UPC1200, UPC1600, UPCH1600. Camtherm® Carts or Combo Carts.

 Translucent Food Pans are made of FDA approved materials.

 Translucent Food Pans interstack with other Cambro Food Pans.

 Personalization available on non-food contact areas only. See crestring section for information, ordering and pricing.

 Translucent Pans are not designed for steam table use.



Ideal for transporting in Cambro top loading carriers.

UPC100	UPCS140	100MPC
UPC140	UPCS160	240MPC
UPC160		



Use Cambro StoreSafe® Food Rotation Labels on Translucent Food Pans to manage inventory and reduce waste.

StoreSafe® ID Clips for GN Food Pans

ID clips color coding system fits both lids and pans, preventing cross contamination through incorrect storage of food products. The color clips make it easy to identify food contents during storage, helping foodservice operators comply with HACCP guidelines. Dishwasher safe. Food Pan ID clips fit Polypropylene GN pans.



CASE CODE	FPID24
DESCRIPTION	case of 24 individual bags of 4 sets of 2 clips in yellow, blue, red, green

CASE PACK 24

CASE KG (CUBE M³) 0,45 (0,007)

* Available for ordering in cases only.
 No broken cartons.

Clip Colors:



Translucent Polypropylene Gastronorm Food Pans And Lids Sizes, & Ordering Information

FULL SIZE

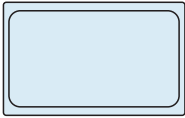

CONFIGURATIONS	PAN CODE	PAN DEPTH	APPROXIMATE CAPACITY	CASE KG (CUBE M ³)
GN $\frac{1}{1}$ 32,5 x 53 cm	14PP	10 cm	13,0 L	3,98 (0,046)
	16PP	15 cm	19,5 L	5,68 (0,066)
	18PP	20 cm	25,6 L	7,73 (0,081)
	10PPD		Drain Shelf	1,90 (0,010)

HALF SIZE

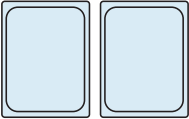

GN $\frac{1}{2}$ 26,5 x 32,5 cm	24PP	10 cm	5,9 L	2,42 (0,024)
	26PP	15 cm	8,9 L	3,54 (0,031)
	28PP	20 cm	11,7 L	4,10 (0,036)
	20PPD		Drain Shelf	0,78 (0,004)

ONE THIRD SIZE

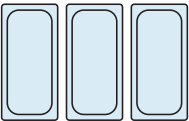

GN $\frac{1}{3}$ 17,6 x 32,5 cm	34PP	10 cm	3,6 L	1,81 (0,016)
	36PP	15 cm	5,3 L	2,27 (0,020)
	30PPD		Drain Shelf	0,46 (0,002)

QUARTER SIZE



GN $\frac{1}{4}$ 16,2 x 26,5 cm	44PP	10 cm	2,5 L	1,19 (0,017)
	46PP	15 cm	3,7 L	1,48 (0,015)
	40PPD		Drain Shelf	0,31 (0,002)

ONE SIXTH SIZE



GN $\frac{1}{6}$ 16,2 x 17,6 cm	64PP	10 cm	1,5 L	0,91 (0,008)
	66PP	15 cm	2,2 L	1,22 (0,011)
	60PPD		Drain Shelf	0,2 (0,0011)

ONE NINTH SIZE



GN $\frac{1}{9}$ 10,8 x 17,6 cm	94PP	10 cm	0,85 L	0,6 (0,006)
	90PPD		Drain Shelf	0,17 (0,001)

Case Pack: 6

Color: Translucent (190).

All Translucent Gastronorm Food Pans are made of FDA approved materials.

Personalization available on non-food contact areas only. See crestring section for information, ordering and pricing.



StoreSafe



Drain Shelf

Available for all food pan sizes.



Cover with Handle

Available for all food pan sizes. Except for GN $\frac{1}{6}$ size.



Notched Cover with Handle

Available for GN $\frac{1}{3}$ and GN $\frac{1}{6}$ food pans.



Seal Cover

Translucent seal covers protect food quality while eliminating the expense of plastic wrap. Available for all pan sizes.



Flat Cover

Only available for GN $\frac{1}{9}$ food pans.



$\frac{1}{1}$



$\frac{1}{2}$



$\frac{1}{3}$



$\frac{1}{4}$

FITS PANS	LID CODE	DESCRIPTION	CASE KG (CUBE M ³)
GN $\frac{1}{1}$ 32,5 x 53 cm	10PPCH	Cover w/ Handle	2,73 (0,016)
	10PPSC	Seal Cover	2,94 (0,023)
GN $\frac{1}{2}$ 26,5 x 32,5 cm	20PPCH	Cover w/ Handle	1,36 (0,010)
	20PPSC	Seal Cover	0,2 (0,01)
GN $\frac{1}{3}$ 17,6 x 32,5 cm	30PPCH	Cover w/ Handle	0,98 (0,008)
	30PPCHN	Notched Cover w/ Handle	0,91 (0,008)
	30PPSC	Seal Cover	0,1 (0,01)
GN $\frac{1}{4}$ 16,2 x 26,5 cm	40PPCH	Cover w/ Handle	0,71 (0,006)
	40PPSC	Seal Cover	0,1 (0,006)
GN $\frac{1}{6}$ 16,2 x 17,6 cm	60PPCH	Cover w/ Handle	0,74 (0,005)
	60PPCHN	Notched Cover w/ Handle	0,48 (0,005)
	60PPSC	Seal Cover	0,5 (0,004)
GN $\frac{1}{9}$ 10,8 x 17,6 cm	90PPC	Flat Cover	0,3 (0,001)
	90PPSC	Seal Cover	0,36 (0,003)

Case Pack for all Lids: 6

Coldfest® Gastronorm Food Pans, Crocks, Covers & Pumps



- Keeps contents chilled at or below HACCP guidelines of 4°C without the use of messy ice.
- Freeze for eight hours or overnight before filling with pre-chilled product.
- Half and third-size pans hold contents cold for up to eight hours. Sixth size pans and crocks hold contents cold for up to six hours.
- Conforms to Gastronorm exterior dimensions to fit standard food bars or make tables.
- Stackable to save space when freezing and storing.
- Can be used for direct food contact with all types of food products.

Colors: Black (110), White (148).

Flat Cover Color: Clear (135).

Seal Cover Color: White (148).

Pump with Cover Color: Clear (135).

Suggested holding times are based on tests with ambient room conditions of up to 23°C.

ColdFest is covered under U.S. Patent D 419,364.

* Pumps and round covers not NSF listed.

All ColdFest GN Food Pans are designed to CEN Gastronorm Standard EN 631-1.



Ideal in Cambro Salad bars or to chill condiments and creamers.

Pans / Crock



CODE	26CF	36CF	66CF	CFR18
CONFIGURATIONS	GN½ – 26,5 x 32,5 cm	GN½ – 17,6 x 32,5 cm	GN½ – 16,2 x 17,6 cm	ø 17,3 cm
DEPTH	15 cm	15 cm	15 cm	17 cm
APPROX. CAPACITY	6 L	3,5 L	1,4 L	1,6 L
CASE KG (CUBE M³)	3,28 (0,015)	2,21 (0,01)	1,21 (0,005)	1,4 (0,0056)

Case Pack: 1



ColdFest Food Pans are made with high-impact resistant ABS shells and non-toxic refrigerant gel cores.

Covers



CODE	20CFC	30CFC	60CFC	CFRC18*	CFRSC18
DESCRIPTION	Flat Cover	Flat Cover	Flat Cover	Flat Cover	Seal Cover
FITS COLDVEST	GN½	GN½	GN½	Crock	Crock
CASE KG (CUBE M³)	0,70 (0,004)	0,47 (0,002)	0,25 (0,0014)	0,2 (0,0008)	0,14 (0,0011)

Case Pack: 2

Pumps with Covers



CODE	CFPSRC10*	CFPMRC10*	CFPFR10*
DESCRIPTION	Standard Pump dispense 29,5 mL portions	Maxi Pump for chunky condiments	Fixed Nozzle Pump for controlled dispensing
DIMENSIONS W x D x H	18,4 x 22,8 x 28,5 cm	18,4 x 26 x 31,4 cm	18,4 x 29,5 x 29,8 cm
CASE KG (CUBE M³)	0,34 (0,003)	0,27 (0,003)	0,34 (0,003)

Case Pack: 1



StoreSafe® Food Rotation Labels

- Label and adhesive dissolve in less than 30 seconds.
- Run under hot or cold water or through the dishwasher.
- Safe for all sewer and septic systems and will not build up in drains.
- Withstands freezing temperatures as low as -40°C.
- Withstands high heat temperatures up to 93°C for 4 hours.
- Microwave safe.
- Leaves behind no sticky residue which can be a breeding ground for bacteria.
- Assists in a proper First In First Out (FIFO) food storage system.
- 100% dissolvable and biodegradable.

Label color: White.

* Available for ordering in cases only.
No broken cartons.

100% biodegradable. FDA approved material.



Eliminates sticky residue and prevents cross contamination! No more scraping!



Dissolves completely off all containers when placed through dishwasher or under running water.



Retail Blister Pack

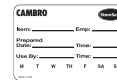

CASE CODE	23SL
LABEL SIZE	5 x 7,6 cm
CASE PACK	20 rolls, 100 labels per roll
CASE KG (CUBE M³)	2,3 (0,03)



Bulk Dispenser Pack – Half Size Labels

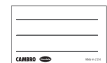

CASE CODE	1252SLB250	1252SLINB250
LABEL SIZE	3 x 5 cm	3 x 5 cm
CASE PACK	24 rolls, 250 labels per roll	24 rolls, 250 labels per roll
CASE KG (CUBE M³)	1,46 (0,007)	2,24 (0,007)

Bulk Dispenser Pack

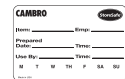
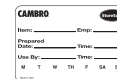

CASE CODE	23SLB250	23SLB6250
LABEL SIZE	5 x 7,6 cm	5 x 7,6 cm
CASE PACK	24 rolls, 250 labels per roll	6 rolls, 250 labels per roll
CASE KG (CUBE M³)	4,81 (0,008)	1,25 (0,003)

Bulk Dispenser Pack – Blank Labels



CASE CODE	23SLINB250
LABEL SIZE	5 x 7,6 cm
CASE PACK	24 rolls, 250 labels per roll
CASE KG (CUBE M³)	4,93 (0,011)

Laser Sheet



BOX CODE	SLL30 (Avery® 5160)
LABEL SIZE	2,54 x 6,35 cm
CASE PACK	100 sheets, 30 labels per sheet 21,6 x 27,9 cm sheet size
CASE KG (CUBE M³)	1,10 (0,002)

Pizza Dough Boxes



DB18263P

Polypropylene

- Ideal for storing, transporting, proofing and cooling dough.
- Lightweight, durable, and break resistant.
- Chemical resistant won't absorb odors and is easy to clean.
- Boxes nest tightly together to keep out dirt and contaminants, extending product freshness.

- The previous box acts as a tight lid for the box below, reducing the need and expense of covers.
- Withstands temperatures from -40°C to 70°C.
- Cover can be used as an 46 cm x 66 cm tray.

Color: White (148).

Polycarbonate & Polypropylene dough boxes do not inter stack

CD1826PDB Color: Coffee Beige (157), Brown(131), Black (110), Slate Blue (401), Grey (180).

* Polypropylene dough boxes are safe for use in high temperature dishwashers.



See Camdolly Section for Camdolly for Pizza Dough Box.

CD1826PDB

Camwear® Polycarbonate

- Prevents crusting to increase the storage life of dough.
- Virtually unbreakable polycarbonate construction is reinforced on all sides.
- Boxes won't bend or lose their shape.

- Withstands temperatures from -40°C to 99°C.
- Available in 7,62 cm and 15,24 cm depths.



DB18266CW

DB18263CW

CODE	OUTSIDE DIMENSIONS	INSIDE DIMENSIONS	CASE KG (CUBE M³)
Polypropylene Pizza Dough Box			
DB18263P	46 x 66 x 7,6 cm	40,6 x 60,9 cm	11,07 (0,152)
Polypropylene Cover			
DBC1826P	46 x 66 cm	—	8,11 (0,064)
Camwear® Polycarbonate Pizza Dough Boxes			
DB18263CW	46 x 66 x 7,6 cm	40,6 x 60,9 cm	10,9 (0,131)
DB18266CW	46 x 66 x 15,3 cm	40,6 x 60,9 cm	16,1 (0,268)
Camwear® Polycarbonate Cover			
DBC1826CW	46 x 66 cm	—	6,72 (0,034)

Case Pack: 6 Color: White (148).

Ingredient Bins & Camcrisper®

Ingredient Bins

- Store bulk dry ingredients such as flour and grain.
- Hygienic clear sliding lid reduces handling and allows for quick content identification.
- Bin made of FDA-accepted material so no liners are needed.
- Designed to fit under standard work tables.

Camcrisper

- A self-contained system for storing, washing and transporting bulk produce.
- Prevents cross contamination and minimizes unnecessary handling.
- Transfer dry produce out of cartons into bin, cover and roll into cooler for safe storage.
- Wash and rinse produce for easy and safe prep.

7,6 cm Casters: 2 fixed, 2 swivel.

Color: White (148).

Scoops sold separately. S-Hook included.



Casters feature wide wheels for excellent stability and weight bearing capability.

Now with Sliding Lid.



CODE	IBS20	IBS27	IBS37	IBSF27
DIMENSIONS W x L x H	33 x 75 x 71 cm	42 x 75 x 71 cm	55 x 75 x 71 cm	33 x 76,5 x 72,5 cm
CAPACITY	81 L	102 L	140 L	102 L
CUBIC METER	0,081	0,102	0,140	0,101
LOAD CAPACITY (SUGAR)	77 Kg	103 Kg	143 Kg	98 Kg
LOAD CAPACITY (FLOUR)	63 Kg	68 Kg	102 Kg	68 Kg
CASE KG (CUBE M ³)	12,7 (0,19)	11 (0,22)	12,7 (0,301)	11,2 (0,196)

Case Pack: 1



CODE	IB32	IB36	IB44	CC32 (Camcrisper)
DIMENSIONS W x L x H	56 x 61 x 58,5 cm	39 x 75 x 74 cm	47 x 75 x 74 cm	56 x 61 x 58,5
CAPACITY	121 L	129 L	161 L	121 L
CUBIC METER	0,123	0,134	0,160	0,123
LOAD CAPACITY (SUGAR)	98 Kg	114 Kg	145 Kg	24 lettuce heads (unfinished)
LOAD CAPACITY (FLOUR)	73 Kg	82 Kg	104 Kg	42 lettuce heads (finished)
CASE KG (CUBE M ³)	13 (0,21)	12,91 (0,216)	13,32 (0,264)	13 (0,217)

Case Pack: 1

Camwear® Polycarbonate Scoops & Measuring Cups

Camwear Polycarbonate Scoops

Color: Clear (135).

Personalization not available.



- Virtually unbreakable Camwear polycarbonate will not dent, chip or rust.
- Molded-in sure grip handle includes a hole for hanging.
- Ideal for use with Cambro Ice Caddies and Ingredient Bins.

CODE	APPROXIMATE CAPACITY	CASE PACK	CASE KG (CUBE M ³)
SCP6CW	170 g	12	3,13 (0,006)
SCP12CW	340 g	12	1,31 (0,008)
SCP24CW	680 g	12	1,76 (0,012)
SCP64CW	1814 g	6	1,88 (0,019)



Camwear Polycarbonate Measuring Cups

Color: Clear (135).

Personalization available on non-food contact areas only. See cresting section for information and ordering.



- Externally marked graduations are molded in and imprinted in red for American standard and blue for metric for easy measurement.
- Durable, virtually unbreakable Camwear polycarbonate will not dent, ensuring an accurate measurement every time.
- Molded-in handle will not break off.

CODE	CAPACITY	CASE PACK	CASE KG (CUBE M ³)
25MCCW	225 mL (dry measure)	12	0,8 (0,008)
50MCCW	0,5 L	12	2,17 (0,019)
100MCCW	1 L	12	3,2 (0,03)
200MCCW	2 L	12	4,81 (0,064)
400MCCW	4 L	1	0,71 (0,012)



Graduations are molded-in and imprinted in Blue for metric and Red for standard American measurements.

MOBILE VENDING EQUIPMENT



Versa Food Service System

The Versa Food Service System provides custom design without the custom price. This stylish, completely portable system goes anywhere and keeps food cold with either ColdFest® pans or Buffet Camchillers®. Whether it's space considerations, frequent menu changes or merchandising requirements, the Versa Food Service System offers unequalled versatility.

- Ergonomic design with enhanced portability.
- One person can set-up or knock-down the sneeze guards and tray rails for transport or storage in only 30 seconds.
- All-weather material is durable and easy to clean.
- Countless configurations to fit any food service need.
- Easily fits through a standard 91,5 cm doorway with the sneeze guards and tray rails knocked down. Knocked down width: 83 cm.
- Ergonomic, molded-in handles on both sides ensure easy maneuvering.
- Design provides new merchandising options.
- All components are fully compliant with NSF requirements.



Shown with optional Tray Rails, End Table, Heavy Duty Casters and Food Pans.

VBRHD6



Versa Work Table

152 or 183 cm

This multipurpose table is perfect as a display or self-serve station for beverages or packaged foods. Use with or without well covers.



Versa Straight Connector

Easily and safely attach multiple components together to create a contiguous system. Use to connect multiple Versa Food Bars, Versa Work Tables or a combination.



Versa Corner Connector

Maximize space and merchandising options. Use to connect multiple Versa Food Bars, Versa Work Tables or a combination.



Sneeze Guards Are Compliant With Current NSF Requirements



Buffet Camchillers®

Extend safe, cold holding time without ice. Dual-sided Buffet Camchillers hold 6,5 cm and 10 cm pans. Fits in the Versa Food Bar® and Versa Work Table.



Versa Cart

Holds electrical equipment such as a computer or check-out terminal. Adjustable shelf can hold a printer. Front panel makes electrical access convenient and the security cable anchor keeps electronics protected. Tray rails easily adjust to a lower height.



Versa Cart Keyboard Tray

Convenient, pull-out keyboard tray improves ergonomics and fits inside the standard lockable drawer.



Versa Food Bar® Lighting Package

Enhance your foodservice presentation with the LED lighting accessory. Available in long-lasting battery model or plug-in model. Contact your Cambro representative for more information.

Versa Food Service System



Whether you're looking to maximize space, improve traffic flow, add merchandising space or create an upscale salad bar, the Versa Food Service System has you covered.

Set-up or knock-down the sneeze guard and tray rails in seconds for easy transport or storage!



Versa Food Bar®

152 or 183 cm

The main component of the system is versatile and mobile. Knock-down sneeze guards allow for easy cleaning and set-up. Add an end table to hold trays or plates.

Shown with optional Tray Rails, End Table, Heavy Duty Casters and Food Pans.



Standard height model.

CODE	DESCRIPTION	OVERALL EXTERIOR DIMENSIONS L x W x H	FULL PAN SIZE CAPACITY	WELL INTERIOR DIMENSIONS L x W x H	CASE KG (CUBE M ³)
Versa Food Bars – Standard Height					
VBR5	152 cm with Standard Casters	175,3 x 108 x 159,4 cm	4	132,8 x 53,3 x 18 cm	85,47 (1,10)
VBRHD5	152 cm with Heavy Duty Casters	175,3 x 108 x 159,4 cm	4	132,8 x 53,3 x 18 cm	88,57 (1,10)
VBR6	183 cm with Standard Casters	208,3 x 108 x 159,4 cm	5	165,4 x 53,3 x 18 cm	99,47 (1,30)
VBRHD6	183 cm with Heavy Duty Casters	208,3 x 108 x 159,4 cm	5	165,4 x 53,3 x 18 cm	104,27 (1,30)
Versa Food Bars – Low Height					
VBRL5	152 cm with Standard Casters	175,3 x 108 x 141,6 cm	4	132,8 x 53,3 x 18 cm	79,5 (1,10)
VBRLHD5	152 cm with Heavy Duty Casters	175,3 x 108 x 141,6 cm	4	132,8 x 53,3 x 18 cm	82,7 (1,10)
VBRL6	183 cm with Standard Casters	208,3 x 108 x 141,6 cm	5	165,4 x 53,3 x 18 cm	92 (1,30)
VBRLHD6	183 cm with Heavy Duty Casters	208,3 x 108 x 141,6 cm	5	165,4 x 53,3 x 18 cm	96,8 (1,30)
Versa Work Tables – Standard Height					
VBRT5	152 cm with Standard Casters	175,3 x 68,9 x 92 cm	4	132,8 x 53,3 x 18 cm	56,87 (0,67)
VBRTHD5	152 cm with Heavy Duty Casters	175,3 x 68,9 x 92 cm	4	132,8 x 53,3 x 18 cm	61,57 (0,67)
VBRT6	183 cm with Standard Casters	208,3 x 68,9 x 92 cm	5	165,4 x 53,3 x 18 cm	64,77 (0,79)
VBRTHD6	183 cm with Heavy Duty Casters	208,3 x 68,9 x 92 cm	5	165,4 x 53,3 x 18 cm	69,57 (0,79)
Versa Work Tables – Low Height					
VBRTL5	152 cm with Standard Casters	175,3 x 68,9 x 74,3 cm	4	132,8 x 53,3 x 18 cm	50,9 (0,67)
VBRTLHD5	152 cm with Heavy Duty Casters	175,3 x 68,9 x 74,3 cm	4	132,8 x 53,3 x 18 cm	55,7 (0,67)
VBRTL6	183 cm with Standard Casters	208,3 x 68,9 x 74,3 cm	5	165,4 x 53,3 x 18 cm	58,9 (0,79)
VBRTLHD6	183 cm with Heavy Duty Casters	208,3 x 68,9 x 74,3 cm	5	165,4 x 53,3 x 18 cm	63,6 (0,79)

Case Pack: 1

Versa Food Service System

CODE	DESCRIPTION	OVERALL EXTERIOR DIMENSIONS L x W x H	CASE LBS. (CUBE M ³)
Versa Cart			
VCSWR	With Dual Tray Rails and Standard Casters	134 x 81,9 x 109,2 cm	57,8 (1,05)
VCSWRHD	With Dual Tray Rails and Heavy Duty Casters	134 x 81,9 x 109,2 cm	62,9 (1,05)
VCS	With Standard Casters and no Tray Rails	81,9 x 81,3 x 109,2 cm	53,4 (1,05)
VCSHD	With Heavy Duty Casters and no Tray Rails	81,9 x 81,3 x 109,2 cm	58,6 (1,05)
Connectors			
VBRC	Straight Connector - Bar to Bar	68,6 x 48,3 x 10,8 cm	4,81 (0,04)
VBRC90	Corner Connector - Bar to Bar	91,4 x 91,4 x 10,8 cm	9,7 (0,10)
VCS32CNT	Connector - Cart to Standard Height Bar / Table	68,58 x 51,75 x 8,26 cm	4,09 (0,03)
VCSCNL	Connector - Cart to Low Height Bar / Table	68,58 x 51,75 x 21,59 cm	6,65 (0,07)

Case Pack: 1



Colors:

Versa Food Bar, Versa Work Table, Cart Colors: Black (110).

Made to order Colors: Bronze (146), Hot Red (158), Navy Blue (186), Kentucky Green (519).

Versa Cart Tray Rail Colors: Granite Gray (191), Sandstone (614).

Tray Rails & End Table Colors: Granite Gray (191), Sandstone (614).

Connector Colors: Black (110), Bronze (146), Hot Red (158), Navy Blue (186), Kentucky Green (519).

Merchandising Color: Clear (152).

Keyboard Tray Color: Black (110).

Versa Food Bar is covered under U.S. Patent D 615,323 S and D 620,730. All other parts patent pending.

Granite Gray (191) is the standard color for rails. Bronze (146) colored food bars, tables and carts have Sandstone (614) rails.



Cart Colors

110	Black	186	Navy Blue
146	Bronze	519	Kentucky Green
158	Hot Red		

Tray Rail Colors

191	Granite Gray	614	Sandstone
-----	--------------	-----	-----------

Table Top Food Bars, Buffet Bars & Ultra Bars



Table Top Food Bars

- Turn a 4'-6' (122-183 cm) table into a double-sided self service buffet or beverage station.
- Thick, foam-insulated ice well holds ice for hours.
- Drain plug allows quick and easy clean-up.



4FBRTT Table Top Food Bar



BUF48 Buffet Bar Base

Merchandises soft drinks on ice to increase beverage sales.

Buffet Bars

- Ideal for holding snacks and cold beverages.
- The Buffet Bar with Sneeze Guard is perfect for single-sided, self-serve buffets.



FSG480 Sneeze Guard

The Free Standing Sneeze Guard is the perfect showcase for salad or dessert items.



BBR480 Buffet Bar with Sneeze Guard

Ultra Bars

- Feature a protected storage cabinet below for extra trays and supplies.
- Sliding doors on both sides provide easy access to storage area.



Ultra Bars: GUBR, 5UBR
End Table Height: 86 cm
Tray Rail Height: 88 cm
12,7 cm Casters: 4 swivel with brake

Shown with optional End Tables, Tray Rails, Crock and Salad Bowl Holders.



FBRTBL, End Table down.

CODE	OVERALL EXTERIOR DIMENSIONS	FULL SIZE PAN CAPACITY	WELL INTERIOR DIMENSIONS	CASE KG. (M ³)
Table Top Model Food Bars				
	L x W x H		L x W x D	
6FBRTT	183 x 85 x 69 cm	5	160 x 51 x 16,5 cm	50,5 (0,49)
5FBRTT	152 x 85 x 69 cm	4	127 x 51 x 16,5 cm	45 (0,455)
4FBRTT	130 x 85 x 69 cm	3	95 x 51 x 16,5 cm	39 (0,455)
Buffet Bars				
	L x W x H		L x W x D	
BUF72	171,5 x 61 x 18 cm	5	160 x 51 x 13 cm	13 (0,185)
BUF48	106 x 61 x 18 cm	5	95 x 51 x 13 cm	9,5 (0,11)
Free Standing Sneeze Guards				
	L x W x H		L x W	
FSG720	188 x 42 x 62 cm		172 x 39 cm	15 (0,19)
FSG480	122 x 42 x 62 cm		107 x 39 cm	11,5 (0,12)
Buffet Bars w/Sneeze Guard				
	L x W x H		L x W x D	
BBR720	188 x 61 x 62 cm	5	160 x 51 x 13 cm	30,5 (0,58)
BBR480	122 x 61 x 62 cm	3	95 x 51 x 13 cm	23 (0,3)
Ultra Food Bars with Cabinet Base				
	L x W x H		L x W x D	
GUBR	183 x 85 x 134 cm	5	160 x 51 x 16,5 cm	160 (42,15)
5UBR	152 x 85 x 134 cm	4	127 x 51 x 16,5 cm	161 (39,50)

Case Pack: 1

www.cambro.com

Food Bar Colors: Black (110), Navy Blue (186), Kentucky Green (519), Hot Red (158).

Crock Holder and Salad Bowl Holders available in White (148), Granite Gray (191), Sandstone (614).



BUF48 and FSG480 can be shipped by parcel carrier.

Food Bar Accessories

Every Accessory You Need

- Crock and Salad Bowl Holders highlight and organize salads, condiments and dressings.
- Tray Rails offer convenience for your patrons.

- Divider Bars securely hold Food Pans in place, providing greater flexibility.
- See Camwear® Food Pans and Crocks section for more information.

Versa Cart Tray Rail Colors:
Granite Gray (191), Sandstone (614).

Versa Food Bar and Cart Rail Colors:
Granite Gray (191), Sandstone (614).

Versa End Table Colors:
Granite Gray (191), Sandstone (614).

Vinyl Cover Color: Opaque (000).

Sign Holder Color: Clear (152).

Buffet Camchiller® Color:
Cold Blue (159).

Divider Bar Colors: White (148), Clear (152).

Well Cover Colors: Black (110), Bronze (146), Hot Red (158), Navy Blue (186), Kentucky Green (519).

Keyboard Tray Color: Black (110).

Crock, Salad Bowl Holders Colors:
White (148), Granite Gray (191), Sandstone (614).

Buffet Camchiller is covered under U.S. Patent D 618, 476 S.

* Items are not NSF Listed.

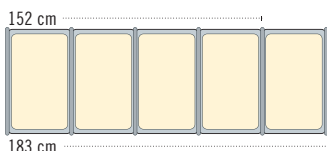

- 183 cm models hold 5 full size Pans with Divider Bars.
- 152 cm models hold 4 full size Pans with Divider Bars.

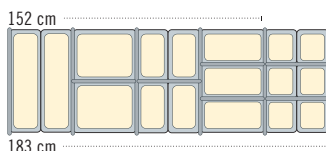

- Fractional Size Pans can be used in many variations with Divider Bars. Mix and match sizes to fit your needs.

Two Salad Bowl Holder models available, SBH18 and SBH15. Crock Holder, CPH3, holds 1,4 L and 2,4 L crocks.

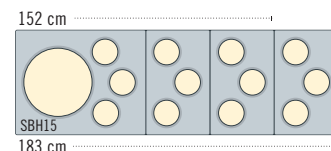
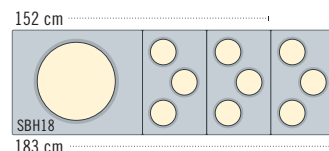

- 183 cm models hold a Salad Bowl Holder and 3 ea. Crock Holders.
- 152 cm models hold a Salad Bowl Holder and 2 ea. Crock Holders.

CODE	DESCRIPTION	OVERALL EXTERIOR DIMENSIONS L x W x H	CASE KG. (M³)	CASE PACK
FBR6R*	Tray Rail for 183 cm - Ultra Food Bar	178 x 20,5 x 4 cm	15 (1,45)	1
FBR5R*	Tray Rail for 152 cm - Ultra Food Bar	162 x 20,5 x 4 cm	14,25 (1,19)	1
VBRR5	Tray Rail for 152 cm - Versa Food Bar	134,6 x 29,2 x 11,6 cm	12,66 (1,81)	1
VBRR6	Tray Rail for 183 cm - Versa Food Bar	167,6 x 29,2 x 11,6 cm	15,57 (2,31)	1
VCS32R	Tray Rail for - Versa Cart	71,12 x 29,7 x 12,7 cm	8,06 (1,09)	1
FBRTBL*	End Table for Ultra Food Bar	41,28 x 53,34 x 11,11 cm		1
VBRTBL	End Table For Versa Bars and Versa Tables	68,58 x 55,88 x 11,43 cm	12,00 (2,55)	1
LED54LIGHTPKG	Lighting Accessory for Versa Food Bar	137 cm		1
VBRCVR5*	Vinyl Cover for 152 cm Versa Food Bar	185,4 x 110,5 x 116,8 cm	3,63 (0,01)	1
VBRCVR6*	Vinyl Cover for Versa Cover for 183 cm Bar	210,8 x 110,5 x 116,8 cm	4,08 (0,01)	1
VBRTCVR5*	Vinyl Cover for Versa Cover for 152 cm Table	177,8 x 85,1 x 53,3 cm	1,1 (0,01)	1
VBRTCVR6*	Vinyl Cover for Versa Cover for 183 cm Table	210,8 x 85,1 x 53,3 cm	2,27 (0,01)	1
VCSCVR*	Vinyl Cover for Versa Cart	106,7 x 83,8 x 91,4 cm	1,59 (0,01)	1
VBRSHTS	Versa Food Bar Sign Holder	91,4 x 15,2 x 23,5 cm	4,1 (0,09)	1
DIV12	30,5 cm Divider Bars	32,5 cm	0,5 (0,001)	3
DIV20	51 cm Divider Bars	53 cm	0,9 (0,003)	3
CPH3	Crock Holder Holds 1,4 & 2,4 L	33 L x 53 W cm	1,3 (0,007)	1
SBH15	Salad Bowl Holder Holds a 38 cm Bowl and 3 Crocks	65,5 L x 53 W cm	2 (0,02)	1
SBH18	Salad Bowl Holder Holds an 45,7 cm Bowl	65,5 L x 53 W cm	2 (0,02)	1
CPB1220	Buffet Camchiller for Versa Food Bar	46,99 x 32,08 x 10,16 cm	4,92 (0,01)	1
VBRWC	Versa Well Cover for Versa Food Bar/Table	53 x 33 x 5 cm	1,69 (0,01)	1
VCS32KEYT	Versa Cart Keyboard Tray	52,4 x 25,71 x 5,08 cm	1,2 (0,01)	1



Sandwiches	\$2.49
Fruit	.69
Salad	1.99
Beverages	1.19



CamKiosk® System — Every event or location is an opportunity for profits.

- Build sales off premise and in non-traditional locations.
- Two insulated food storage cabinets maintain safe hot or cold food and/or beverage temperatures for hours.
- Use Optional Well Covers to cover food pan wells and increase countertop space.
- Durable, all-weather polyethylene exterior with foam insulation will not crack, dent, bubble, chip, rust or break.
- Heavy duty 15,2 cm casters roll smoothly from kitchen to location then lock in place.



KVC854U
Cart w/4 pan wells & umbrella.

CamKiosk® Carts



Telescoping poles enable canopy to lower 30,5 cm for quick and easy storage.



KVC854U Cart w/4 pan wells & canopy.

Cart Colors Canopy Colors

186	Navy Blue	157	Beige
158	Hot Red		
191	Granite Grey	519	Kentucky Green
192	Granite Green		Umbrella Color
519	Kentucky Green		Beige/ Kentucky Green
426	Black Base with Granite Grey Top & Doors		

Personalize your CamKiosk Cart to promote your brand.

CANOPY TRIM AND TOP PANEL

(Charges per side)

One Color	**
Two Color	**
Three Color	**

FRONT DISPLAY PANEL

(Cruising Café® panel standard)

Set Up Charge per Panel	**
Charge per Color	**

** Contact your Cambro representative for pricing.



Conveniently located, lockable cash box (included) can also be kept in dry storage compartment.



Camchillers® keep cold packaged foods cold during transport and service when placed directly on top of food pan wells or at the top of the CamKiosk's insulated holding cabinet.



Bridge connector joins CamKiosk and hand sink to create greater contiguous workspace and under-counter storage.



4 well top



6 well top

CODE	FULL SIZE PAN WELLS	OVERALL DIMENSIONS L x W x H	CASE KG (CUBE M³)
CamKiosk Carts			
KVC854	4	216 x 85 x 179 cm	137 (1,83)
KVC854C	4	216 x 85 x 239 cm	165,11 (2,57)
KVC854U	4	216 x 154 x 251 cm	156 (1,87)
KVC856	6	216 x 85 x 179 cm	138 (1,83)
KVC856C	6	216 x 85 x 239 cm	158 (2,56)
KVC856U	6	216 x 154 x 251 cm	155,67 (2,05)

C: Canopy U: Umbrella

Holding Capacity Per Compartment

Two holding cabinets store hot or cold food in Gastronorm Food Pans with Covers.

- 12 GN $\frac{1}{4}$ full size 6,5 cm deep pans or
- 8 GN $\frac{1}{2}$ full size 10 cm deep pans or
- 6 GN $\frac{3}{4}$ full size 15 cm deep pans or
- 4 GN full size 20 cm deep pans.
- 4 each 2025 Camtrays or
- 8 each 3253 Camtrays.

CODE	DESCRIPTION	DIMENSIONS L x W x H	CASE KG (CUBE M³)	CASE PACK
Optional Accessories				
CB1220	Cutting Board	53,5 x 33,5 x 1,3 cm	1,81 (0,009)	1
CP814	20,32 x 35,56 cm Camchiller®	3,81 x 20,32 x 35,56 cm	0,19 (0,005)	1
CP1220	Camchiller	53 x 33 x 3,8 cm	3,70 (0,009)	1
KMC24	Bridge Connector	82 x 58,5 x 97,5 cm*	15,06 (0,15)	1
WCR1220	Well Cover	53,5 x 33 x 5 cm	2,3 (0,02)	1
1600DIV	ThermoBarrier® Insulated Shelf	53 x 33,5 x 3,8 cm	2,8 (0,015)	2

C: Canopy U: Umbrella

* Assembled dimensions for KMC24.

Well Cover Colors: Black (110), Hot Red (158), Navy Blue (186), Kentucky Green (519), Granite Grey (191), Granite Green (192).

15,24 cm Casters: 2 fixed, 2 swivel, 2 with brake.

Cutting Board Color: White (148).
Camchiller® Color: Cold Blue (159).
ThermoBarrier® Color: Slate Blue (401).



Hand Sink Water Pump, Camchiller & ThermoBarrier.

CamKiosk® Hand Sink Cart, Work Station & Equipment Stand

Hand Sink Cart

- Self-contained, electric hand washing system can be used alone or with CamKiosk Cart.
- Run hot and cold water for up to 70 hand washings.
- Includes: double sinks two 19 L fresh water tanks, two 28,5 L waste-water bins Hand soap dispenser and paper roll holder.
- Durable polyethylene will not crack, dent, bubble, chip or break.
- Hand Sink Cart is designed for hand washing. It contains no filter for purifying water for drinking.
- Faucet is compliant with lead-free regulations.

Colors: Granite Grey (191), Granite Green (192), Navy Blue (186), Hot Red (158), Green (519), Black Base with Granite Grey Top & Doors (426).

15,2 cm Casters: 2 fixed, 2 swivel, 2 with brake.

Hand Sink Cart is covered by U.S. Patent D 409,732 & by Patent 6,173,458 B1.

† 220 volt model includes CEE7 type Euro plug.



Water pump only.



Hand Sink Cart is designed for hand washing. It contains no filter for purifying water for drinking.



Water heater and water pump draw a maximum of 11.25 amps and 0.7 amps, respectively. Hand Sink Cart electrical system runs on an average 10 amps.

ADA faucet available. Contact Cambro Customer Service for information.

CODE	VOLTAGE	DIMENSIONS L x W x H	CASE KG (CUBE M ³)
KSC402	110	103 x 83 x 116 cm	95,24 (1,116)
KSC402220†	220	103 x 83 x 116 cm	95,24 (1,116)

Case Pack: 1

Work Station

- Use to merchandise menu items or to complete sales transactions.
- Large dry storage cabinet below is perfect for holding supplies.
- Paper roll towel dispenser included.
- Extremely durable all-weather polyethylene will not crack, dent, bubble, chip, rust or break.

Colors: Granite Grey (191), Granite Green (192), Navy Blue (186), Hot Red (158), Green (519), Black Base with Granite Grey Top & Doors (426).

15,2 cm Casters: 2 fixed, 2 swivel, 2 with brake.

Top work area dimensions: 57,2 x 66 cm



Work station shown with optional cutting board (CB1220).

CODE	DESCRIPTION	DIMENSIONS L x W x H	CASE KG (CUBE M ³)
KWS40	Work Station	103 x 83 x 116 cm	67,34 (1,116)
CB1220	Cutting Board	53,5 x 33,5 x 1,3 cm	1,81 (0,009)

Case Pack: 1

Equipment Stands

- Perfect for self-serve stations, prep areas or cash register service.
- Counter and side openings for electrical cords and cables.
- Durable, lightweight polyethylene will not crack, dent, bubble, chip, rust or break.
- No assembly required.

Color: Black (110).

12,7 Casters: 2 fixed, 2 swivel with brake.

* Special order item not carried in stock – non-returnable.







Cutaway chair area gives ample space for comfortable seating.

CODE	DESCRIPTION	OVERALL DIMENSIONS W (W/TRAY RAILS) x D x H	CASE KG (CUBE M ³)
ES28	Stand only	71 x 71 x 99 cm	35 (0,54)
ES28RL*	Stand w/Rails on right and left sides of drawer	112 x 71 x 99 cm	38,71 (0,54)

Height includes casters.

Camcruiser® Vending Carts

- Add revenue opportunities away from the kitchen or cafeteria and reduce wait times.
- Durable polyethylene will not crack, dent, bubble, chip, rust or break.
- Display panel can be personalized with a custom logo or message.
- Larger models CVC724 & CVC72 have insulated food storage compartments and full-size food pan wells.
- The compact CVC55 has two open storage compartments, a single food pan well and cutting board.

Cart Color	Umbrella Color
Black (110)	
Hot Red (158)	
Kentucky Green (519)	
Granite Grey (191)	
Granite Green (192)	



CVC724
Open Compartment
Dimensions:
W 33,5 x D 61,5 x H 34 cm

CVC72 & CVC724



CVC724 Four full size food pan wells. Replace with cutting boards or well covers to create additional work space.



CVC72



CVC72 One full size food pan well and 2 larger merchandising wells.



Open holding compartment conveniently stores cash box and tray.

CODE	CVC724	CVC72	CVC55
OVERALL DIMENSION*	L 189 x W 81 x H 239 cm	L 189 x W 81 x H 239 cm	L 140 x W 80 x H 238 cm
WORK COUNTER HEIGHT	93 cm	93 cm	101 cm
COUNTER WELLS HOLD	4 GN $\frac{1}{2}$	Center well, 1 GN $\frac{1}{2}$ 2 outer wells, L 56 x W 39 x D 15 cm	1 GN $\frac{1}{2}$
CLOSED COMPARTMENT CAPACITY (EACH)	2 GN $\frac{1}{2}$ -20 cm + 2 GN $\frac{1}{2}$ -6,5 cm deep pans or 4 GN $\frac{1}{2}$ -15 cm deep pans or 6 GN $\frac{1}{2}$ -10 cm deep pans or 8 GN $\frac{1}{2}$ -6,5 cm deep pans or 4 each 2025 Camtrays or 8 each 3253 Camtrays	2 full size 20 cm + 2 GN $\frac{1}{2}$ -6,5 cm deep pans or 4 GN $\frac{1}{2}$ -15 cm deep pans or 6 GN $\frac{1}{2}$ -10 cm deep pans or 8 GN $\frac{1}{2}$ -6,5 cm deep pans or 4 each 2025 Camtrays or 8 each 3253 Camtrays	—
OPEN COMPARTMENT CAPACITY	1 cash drawer and 1 GN $\frac{1}{2}$ -15 cm deep pan or 2 GN $\frac{1}{2}$ -10 cm deep pans or 3 GN $\frac{1}{2}$ -6,5 cm deep pans	1 cash drawer and 1 GN $\frac{1}{2}$ -15 cm deep pan or 2 GN $\frac{1}{2}$ -10 cm deep pans or 3 GN $\frac{1}{2}$ -6,5 cm deep pans	—
UMBRELLA DIAMETER	183 cm	183 cm	152 cm
CASTERS	20,3 cm - 4 swivel with brake	20,3 cm - 4 swivel with brake	15,2 cm - 2 fixed, 2 swivel with brake
CASH DRAWER	Yes	Yes	—
MENU BOARD	Yes	Yes	—
DISPLAY PANEL	Yes	Yes	Yes
MOLDED IN HANDLES	2	2	1
CASE KG (CUBE M³)	120,47 (2,107)	128 (2,17)	71,51 (1,29)

* Includes Umbrella. Serving counter height is 130 cm.

Camcruiser® Vending Carts



CVC55

Unit ships with umbrella and cutting board. Front display panel can be personalized.

Cutting Board Color: White (148).
Camchiller® Color: Cold Blue (159).
Divider Bar Colors: White (148), Clear (135).
Retainer Strap Color: Black (110).
ThermoBarrier® Color: Slate Blue (401).
 Well Cover Color matches cart.

CVC55 is covered by U.S. Patent D 362,102.



Camchiller, ThermoBarrier, and Divider Bar.



Pizza Camcruiser



Sandwich Camcruiser



Hot Dog Camcruiser



Soft Drink Camcruiser

Display Panel Personalization

Provide complete, finished, camera-ready artwork and indicate positioning on display panel.

Ink colors must be specified. Choose 1-4 colors.

Size of imprinting area:

CVC72 and CVC724

W 53,5 x H 74,5 cm

CVC55 W 112,5 x H 74,5 cm.

Artist's fee of ** net/hour will be charged to any order submitted without camera-ready artwork.

Cambro will contact you prior to completing any work if this fee will be charged.

Set up charge of ** net per design, plus ** net per color.

Allow for three week production lead time once final proofs are approved.

* CVC72 and CVC724 - Campus Cuisine display panel standard with all orders unless custom personalization requested.

** Contact your Cambro representative for pricing.

Compartments are open for storage and easy access to equipment and supplies for your vending operations. Optional retainer strap is sold separately.

Left Compartment Dimensions:

W 61,5 x D 72,5 x H 70 cm

Right Compartment Dimensions:

W 54,5 x D 72,5 x H 70 cm

CVC55



Set up with full and fractional size food pans and divider bars to increase product offerings.



Electrical or soda line conveniently drops through 10 x 17 cm opening in counter. Cover is standard with cart.

CODE	DESCRIPTION	FITS	OVERALL DIMENSIONS L x W x H	CASE KG (CUBE M ³)
Optional Accessories				
CB1220	Cutting Board	CVC724, CVC72, CVC55	53,5 x 33,5 x 1,3 cm	1,81 (0,009)
CP1220	Camchiller®	CVC724, CVC72	53 x 33 x 3,8 cm	3,70 (0,009)
DIV12	Divider Bar	CVC724, CVC72, CVC55	32,5 cm long	0,23 (0,001)
WCR1220	Well Cover	CVC724, CVC72, CVC55	53,5 x 33 x 5 cm	2,3 (0,02)
730STP	Retainer Strap	CVC55	—	0,45 (0,0014)

DIV12 Case Pack: 3 - 1200DIV Case Pack: 2 - All Others Case Pack: 1 Camchiller, ThermoBarrier & Divider Bar are NSF listed.

Booster Seats & Versa Organizers

Booster Seats

- Contoured seat, high sides, wide square base and non-skid surface for toddler comfort and safety.
- Choose from dual or single seat models, with or without strap.
- Durable polyethylene will not crack, dent, bubble, chip, rust or break.

Colors: Black (110), Dark Brown (131), Coffee Beige (157), Navy Blue (186), Kentucky Green (519), Hot Red (158).

No broken cartons on 4 pack.



A Single Seat

B Dual Seat

Dimensions	W x D x H
Overall	29,5 x 28,6 x 20,6 cm
Seat Base	22,2 x 24,7 cm
Inside Seat	24,1 x 24,7 x 10,2 cm

CODE	100BC	100BC1	100BCS
Single Seat			
DESCRIPTION	no strap	no strap	with strap
CASE PACK	4	1	4
CASE KG (CUBE M ³)	4,45 (0,060)	1,28 (0,019)	5,53 (0,059)



Dimensions	W x D x H
Overall	31,6 x 31,1 x 23,8 cm
Seat Base A	31,6 x 31,1 cm
Seat Base B	32,1 x 30,8 cm
Inside Seat A	21 x 24,4 x 8,3 cm
Inside Seat B	27,3 x 27,3 x 12,1 cm

CODE	200BC	200BC1	200BCS
Double Seat			
DESCRIPTION	no strap	no strap	with strap
CASE PACK	4	1	4
CASE KG (CUBE M ³)	7,7 (0,1)	2 (0,03)	7,62 (0,1)

Booster seats are available with or without straps.

Versa Organizers

- Use to store non-perishable condiments, disposable ware and napkins.
- Hold bins in 2 x 3, 2 x 4, 3 x 3, or 3 x 4 arrangements.
- Made of seamless, one-piece polyethylene.
- Set on flat surface or wall mount each bin holds up to 4,5 Kg.
- Easy to assemble and easy to clean.

Bins Only Colors: Coffee Beige (157), Dark Brown (131), Black (110), Slate Blue (401), Speckled Grey (480).

Versa Line Combined Pack Bins & Racks.

Colors: Dark Brown (131), Black (110), Speckled Grey (480).



12RS12 Versa Organizer shown mounted on wall.



Bins sold separately (5412CBP) or as combined packs.



8RS8



6RS6

CODE	DESCRIPTION	PRODUCT DIMENSIONS	CASE PACK	CASE KG (CUBE M ³)
Bins		W x D x H		
5412CBP		13 x 30,5 x 11 cm	12	3,57 (0,05)
Versa Line Combined Pack		L x D x H (complete unit)		
12RS12	Rack w/12 bins	64,8 x 54,3 x 36,2 cm	1	6,70 (0,093)
9RS9	Rack w/9 bins	51,1 x 54,3 x 36,2 cm	1	5,33 (0,075)
8RS8	Rack w/8 bins	64,8 x 48,8 x 24,1 cm	1	4,45 (0,066)
6RS6	Rack w/6 bins	51,1 x 48,8 x 24,1 cm	1	3,56 (0,046)



Portable Cambars®



- Stylish, portable beverage bars for hosting in any environment.
- Select from three systems: economy for bottle and can service, partial or complete soda gun set up systems for pre-mix (canisters) or post-mix (bag-in-box).
- Choose between three sizes.
- Large BAR730 is perfect for banquets and cocktail events.
- Mid-size BAR650 fits into standard elevators and is ideal for small to mid-size functions.
- Small BAR540 is ultra portable for off-premise use and events with limited space.
- All models include speed rail and 36,3 Kg capacity ice sink with cover.*
- Impact-resistant, waterproof polyethylene will not crack, dent, bubble, chip, rust or break.
- Lightweight and portable.
- Easy to take apart and clean, easy to set up.

* BAR540 sink comes uncovered.



THREE SIZES

THREE SYSTEMS

	ECONOMY SYSTEM	BASIC SYSTEM	COMPLETE SYSTEM
	<ul style="list-style-type: none"> • For Bottle, Can, or Mixer Service. • Includes Ice Bin & Speed Rail. • Standard or Designer Decor. 	<ul style="list-style-type: none"> • Partially Equipped for Post or Pre-Mix Soda Service. • Operator Completes Installation. • Standard or Designer Decor. 	<ul style="list-style-type: none"> • Completely Factory Equipped for Post or Pre-Mix Soda Service. • Standard or Designer Decor.
Large BAR730 Models 	Standard Decor BAR730 Designer Decor BAR730DS	Standard Decor BAR730CP Designer Decor BAR730DSCP	Standard Decor BAR730PM, BAR730PMT, BAR730PMT220, BAR730DX Designer Decor BAR730DSPM, BAR730DSPMT, BAR730DSPMT2, BAR730DSDX
Mid-Size BAR650 Models 	Standard Decor BAR650 Designer Decor BAR650DS	Standard Decor BAR650CP Designer Decor BAR650DSCP	Standard Decor BAR650PM, BAR650PMT, BAR650PMT220, BAR650DX Designer Decor BAR650DSPM, BAR650DSPMT, BAR650DSPMT2, BAR650DSDX
Small BAR540 Models 	Standard Decor BAR540 Designer Decor BAR540DS	N/A	N/A

Portable Cambars®

Standard Equipment, Soda Guns, Standard Colors And Designer Decor Packages

STANDARD DECOR EQUIPMENT	ECONOMY			BASIC SYSTEM			COMPLETE SYSTEM POST-MIX (Bag in Box)			COMPLETE SYSTEM PRE-MIX (Canisters)	
	BAR540	BAR650	BAR730	BAR650CP	BAR730CP	BAR650PM	BAR650PMT	BAR730PM	BAR730PMT	BAR650DX	BAR730DX
DESIGNER DECOR EQUIPMENT	BAR540DS	BAR650DS	BAR730DS	BAR650DSCP	BAR730DSCP	BAR650DSPM	BAR650DSPMT	BAR730DSPM	BAR730DSPMT	BAR650SDX	BAR730SDX
Bag In Box Syrup Pumps						3 ea	3 ea	6 ea	6 ea		
Bag In Box Rack (Holds 3ea Boxes)						1	1	2	2		
Carbonator						YES	YES	YES	YES		
CO ₂ Regulator						YES	YES	YES	YES	YES	YES
CO ₂ Clamp & Chain				YES	YES	YES	YES	YES	YES	YES	YES
Ice Sink 8 - Circuit Cold Plate				YES	YES	YES	YES	YES	YES	YES	YES
Ice Sink Cover	Sink only	YES	YES	YES	YES	YES	YES	YES	YES	YES	YES
Retainer Strap		1	2	1	2	1	1	2	2	1	2
Soda Gun (5, 6 or 8 buttons)						5	5	8	8	5	6
Speed Rail (5 or 7 bottle)	5	7	7	7	7	7	7	7	7	7	7
Water Pump							YES		YES		
Water Tank							YES		YES		
Water Line Hook Up (city source)						YES		YES			
Waste Water Bin		YES	YES	YES	YES	YES	YES	YES	YES	YES	YES
Vinyl Cover	YES	YES	YES	YES	YES	YES	YES	YES	YES	YES	YES

Casters: All BAR540 Models - Four 12,7 cm swivel, two with brake. All BAR650 and BAR730 Models - Four 15,24 cm swivel, two with brake.

Soda Guns by Wunder-Bar®

- Fast, low foaming delivery.
- Two year warranty from Wunder-Bar.
- Includes holster with overflow drain.
- Available with complete systems only.



Post-Mix 8 Button
(BAR730 Complete System)



Post-Mix 5 Button
(BAR650 Complete System)



Pre-Mix 6 Button
(BAR730 Complete System)



Pre-Mix 5 Button
(BAR650 Complete System)

Standard and Designer Decor Packages

Standard Decor BAR540, BAR650, BAR730



BAR650, BAR730 Only



BAR540 Only

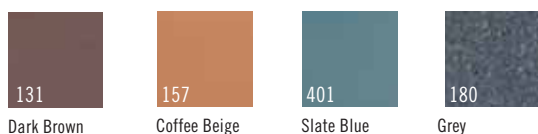

BAR730 & BAR650 Speed Rail Colors: Black (110), Grey Marble (188), Brown Mahogany (189), Granite Grey (191), Granite Sand (194).

BAR540 Speed Rail Colors: Dark Brown (131), Coffee Beige (157), Black (110), Slate Blue (401), Grey (180), Granite Grey (191).

Designer Decor BAR540 Only



BAR650, BAR730 Only

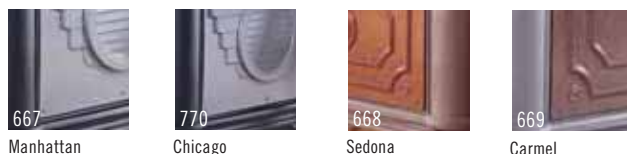

Optional Accessories for CamBars

CODE	DESCRIPTION	CASE KG (CUBE M ³)
650WS	Wire shelf for BAR650's	2,5 (0,034)
730WS	Wire shelf for BAR730's	2,31 (0,042)
730SR	7 Bottle Speed Rail	2,4 (0,037)
BAR54SR	5 Bottle Speed Rail	2,5 (0,037)
650BIBR	Bag in Box Rack (1)	—
730BIBR	Bag in Box Racks (2)	—

Case Pack: 1

Large CamBars® – Complete System BAR730

- Fully Equipped For Service, Post Or Pre-Mix.
- Factory Installed Soda System With Soda Gun.
- With Or Without Water Tank (Post-Mix Only).

Vinyl cover included with all CamBars. Cover not NSF listed.



COMPLETE SYSTEM BAR730 – LARGE MODEL

Post-Mix System For 18,9 L. Bag In Box Syrup.
(Holds up to 6 bag in the box and 1 CO₂ tank.)

Standard Decor

Unit Dimensions: L 184,8 x W 66 x H 121,2 cm

CODE	BAR730PM	BAR730PMT	BAR730PMT220
VOLTS	110	110	220
WATER TANK	NO	YES	YES
UNIT WEIGHT	147 Kg	156 Kg	156 Kg
CASE KG (CUBE M ³)	173 (1,67)	173 (1,67)	173 (1,67)



BAR730DSPMT
(with water tank)

Designer Decor

Unit Dimensions: L 197,2 x W 72,4 x H 120,7 cm

CODE	BAR730DSPM	BAR730DSPMT	BAR730DSPMT2
VOLTS	110	110	220
WATER TANK	NO	YES	YES
UNIT WEIGHT	165 Kg	174 Kg	174 Kg
CASE KG (CUBE M ³)	181 (1,90)	190 (1,90)	190 (1,90)

STANDARD EQUIPMENT FOR BAR730PM & BAR730DSPM:

* Includes all the above plus: 1 each 64,3 liter water tank & 1 each water pump.
Line for city water hook-up not included.

STANDARD EQUIPMENT FOR BAR730PMT, BAR730DSPMT, BAR730PMT220 & BAR730DSPMT2:

1 post-mix soda gun with 8-buttons, 1 sealed-in cold plate, 1 carbonator, 1 CO₂ chain, 1 speed rail (7 bottle), 1 waste water bin, 2 retainer straps, 1 ice sink cover, 2 stainless steel bag in box racks, 6 bag in box pumps, 1 CO₂ regulator and gauge & tubing, hose and lines, 1 Line for city water hook-up.

COMPLETE SYSTEM BAR730 – LARGE MODEL

Pre-Mix System for 18,9 L. Soda Canisters.
(Holds up to 7 canisters and 1 CO₂ tank.)

Standard Decor

Unit Dimensions: L 184,8 x W 66 x H 121,2 cm

CODE	BAR730DX
UNIT WEIGHT	120 Kg
CASE KG (CUBE M ³)	161,57 (1,80)



BAR730DX

Designer Decor

Unit Dimensions: L 197,2 x W 72,4 x H 120,7 cm

CODE	BAR730SDX
UNIT WEIGHT	125 Kg
CASE KG (CUBE M ³)	154 (1,90)

STANDARD EQUIPMENT FOR BAR730DX & BAR730SDX:

1 pre-mix soda gun with 6-buttons, 1 sealed-in cold plate, 1 CO₂ chain, 1 speed rail (7 bottle), 1 waste water bin, 2 retainer straps & 1 ice sink cover.

Large Mobile CamBars® – Basic and Economy Systems

BASIC SYSTEM BAR730 – LARGE MODEL

Standard Decor

Unit Dimensions: L 184,8 x W 66 x H 121,2 cm

CODE	BAR730CP
UNIT WEIGHT	115 Kg
CASE KG (CUBE M³)	132 (1,90)

Designer Decor

Unit Dimensions: L 197,2 x W 72,4 x H 120,7 cm

CODE	BAR730DSCP
UNIT WEIGHT	133 Kg
CASE KG (CUBE M³)	185,52 (1,94)



BAR730DSCP
(Shown with four optional wire racks.)

STANDARD EQUIPMENT FOR BAR730CP & BAR730DSCP:

1 sealed-in cold plate, 1 CO₂ chain, 1 speed rail (7 bottle), 1 waste water bin, 2 retainer straps & 1 ice sink cover.

ECONOMY SYSTEM BAR730 – LARGE MODEL

Standard Decor

Unit Dimensions: L 184,8 x W 66 x H 121,2 cm

CODE	BAR730
UNIT WEIGHT	100 Kg
CASE KG (CUBE M³)	100,85 (1,663)

Designer Decor

Unit Dimensions: L 197,2 x W 72,4 x H 120,7 cm

CODE	BAR730DS
UNIT WEIGHT	105 Kg
CASE KG (CUBE M³)	134 (1,90)



BAR730DS
(Shown with four optional wire racks.)

STANDARD EQUIPMENT FOR BAR730 & BAR730DS:

1 speed rail (7 bottle), 1 waste water bin, 2 retainer straps & 1 ice sink cover.

Mid-Size Mobile Cambars® – Complete System BAR650

- Fully Equipped For Service, Post Or Pre-Mix.
- Factory Installed Soda System With Soda Gun.
- With Or Without Water Tank (Post-Mix Only).

COMPLETE SYSTEM BAR650 – MID-SIZE MODEL

Post-Mix System For 18,9 L. Bag In Box Syrup
(Holds up to 3 bag in the box and 1 CO₂ tank)

Standard Decor

Unit Dimensions: L 171,5 x W 72,4 x H 120,7 cm

CODE	BAR650PM	BAR650PMT*	BAR650PMT220*
VOLTS	110	110	220
WATER TANK	NO	YES	YES
UNIT WEIGHT	152 Kg	161 Kg	152 Kg
CASE KG (CUBE M ³)	164 (1,67)	183,25 (1,95)	173 (1,67)



BAR650DSPMT
(with water tank)

Designer Decor

Unit Dimensions: L 171,5 x W 72,4 x H 120,7 cm

CODE	BAR650DSPM	BAR650DSPMT*	BAR650DSPMT2*
VOLTS	110	110	220
WATER TANK	NO	YES	YES
UNIT WEIGHT	155 Kg	164 Kg	164 Kg
CASE KG (CUBE M ³)	167 (1,67)	176 (1,67)	204,34 (1,687)

STANDARD EQUIPMENT FOR BAR650PM, BAR650DSPM:

1 post-mix soda gun with 5-buttons, 1 sealed-in cold plate, 1 carbonator, 1 CO₂ chain, 1 speed rail (7 bottle), 1 waste water bin, 2 retainer straps, 1 ice sink cover, 1 stainless steel bag in box racks, 3 bag in box pumps, 1 CO₂ regulator and gauge & tubing, hose and lines.

STANDARD EQUIPMENT FOR BAR650PMT, BAR650DSPMT, BAR650PMT2 & BAR650DSPMT2:

* Includes all the above plus: 1 each 64,3 liter water tank & 1 water pump.

COMPLETE SYSTEM BAR650 – MID-SIZE MODEL

Pre-Mix System for 18,9 L. Soda Canisters
(Holds up to 5 canisters and 1 CO₂ tank)

Standard Decor

Unit Dimensions: L 171,5 x W 72,4 x H 120,7 cm

CODE	BAR650DX
UNIT WEIGHT	130 Kg
CASE KG (CUBE M ³)	154,31 (1,50)

Designer Decor

Unit Dimensions: L 171,5 x W 72,4 x H 120,7 cm

CODE	BAR650SDX
UNIT WEIGHT	133 Kg
CASE KG (CUBE M ³)	144 (1,67)



BAR650SDX

STANDARD EQUIPMENT FOR BAR650DX & BAR650SDX:

1 pre-mix soda gun with 5-buttons, 1 sealed-in cold plate, 1 CO₂ chain, 1 speed rail (7 bottle), 1 waste water bin, 2 retainer straps & 1 ice sink cover.

Mid And Small Size Mobile Cambars® – Basic And Economy Systems

BASIC SYSTEM BAR650 – MID-SIZE MODEL

Standard Decor

Unit Dimensions: L 171,5 x W 72,4 x H 120,7 cm

CODE	BAR650CP
UNIT WEIGHT	120 Kg
CASE KG (CUBE M³)	144,45 (1,50)

Designer Decor

Unit Dimensions: L 171,5 x W 72,4 x H 120,7 cm

CODE	BAR650DSCP
UNIT WEIGHT	123 Kg
CASE KG (CUBE M³)	140 (1,67)



BAR650DSCP
(Shown with two optional wire racks.)

STANDARD EQUIPMENT FOR BAR650CP & BAR650DSCP:

1 sealed-in cold plate, 1 CO₂ chain, 1 speed rail (7 bottle), 1 waste water bin, 2 retainer straps & 1 ice sink cover.

ECONOMY SYSTEM BAR650 – MID-SIZE MODEL

For Bottle, Can Or Mixer Service

Standard Decor

Unit Dimensions: L 171,5 x W 72,4 x H 120,7 cm

CODE	BAR650
UNIT WEIGHT	84 Kg
CASE KG (CUBE M³)	96 (1,67)

Designer Decor

Unit Dimensions: L 171,5 x W 72,4 x H 120,7 cm

CODE	BAR650DS
UNIT WEIGHT	87 Kg
CASE KG (CUBE M³)	99 (1,67)



BAR650DS
(shown with two optional wire racks)

STANDARD EQUIPMENT FOR BAR650 & BAR650DS:

1 speed rail (7 bottle), 1 waste water bin, 2 retainer straps & 1 ice sink cover.

ECONOMY SYSTEM BAR540 – SMALL MODEL

Standard Decor

Unit Dimensions: L 137,2 x W 65,7 x H 117,2 cm

CODE	BAR540
UNIT WEIGHT	52 Kg
CASE KG (CUBE M³)	66 (1,12)

Designer Decor

Unit Dimensions: L 137,2 x W 65,7 x H 117,2 cm

CODE	BAR540DS
UNIT WEIGHT	55 Kg
CASE KG (CUBE M³)	66 (1,12)



BAR540DS

STANDARD EQUIPMENT BAR540 & BAR540DS:

1 speed rail (5 bottle).

SlidingLid™ Ice Caddies

- Polyethylene body and thick foam insulation hold ice for days.
- Rugged, all-weather exterior will not crack, dent, bubble, chip, rust or break.
- Unique sliding lid slides back and under during use, reducing risk of cross-contamination.
- Recessed well and drain shelf keep ice out of water, extending holding times.
- Recessed, molded-in handles ease lifting and maneuvering.
- No assembly required.



ICS125L
(Short)



ICS175T
(Tall)



ICS175LB
(Short) Shown with Rear Easy Wheels.



ICS175TB
(Tall) Shown with Rear Easy Wheels.



ICS200TB
(Tall) Shown with Rear Wide Easy Wheels.



ICS100L4S
(Short)

ICS100L
(Short)



These units feature a slant top sliding lid, hold up to 45 Kg. of ice and fit under prep/catering tables, counters or the CamKiosk Bridge.



Colors: Black (110), Slate Blue (401), Dark Brown (131), Coffee Beige (157), Grey (180), Granite Grey (191), Granite Green (192).

SlidingLid Ice Caddies ICS125L, ICS125L4S, ICS125LB are covered by US Patent D 468,071 S. SlidingLid Ice Caddies ICS100L and ICS100L4S are covered by US Patent D 424,883.



Caster Descriptions

(Refers to caster type in chart)

A: 2 fixed, 2 swivel, 1 with brake

A1: 2 swivel, 2 with brakes

B: 4 swivel, 1 with brake

C: 2 swivel, 1 with brake,
2 20,3 cm Easy Wheels

D: 2 swivel, 1 with brake,
2 25,4 cm Easy Wheels

E: 2 swivel, 1 with brake,
2 25,4 cm Wide Easy Wheels



CODE	CAPACITY IN KG	EXTERIOR DIMENSIONS W x D x H	CASTER TYPE	CASE KG (CUBE M ³)
Short				
ICS100L	46	57 x 77 x 73 cm	A1	24,04 (0,327)
ICS100L4S	46	57 x 77 x 73 cm	B	24 (0,3)
ICS125L	57	58,5 x 80 x 74,5 cm	A	27,37 (0,377)
ICS125LB	57	58,5 x 80 x 74,5 cm	C	32,2 (0,37)
ICS175L	80	61 x 95,5 x 74,5 cm	A	35,4 (0,46)
ICS175LB	80	61 x 95,5 x 74,5 cm	D	36,3 (0,46)
Tall				
ICS125T	57	58,5 x 80 x 88 cm	A	32,02(0,44)
ICS175T	80	58,5 x 86,5 x 95,5 cm	A	36,56 (0,51)
ICS175TB	80	58,5 x 86,5 x 95,5 cm	D	37,95 (0,517)
ICS200TB	91	58,5 x 86,5 x 100,5 cm	E	44,5 (0,54)

Case Pack: 1

FOOD HOLDING AND TRANSPORTATION



Camserver® — Holds The Heat For Hours.

- A front-of-house beverage server for hot or cold beverages that does not require canned heating.
- Double-wall polyethylene shell with thick foam insulation retains temperatures for hours.
- Wide nylon latches are easy to open and close with one hand.
- A perfect height for filling large cups or coffee pots.
- Two double-sided, brass snap-on identifier plates included: coffee/ decaf and tea/hot water.

Colors: Black (110), Dark Taupe (417), Granite Grey (191).



Convenient top-fill opening for fast replenishment without removing lid.



CSR5 Shown in Black

CSR3 Shown in Dark Taupe
Height is approximate 18 cm from counter to spigot.



Hot

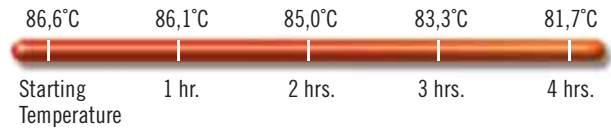

CODE	EXTERNAL DIMENSIONS H x W x D	CAPACITY	210 ML CUPS	CASE PACK	CASE KG (CUBE M³)
CSR3	60 x 34 x 46,5 cm	11,5 L	54	1	8,32 (0,101)
CSR5	71 x 34 x 46,5 cm	19 L	91	1	9,88 (0,114)

Handwash Accessory — For Camtainers® & Ultra Camtainers®



Shown with 500LCD Camtainer®.

- Set up a Handwashing Station quickly and easily on or off premise.
- Convenient and economical way to meet health department hand washing requirements.
- Attaches to Camtainers® 250LCD, 500LCD or Ultra Camtainers® UC250, UC500.
- Includes four Handwash Only labels and an Easy Serve Dispenser lever.

Handwash Accessory Stocking Colors: Dark Brown (131), Black (110).

Easy Serve Dispenser Color: Black (110).

Riser Colors: See optional accessories with Camtainers.

Pail with Bail Color: White (148).

Handwash Accessory is covered by the following U.S. Patent D 506,634 S & D 506,899 S.



CODE	HWAPR	HWATD
DESCRIPTION	With paper towel roll holder	With Multi-Fold Paper Towel Dispenser
FITS	250LCD, 500LCD, UC50, UC500	250LCD, 500LCD, UC50, UC500
CASE KG (CUBE M³)	4,41 (0,058)	4,67 (0,058)

Optional Accessories

CODE	DESCRIPTION	CASE KG (CUBE M³)
R500LCD	Riser	1,5 (0,015)
PWB22	Pail with Bail	6,4 (0,09)
LCDES	Easy Serve	0,5 (—)



Insulated Beverage Containers



- Use to hold, transport and serve hot or cold beverages.
- One piece, seamless double-wall polyethylene with thick foam insulation.
- Sturdy latches secure lids tightly and will never rust.
- Drip-proof recessed spigot for easy self-serve access.
- Stack units on riser to fill large cups or coffee pots.
- Sta-stack interlocking ensures stable stacking during transport and storage.

Easy Serve Dispenser Color: Black (110).

UC250 and UC500 covered by U.S. Patent D 403,917. UC1000 covered by U.S. Patent D 403,916.

Vent Cap patent pending.



350LCD Camtainer not NSF.

Durable and attractive covers extend the life of your Camtainers and fit in any serving environment.

Personalization available. Contact your Cambro representative for details.



Vent Cap

Equalizes pressure. Makes the opening of the container much easier.

E-Z Grip Molded-in Handles

For comfortable, safe transporting.



Recessed Faucet

Accommodates larger cups. Allows even dispensing and eliminates drips. Two positions: one for continuous pouring and one for individual dispensing.



Molded-in Metal Backing Plates

Prevents latches from breaking away from the container.



Ultra Camtainers®

Feature wide nylon latches which are easy to open and close with one hand.



Camtainers®

Feature sturdy plastic latches that secure lids tightly and will never rust.



Stack beverage servers during storage and transporting to save space.

Stacking options:

- 100LCD with 100LCD
- All 250, 350 and 500 units
- UC1000 and 1000LCD

Hot

250LCD	87°C	84,5°C	82°C	79°C	77°C
UC250	88°C	85,5°C	84°C	82°C	80°C
Starting Temperature	1 hr.	2 hrs.	3 hrs.	4 hrs.	

Cold

250LCD	1°C	1,5°C	2°C	3°C	4°C
UC250	0,5°C	1°C	1°C	1,5°C	2°C
Starting Temperature	1 hr.	2 hrs.	3 hrs.	4 hrs.	

Ultra Camtainers®

Choose from three sizes for beverage service. A contemporary line, featuring two wide nylon latches per unit that are easy to open and close.



CODE	UC250	UC500	UC1000
CAPACITY	10,4 L	19,9 L	39,7 L
210 ML. CUPS	50	94	192
EXTERIOR DIMENSIONS	D x W x H 42,5 x 30 x 50 cm	D x W x H 42,5 x 30 x 68 cm	D x W x H 52 x 41,5 x 65,5 cm
FITS CAMDOLLY	CD100, CD100H, CD100HB	CD100, CD100H, CD100HB	CD300, CD300H, CD300HB
CASE KG (CUBE M ³)	6,85 (0,068)	8,55 (0,091)	13,24 (0,148)
CAMTAINER COVER	UC250CVR	UC500CVR	UC1000CVR

Case Pack: 1 Colors: Navy Blue (186), Slate Blue (401), Coffee Beige (157), Dark Brown (131), Brick Red (402), Green (519), Black (110), Granite Grey (191), Granite Green (192), Granite Sand (194). Venting plug is covered by US Patent D 553,717 S.

Camtainers®

The standard for many caterers, choose from four sizes for beverage service and one model without a spigot for soup service. Four sturdy plastic latches on each unit open and close easily and will never rust.



CODE	100LCD	250LCD	500LCD	1000LCD	350LCD (SOUP)
CAPACITY	3,8 L	9,4 L	18 L	44,5 L	12,7 L
210 ML. CUPS	27	45	85	214	60
SPIGOT	YES	YES	YES	YES	—
EXTERIOR DIMENSIONS	D x W x H 29 x 26,5 x 44 cm	D x W x H 42 x 23 x 47 cm	D x W x H 42 x 23 x 62 cm	D x W x H 53 x 41,5 x 63 cm	D x W x H 42 x 23 x 47 cm
FITS CAMDOLLY	—	CD100, CD100H, CD100HB	CD100, CD100H, CD100HB	CD300, CD300H, CD300HB	CD100, CD100H, CD100HB
CASE KG (CUBE M ³)	4,3 (0,04)	5,8 (0,05)	7,3 (0,06)	5,72 (0,149)	6,08 (0,05)
CAMTAINER COVER	—	250LDCVCR	500LDCVCR	1000LDCVCR	—

Case Pack: 1 Colors: Navy Blue (186), Slate Blue (401), Coffee Beige (157), Dark Brown (131), Brick Red (402), Green (519), Black (110), Hot Red (158). Venting plug is covered by US Patent D 553,717 S.

Optional Accessories



CODE	R500LCD	R1000LCD	LCDCH	LCDCH10	LCDES
DESCRIPTION	Riser	Riser	Condiment Holder	Condiment Holder	Easy Serve Dispenser
EXTERIOR DIMENSIONS	D x W x H 41,5 x 23 x 12 cm	D x W x H 49,5 x 39 x 11,5 cm	D x W x H 42 x 22 x 13 cm	D x W x H 51 x 41 x 12 cm	—
FITS	250LCD, 500LCD, UC250, UC500	1000LCD, UC1000	250LCD, 500LCD UC250, UC500	1000LCD, UC1000	LCD Spigots UC Spigots
CASE KG (CUBE M ³)	1,18 (0,014)	2,47 (0,03)	1,16 (0,015)	2,6 (0,03)	0,11 (0,0003)

Case Pack: 1 Colors: Slate Blue (401), Coffee Beige (157), Dark Brown (131), Black (110), Hot Red (158), Granite Grey (191). Easy Serve Color: Black (110)

Insulated Top Loading Camcarriers® To Transport Gastronom Food Pans

- Top-loading food pan carriers hold, transport and serve a single full-size pan of hot or cold food.
- Sturdy and durable, seamless polyethylene or polypropylene with thick foam insulation.
- Molded-in handles on all four sides for easy carrying and handling.
- Use with divider bars to hold multiple fractional pans.
- Pans are easy to remove using finger notches.
- Carriers interlock and stack for transporting and storing.

UPCS Colors: Dark Brown (131), Speckled Grey (480), Coffee Beige (157), Black (110).

MPC and MPCHL Colors: Navy Blue (186), Slate Blue (401), Coffee Beige (157), Dark Brown (131), Brick Red (402), Green (519), Black (110), Hot Red (158).

* Polypropylene dough boxes are safe for use in high temperature dishwashers.

UPC Colors: Slate Blue (401), Coffee Beige (157), Dark Brown (131), Black (110), Granite Grey (191), Granite Green (192), Granite Sand (194).

Camdolly® Colors: Coffee Beige (157), Dark Brown (131), Black (110), Slate Blue (401), Grey (180).

Divider Bar Colors: White (148), Clear (135).

See Food Pan Section for pricing and ordering information.

Note: Place food pans on rails. Pans should not be placed on the floor of a Camcart or Camcarrier® cavity.

Note: If using metal food pans, cool to 120°C before placing into carriers.



UPCS160



Stacking and storage reduced by 35%!



UPCS160

UPC140

UPC160

Shown with dividers and fractional sized food pans.



No divider bars available for UPC100.

Hot

UPC160	87°C	85°C	83°C	81°C	79°C
UPCS160	87°C	85°C	83°C	81°C	79°C
UPCSS160	87°C	85°C	83°C	81°C	79°C

Starting Temperature 1 hr. 2 hrs. 3 hrs. 4 hrs.

Cold

UPC160	0°C	1°C	2°C	2°C	2,5°C
UPCS160	0°C	1°C	2°C	2°C	2,5°C
UPCSS160	0°C	1°C	2°C	2°C	2,5°C

Starting Temperature 1 hr. 2 hrs. 3 hrs. 4 hrs.

Camcarrier®

One-piece, seamless polyethylene construction, airtight removable gasket and sturdy plastic latches.



CODE	240MPC
COMPARTMENT CAPACITY	1 GN½ - 10 cm deep pan
EXTERIOR DIMENSIONS W x D x H	42 x 35 x 19 cm
CASE KG (CUBE M³)	3,95 (0,03)

Case Pack: 1

S-Series

Durable polypropylene construction, built in seal and wide, nylon latches. Contemporary appearance and superior holding performance at an economical price.



CODE	UPCS140	UPCS160	UPCS180	UPCSs160
COMPARTMENT CAPACITY	1 GN $\frac{1}{2}$ - 10 cm deep pan	1 GN $\frac{1}{2}$ - 15 cm deep pan	1 GN $\frac{1}{2}$ - 20 cm deep pan	1 full size 15 cm deep pan
EXTERIOR DIMENSIONS W x D x H	64 x 43,5 x 22 cm	64 x 43,5 x 26 cm	64 x 43,5 x 30,5 cm	62,5 x 42 x 28 cm
FITS CAMDOLLY®	CD160	CD160	CD160	CD160
CASE KG (CUBE M ³)	7,91 (0,067)	8,6 (0,07)	8,88 (0,0094)	7,71 (0,070)

Case Pack: 1 *UPCSS160 available in Dark Brown (131) and Coffee Beige (157).

Ultra Pan

One-piece, seamless polyethylene construction, airtight removable gasket and wide, nylon latches.



CODE	UPC140	UPC160	UPC180
COMPARTMENT CAPACITY	1 GN $\frac{1}{2}$ - 10 cm deep pan	1 GN $\frac{1}{2}$ - 15 cm deep pan	1 GN $\frac{1}{2}$ - 20 cm deep pan
EXTERIOR DIMENSIONS W x D x H	63 x 44 x 21 cm	63 x 44 x 26 cm	63 x 44 x 30,5 cm
FITS CAMDOLLY®	CD160	CD160	CD160
CASE KG (CUBE M ³)	7,53 (0,06)	9,4 (0,08)	9,8 (0,09)

Case Pack: 1

100 Series

Store and stack food pans or place food directly in compartment. The 100MPCHL model has a hinged serving lid.



CODE	100MPC	100MPCHL	100P100	100P101
COMPARTMENT CAPACITY	3 GN $\frac{1}{2}$ - 6,5 cm deep pan or 2 GN $\frac{1}{2}$ - 10 cm deep pans or 1 GN $\frac{1}{2}$ - 15 or 20 cm deep pan	1 GN $\frac{1}{2}$ - 20 cm deep pan	3 GN $\frac{1}{2}$ - 6,5 cm deep pans or 2 GN $\frac{1}{2}$ - 10 cm deep pans or 1 GN $\frac{1}{2}$ - 15 cm or 20 cm deep pan	3 GN $\frac{1}{2}$ - 6,5 cm deep pan or 2 GN $\frac{1}{2}$ - 10 cm deep pans or 1 GN $\frac{1}{2}$ - 15 cm or 20 cm deep pan
	W x D x H	W x D x H	W x D x H	W x D x H
EXTERIOR DIMENSIONS	68 x 45 x 38 cm	68 x 45 x 39,5 cm	68 x 46 x 40 cm	67,5 x 46 x 32 cm
INTERIOR DIMENSIONS	55 x 35 x 20,5 cm	55 x 35 x 20,5 cm	56,5 x 33 x 20,5 cm	55,5 x 33,5 x 21 cm
BULK CAPACITY*	38 L	38 L	38 L	38 L
FITS CAMDOLLY®	CD100, CD100H, CD100HB	CD100, CD100H, CD100HB	CD100, CD100HB	CD100, CD100HB
CASE KG (CUBE M ³)	12,2 (0,13)	13,6 (0,13)	11,43 (0,131)	11 (0,11)

Case Pack: 1 * Without using food pans.

Accessories

CODE	OVERALL EXTERIOR DIMENSIONS	CASE PACK	CASE KG (CUBE M ³)
Divider Bars			
DIV12	32,38 cm (Length)	3	0,45 (0,0006)
DIV20	53,02 cm (Length)	3	0,9 (0,003)

*Not for use in UPCSS1600

Camchiller®, ThermoBarrier® & Camwarmer®



Camchiller

- An easy-to-use, cold food holding temperature tool.
- Extend cold holding time or enhance safe holding below 5°C when frequent access is required.
- Freeze first then use to pre-chill cabinet before loading.

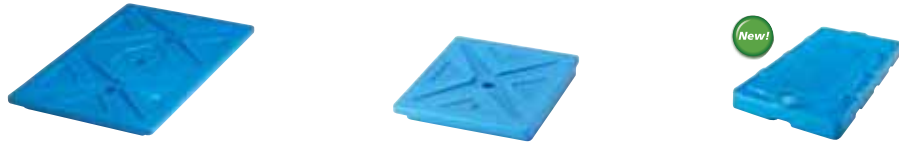
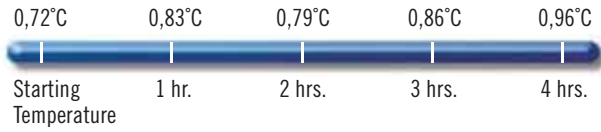

CODE	CP1220 (GN FULL SIZE)	CP1210 (GN HALF SIZE)	CP814 (20 x 36 CAMCHILLER)
FITS INTO	UPCSS160, 300MPC, 1318MTC, UPC400, UPC400TR, UPSC400, UPC600, UPC800, UPC800TR, UPC1200, UPC1600, CVC72, CVC724, CMB1826, CMB1826L, and CamKiosk®*	125MPC, 300MPC, 1318MTC, UPC400, UPSC400, UPC400TR, UPC600, UPC800, UPC800TR, CVC724*, CVC72* and CamKiosk*	12186CW, 12186P, 12189CW, 12189P, CVC724, CVC72, CVC55, and CamKiosk
DIMENSIONS L x W x H	53 x 33 x 3,8 cm	32,4 x 26,4 x 3,8 cm	35,56 x 20,32 x 3,8 cm
QUANTITY PER CAVITY	1 (*2 per cavity)	1 (*2 per top wells)	1
CASE KG (CUBE M³)	3,70 (0,009)	1,7 (0,005)	1,72 (0,005)

Case Pack: 1 Color: Cold Blue (159).

ThermoBarrier

- A highly valuable yet economical temperature maintenance tool for caterers.
- Use to minimize empty space and food temperature loss within a partially loaded compartment.

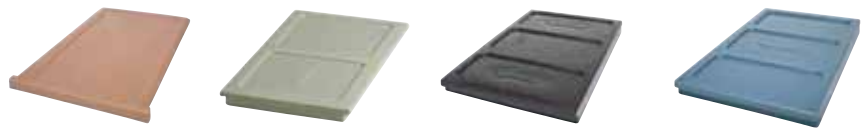

CODE	300DIV	400DIV	1200DIV	1600DIV
FITS INTO	300MPC, UPC600, 1318MTC	UPC400, UPC800, UPC400TR, UPSC400, UPC800TR	UPC1200, CVC72, CVC724	UPC1600, CamKiosk UPC1600TR
QUANTITY PER COMPARTMENT	1	1	2	2
DIM. L x W x H	53 x 33 x 2,5 cm	54 x 33 x 3,8 cm	53 x 33,5 x 3,5 cm	53 x 33,5 x 3,8 cm
COLOR	Coffee Beige (157)	Grey (180)	Dark Brown (131)	Slate Blue (401)
CASE PACK	1	1	2	2
CASE KG (CUBE M³)	1,59 (0,009)	1,63 (0,010)	3,5 (0,02)	2,80 (0,015)

Camwarmer

- Use for added insurance to keep hot foods hot during holding and transporting.
- Keep in cabinet with hot foods to extend holding time or enhance safe holding above 65°C when frequent access is required.



CODE	1210PW
FITS INTO	300MPC, 1318MTC, UPC400, UPC400TR, UPSC400, UPC600, UPC800, UPC800TR
DIMENSIONS L x W x H	34 x 27,5 x 4 cm
CASE PACK	1
CASE KG (CUBE M³)	1,63 (0,005)

Color: Granite Grey (191)



UPC400 with Camwarmer. Two Camwarmers recommended per cavity.

Temperature Maintenance – Optimize Food Holding Performance

Camchiller® – GN¹/₂ Size and GN¹/₂ Size

- Use to:
 - Pre-chill cabinet cavity.
 - Hold package food in food pan wells. (Half Size Only)
 - Maximize cold food holding.
 - Minimize open cavity space.
- Easy to use:
 1. Freeze 8 hours.
 2. Slide one or two on top rails and pre-chill cavity 15-20 minutes.
 3. Load in pans of pre-chilled food below Camchiller. (A)
 4. Move pans and Camchiller down as food is removed. (B)

COLD HOLDING

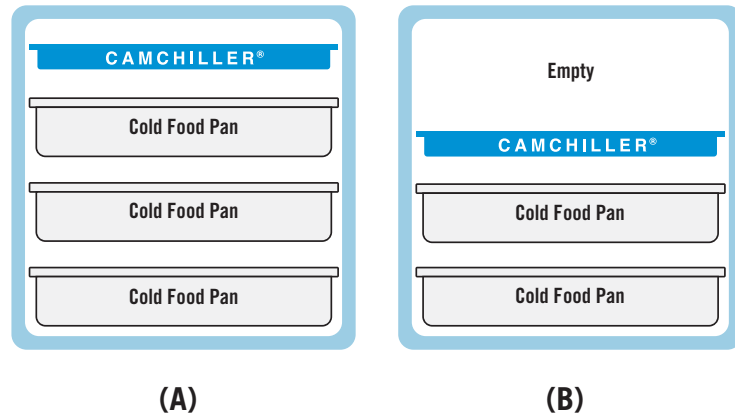

ThermoBarrier® – GN¹/₂ Size

- Use to:
 - Hold hot and cold food in same cabinet cavity.
 - Minimize open cavity space.
- Easy to use:
 1. Slide between hot food on top and cold food on bottom. (A)
 2. Slide under hot food loaded in upper cavity space. (B)
 3. Slide above cold food loaded into lower cavity space. (C)

HOT AND COLD HOLDING

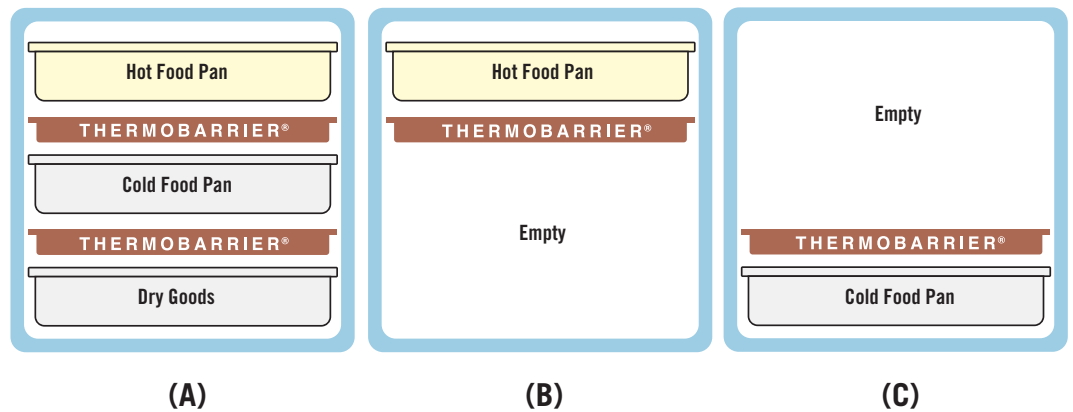

Camwarmer® – GN¹/₂ Size

- Use to:
 - Pre-heat cabinet cavity.
 - Maximize hot food holding.
 - Minimize open cavity space.
- Easy to use:
 1. Heat in 180°C oven for 45 minutes.
 2. Slide two Camwarmers on bottom rails and pre-heat cavity 15-20 minutes. (or place on high heat food pan lid or sheet pan)
 3. Load in pans of pre-heated food above Camwarmers. (A)
 4. Move pans and Camwarmers up as food is removed. (B)

HOT HOLDING

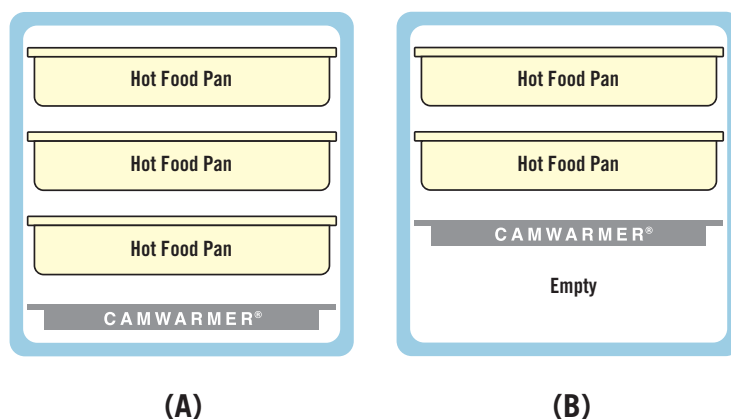

Insulated Front Loading 300MPC & UPC400 To Transport Gastronom Food Pans

- Durable and dependable front-loading food pan carriers.
- Hold multiple pans of hot or cold food at safe temperatures for hours.
- Seamless polyethylene with thick foam insulation.
- Airtight removable gasket provides a secure seal.

300MPC Colors: Navy Blue (186), Slate Blue (401), Coffee Beige (157), Dark Brown (131), Brick Red (402), Green (519), Black (110), Hot Red (158).

UPC400 Colors: Navy Blue (186), Slate Blue (401), Cold Blue (159), Coffee Beige (157), Dark Brown (131), Black (110), Granite Grey (191), Granite Green (192), Granite Sand (194).

▲ Camdolly Colors: Slate Blue (401), Coffee Beige (157), Dark Brown (131), Black (110), Grey (180).

Note: Place food pans on rails. Pans should not be placed on the floor of a Camcarrier® cavity. Please use specified food pan sizes.

Note: If using metal food pans, cool to 120°C before placing onto rails.

See Food Pan section for pricing and ordering information.

UPC400 is covered by US Patent D 392,158.

Venting plug is covered by US Patent D 553,717 S.

*Tamper-resistant models (for correctional industry) use hinge pins that cannot be removed.



Hot

UPC400	87,8°C	85,6°C	84,5°C	82,8°C	81,7°C
300MPC	86°C	83°C	81°C	79°C	77°C
	Starting Temperature	1 hr.	2 hrs.	3 hrs.	4 hrs.

Cold

UPC400	0,3°C	0,8°C	0,9°C	1,2°C	1,4°C
300MPC	1°C	1,5°C	2°C	2,5°C	3°C
	Starting Temperature	1 hr.	2 hrs.	3 hrs.	4 hrs.



CODE	300MPC	UPC400 / UPC400TR**
EXTERIOR DIM. W x D x H	42,5 x 62 x 57 cm	46 x 63,3 x 62 cm
INTERIOR DIM. W* x D x H	34 x 53,5 x 36 cm	33,5 x 53,3 x 49 cm
CASE KG (CUBE M³)	13,69 (0,161)	15,07 (0,198) / 14,97 (0,202)

Case Pack: 1 * Rail to Rail ** Tamper Resistant Model.

HOLDING CAPACITY:

Pan Depth	300MPC	UPC400
6,5 cm	4	6
10 cm	3	4
15 cm	2	3
20 cm	1 + 1 each 6,5 cm	2

Also holds GN 1/2 and 1/3 size pans.

Optional Accessories

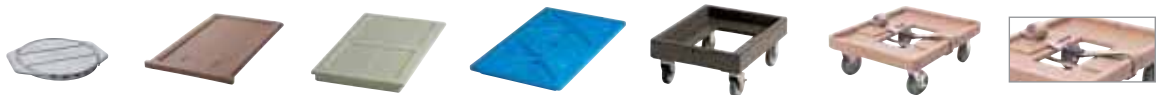

CODE	1210PW	300DIV	400DIV	CP1220	CD300*	CD400	400STP
DESCRIPTION	Camwarmer®	ThermoBarrier®	ThermoBarrier	Camchiller®	Camdolly®	Camdolly	Strap
EXTERIOR DIM. (cm)	34,9 x 27,6 x 4	53 x 33 x 2,5	54 x 33 x 3,8	53 x 33 x 3,8	49 x 65 x 26,5	71 x 53 x 23	500 Long
INTERIOR DIM. (cm)	—	—	—	—	43 x 59	63,5 x 46	—
COLOR	Granite Grey (191)	Coffee Beige (157)	Grey (180)	Cold Blue (159)	▲	▲	Beige (000)
CASE KG. (CUBE M³)	1,63 (0,005)	1,59 (0,009)	1,8 (0,01)	7,9 (0,0107)	8 (0,09)	8,9 (0,095)	1/2 (—)

Case Pack: 1 * Also available CD300H and CD300HB. See Camdolly section.





UPCS400 Ultra Pan Carrier® S-Series To Transport Gastronom Food Pans

- Ultra dependable, ultra durable front-loading pan carrier.
- Holds multiple pans of hot or cold food for hours.
- Durable polyethylene shell and thick, polyurethane foam insulation.

◆ **UPCS400 Colors:** Slate Blue (401), Speckled Grey (480), Dark Brown (131).

▲ **CD400 Colors:** Coffee Beige (157), Dark Brown (131), Black (110), Slate Blue (401), Grey (180).

Casters: 12,7 cm 2 fixed, 2 swivel, 1 with brake.

Note: If using metal food pans, cool to 120°C before placing onto rails.



Stacks with both UPCS400. Fits on CD400 Camdolly, or optional casters may be added for smooth ground transport.

HOLDING CAPACITY:
PAN DEPTH NUMBER OF GN 1/3 PANS

PAN DEPTH	NUMBER OF GN 1/3 PANS
6,5 cm	6
10 cm	4
15 cm	3
20 cm	2

Also holds GN 1/2 and 1/3 size pans.



CONVENIENT
Integrated pan-staging area eases service.

EASY CONTENT AND ROUTING LABELING

Menu clip reduces need to open door (not for use during transport).



ERGONOMIC DESIGN

Unbreakable, ergonomic, molded-in handles for comfortable two-person carrying.

TEMPERATURE RETENTION

Polyurethane insulation keeps hot food hot and cold food cold.



EASY TO CLEAN
Door removes for easy cleaning.

QUICK ACCESS

Single, 23 cm nylon latch for quick and secure opening and closing.



PRESSURE CONTROL

Built-in vent equalizes pressure and releases steam.

BUILT-IN SEAL

Built-in seal eliminates need for removable gasket.

Hot

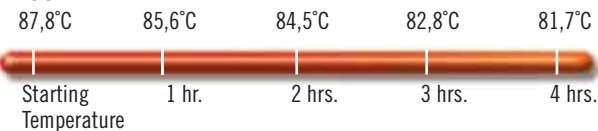

Cold

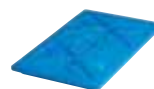
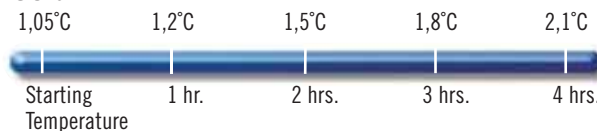

CODE	UPCS400	UPCS400CK	1210PW	400DIV	CP1220	CD400	400STP
DESCRIPTION	Insulated Carrier	Caster Kit*	Camwarmer®	ThermoBarrier	Camchiller	Camdolly®	Strap
EXTERIOR DIM. (cm)	63,5 x 46 x 63	∅ 12,7	34,9 x 27,6 x 4	54 x 33 x 3,8	53 x 33 x 3,8	71 x 53 x 23	500 cm Long
INTERIOR DIM. (cm)	53,5 x 33,5 x 48,6	—	—	—	—	63,5 x 46	—
COLOR	◆	—	Granite Grey (191)	Grey (180)	Cold Blue (159)	▲	Beige (000)
CASE KG. (CUBE M³)	21,55 (0,2)	4,4 (0,007)	1,63 (0,005)	1,8 (0,01)	7,9 (0,0107)	8,9 (0,095)	1/2 (—)

Case Pack: 1 *Optional Caster Kit: 2 fixed, 2 swivel, 1 w/ brake.

Ultra Camcarts® To Transport Gastronom Food Pans



- Double-compartment, high-capacity carts hold and transport hot or cold food.
- Tough, polyethylene shell and thick foam insulation throughout cabinet and between compartments.
- Airtight removable gaskets maintain safe food temperatures for hours.
- Easy to maintain and won't dent, crack, rust, chip or break.
- Durable nylon door latches open easily and close securely.
- Full-swing doors open to the side of the cart for easy loading and unloading.
- Molded-in handles ensure easy maneuvering.
- Molded-in bumpers minimize damage to walls, furniture and other equipment.

Colors: Navy Blue (186), Slate Blue (401), Coffee Beige (157), Dark Brown (131), Brick Red (402), Green (519), Black (110), Hot Red (158), Granite Grey (191), Granite Green (192), Granite Sand (194).

Tamper-resistant models (for correctional industry) use hinge pins that cannot be removed.

Note: Place food pans on rails. Pans should not be placed on the floor of a Camcart cavity. Please use specified food pan sizes.

Note: If using metal food pans, cool to 120°C before placing onto rails.

Venting plug is covered by US Patent D 553,717 S.

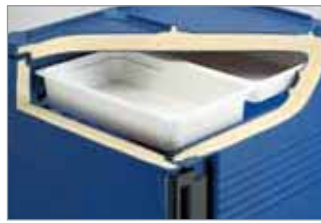

Polyurethane insulation keeps hot food hot and cold food cold.

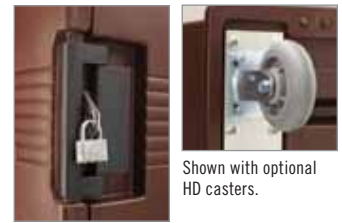

Shown with optional HD casters.

Tamper-Resistant models

are specifically designed for operations where safety and security are a top priority.

These models feature components that withstand severe conditions without safety risks.

Tamper-resistant models (for correctional industry) use hinge pins that cannot be removed.



Marine rail is designed for use during service, not transport.

TOTAL CART HOLDING CAPACITY	UPC600	UPC800	UPC1200	UPC1600
Full Size Food Pans				
6,5 cm deep	8 pans	12 pans	16 pans	24 pans
10 cm deep	6 pans	8 pans	12 pans	16 pans
15 cm deep	4 pans	6 pans	8 pans	12 pans
20 cm deep	2 pans + 2 each 10 cm pans	4 pans	4 pans	8 pans
Camtray®				
3253	12 trays	12 tray	12 trays	48 trays
2632	24 trays	48 trays	—	—
2025	—	—	12 trays	24 trays

See Food Pan and Camtray® Section for ordering information.

*Based on 3,8 cm spacing between trays.

Hot

UPC600	86,8°C	84,3°C	82,5°C	80,8°C	79,3°C
UPC800	87,7°C	85,5°C	84,2°C	82,9°C	81,7°C
UPC1200	85,6°C	82,1°C	80,1°C	78,3°C	77,2°C
UPC1600	87,1°C	85,9°C	85,1°C	84,3°C	83,7°C

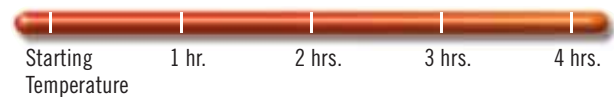

Cold

UPC600	0,6°C	1,1°C	1,4°C	1,8°C	2,1°C
UPC800	0,3°C	0,8°C	0,9°C	1,2°C	1,4°C
UPC1200	0,5°C	0,9°C	1,1°C	1,3°C	1,4°C
UPC1600	0,6°C	1,0°C	1,2°C	1,5°C	1,5°C





UPC600

CODE	UPC600
DESCRIPTION	Base Model
EXTERIOR DIM. W x D x H	52 x 69 x 114,5 cm
COMPARTMENT DIMENSIONS	34 x 54 x 35,5 cm
CASE KG (CUBE M³)	32,48 (0,452)

Case Pack: 1 Casters: 12,7 cm, 2 fixed, 2 swivel, 1 with brake.



UPC800

CODE	UPC800	UPC800TR
DESCRIPTION	Base Model	Tamper Resistant
EXTERIOR DIM. W x D x H	52 x 69 x 137 cm	52 x 69 x 137 cm
COMPARTMENT DIMENSIONS	33 x 54,5 x 48,5 cm	33 x 54,5 x 48,5 cm
CASE KG (CUBE M³)	39,01 (0,546)	39,01 (0,546)

Case Pack: 1 Casters: 15,2 cm, 2 fixed, 2 swivel, 1 with brake.



UPC1200

CODE	UPC1200
DESCRIPTION	Base Model
EXTERIOR DIM. W x D x H	72,5 x 82 x 116 cm
COMPARTMENT DIMENSIONS	54 x 66,5 x 34,5 cm
CASE KG (CUBE M³)	49,29 (0,729)

Case Pack: 1 Casters: 15,2 cm, 2 fixed, 2 swivel, 1 with brake.



UPC1600

CODE	UPC1600	UPC1600HD	*UPC1600TR
DESCRIPTION	Base Model	Base Model with HD Casters	Tamper Resistant
EXTERIOR DIM. W x D x H	71,5 x 82 x 135 cm	73 x 84,7 x 138,4 cm	71,5 x 82 x 135 cm
COMPARTMENT DIMENSIONS	53,5 x 66,5 x 53,5 cm	53,5 x 66,5 x 53,5 cm	53,5 x 66,5 x 53,5 cm
CASE KG (CUBE M³)	63 (0,83)	62,37 (1,06)	63,5 (0,83)

Case Pack: 1 Casters: 15,2 cm, 2 fixed, 2 swivel, 1 with brake.

HD: Heavy-duty, hi-modulus 15,24 x 5,08 cm. 2 fixed, 2 swivel with brake casters.

*Tamper resistant models (TR) have lock-in hinge pins and latches and wheels are attached with tamper resistant screws.



Optional Accessories

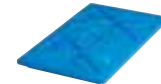
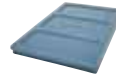
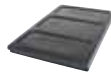
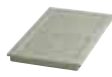

CODE	300DIV	400DIV	1200DIV	1600DIV	CP1220	1210PW
DESCRIPTION	ThermoBarrier®	ThermoBarrier	ThermoBarrier	ThermoBarrier	Camchiller®	Camwarmer®
EXTERIOR DIMENSIONS	L x W x H 53 x 33 x 2,5 cm	L x W x H 54 x 33 x 2,5 cm	L x W x H 53 x 33,5 x 3,5 cm	L x W x H 53 x 33,5 x 3,8 cm	L x W x H 53 x 33 x 3,8 cm	L x W x H 34 x 27,5 x 4 cm
FITS	UPC600	UPC800, UPC800TR	UPC1200	UPC1600	UPC600, UPC800, UPC800TR, UPC1200, UPC1600, UPC1600TR	UPC600, UPC800, UPC800TR
COLOR	Coffee Beige (157)	Grey (180)	Dark Brown (131)	Slate Blue (401)	Cold Blue (159)	Granite Grey (191)
CASE KG (CUBE M³)	1,59 (0,009)	1,63 (0,010)	3,5 (0,02)	2,8 (0,015)	3,70 (0,009)	1,63 (0,005)

Case Pack: 1 1200DIV / 1600DIV Case Pack: 2



Ultra Pan Carrier® and Ultra Camcart® H-Series

- Designed for both electric hot holding and non-electric transport.
- Gentle, 65,6° to 73,9°C non-radiant heat will not cook food and maintains food moisture.
- Holds a wide variety of foods such as pasta, bone-in fried chicken, and double-crustured pies.
- One hour preheat time from room temperature and three minute recovery.
- Energy consumption is substantially less than comparable metal cabinets.
- Will not rust or dent like metal cabinets, is more economical, and is easy to maneuver.
- All UPCH models have been tested to maintain at safe, hot food temperatures, for up to 4 hours when unplugged.
- Models with only the top heated door offer unique versatility with an electric hot holding cabinet on top and passive hot or cold food holding on the bottom.
- Heated door kits also sold separately to retrofit UPC400, UPC800 and UPC1600.

Colors: Granite Gray (191), Black (110), Granite Green (192), Slate Blue (401), Dark Brown (131), Black (110).

Casters: 12,7 cm 2 fixed, 2 swivel, 1 with brake.



Power On and Heat On Indicators

Communicate the Power and Heating status of the UPCH1600 unit. Know instantly when the compartment has reached target temperature.



Vents

Consistent heating throughout the compartment is generated by vents that constantly circulate heat from front to back.



Tough Exterior

All UPCH units are made of tough, polyethylene with polyurethane foam insulation to keep heat in while keeping the exterior cool to the touch. Will not crack, dent, chip, rust or break.



Insulation

CFC-free, foamed-in place polyurethane foam insulation will hold temperature above 164°C for up to 4 hours when used unplugged.

Ultra Pan Carrier® and Ultra Camcart® H-Series

Marine rail is designed for use during service, not transport.



UPCH4002



UPCH8002



UPCH16002

MODEL	UPCH4002	UPCH8002	UPCH16002
Electrical Specifications			
Required Voltage	200 - 230 VAC	200 - 230 VAC	200 - 230 VAC
Maximum Amp.	1,2a	1,2a	2,3a
Watts	265w	265w	506w
Hertz	50/60	50/60	50/60
Plug Type	Euro plug, CEE7	Euro plug, CEE7	CEE7/7 to C15RA
Power Cord Length	2,7 m	2,7 m	2,7 m

Hot Holding When Unplugged

UPCH4002	87,8°C	82,8°C	81,7°C	80°C	78,9°C
UPCH8002	87,8°C	83,9°C	82,8°C	81,1°C	80°C
UPCH16002	87,8°C	82,8°C	81,7°C	80°C	78,9°C



HOT HOLDING

65° — 74°C

WARM UP TIME

(from ambient to temperature)

1 hour

RECOVERY TIME*

(time to recover to temperature after door is held open for 30 seconds)

3 minutes

TRANSPORT TIME*

(after reaching temperature, amount of time unit can be held passively/unplugged until contents reach 65°C.)

4 hours+

*Based on test with 6 each, 15,24 cm deep H-pans with GripLids® filled with approx 14,2 L of 87,7°C water. (Temperatures are of the water not the air in the cart).

Capacity Guide

UPCH4002
UPCH8002 (x2)
UPCH16002 (x4)

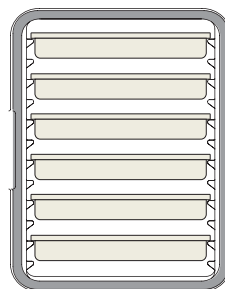

6 x 6,5 cm

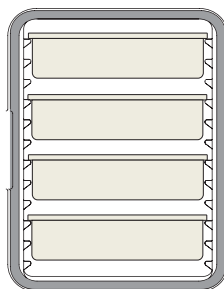

4 x 10 cm

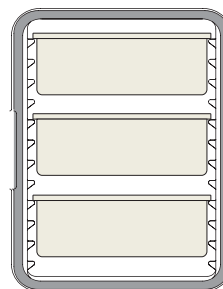

3 x 15 cm

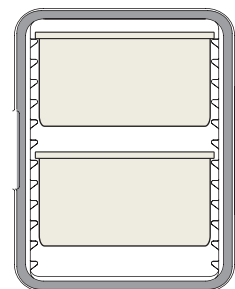

2 x 20 cm

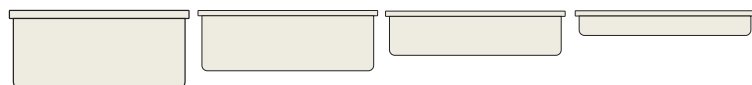

Food Pan Portion Guide

GN 1/3 Food Pan

Depth:	20 cm	15 cm	10 cm	6,5 cm
Serving Portions Per Pan (1 cup):	80	60	40	30

Ultra Pan Carrier® and Ultra Camcarts® H-Series

- Enables HACCP compliance by maintaining safe, hot food temperatures.
- UPCH400(2) models stack for storage or transporting on a Camdolly® with securing strap.

Colors: Granite Grey (191), Granite Green (192), Slate Blue (401), Black (110), Dark Brown (131).

CD400 Colors: Coffee Beige (157), Dark Brown (131), Black (110), Slate Blue (401), Grey (180).

Casters: 12,7 cm 2 fixed, 2 swivel, 1 with brake.

Note: If using metal food pans, cool to 120°C before placing onto rails.

Note: Place food pans on rails. Pans should not be placed on the floor of a Camcart cavity. Please use specified food pan sizes.

Vent Cap Patent Pending.



CODE	DESCRIPTION	EXTERIOR DIMENSIONS W x D x H	COMPARTMENT DIMENSIONS W x D x H	CASE KG. (CUBE M ³)
1-Compartment Hot Holding Ultra Pan Carriers				
UPCH400	Heated Ultra Pan Carrier, 110V	46 x 67 x 63 cm	33,5 x 53,3 x 48,6 cm	20,45 (0,225)
UPCHW400	Heated Ultra Pan Carrier w/Casters, 110V	46 x 67 x 79,4 cm	33,5 x 53,3 x 48,6 cm	24,55 (0,283)
UPCHD400*	Heated UPCH400 Replacement/UPC400 Retrofit Door, 110V	46 x 9 x 53,3 cm	–	5,91 (0,026)
2-Compartment Hot Holding Ultra Camcarts				
UPCH800	Heated Ultra Camcart, 110V	52 x 69 x 137,2 cm	33 x 54,5 x 48,5 cm	43,36 (0,563)
UPCHT800	Ultra Camcart with Heated Top Door Only, 110V	52 x 69 x 137,2 cm	33 x 54,5 x 48,5 cm	43,64 (0,563)
UPCHTD800*	Heated UPCH800 Replacement/UPC800 Retrofit Top Door, 110V	46 x 9 x 53,3 cm	–	5,91 (0,026)
UPCHBD800*	Heated UPCH800 Replacement/UPC800 Retrofit Bottom Door, 110V	46 x 9 x 53,3 cm	–	5,91 (0,026)
UPCH1600	Heated Ultra Camcart, 110V	73 x 84,7 x 137,5 cm	53,5 x 66,5 x 53,5 cm	67,13 (0,942)
UPCH1600HD	Heated Ultra Camcart with Heavy-Duty Casters, 110V	73 x 84,7 x 138,4 cm	53,5 x 66,5 x 53,5 cm	71,6 (1,05)
UPCHT1600	Ultra Camcart with Heated Top Door Only, 110V	73 x 84,7 x 137,5 cm	53,5 x 66,5 x 53,5 cm	60,78 (0,942)
UPCHT1600HD	Ultra Camcart with Heavy-Duty Casters and Heated Top Door Only, 110V	73 x 84,7 x 138,4 cm	53,5 x 66,5 x 53,5 cm	65,3 (1,05)
UPCHTD1600*	Heated UPCH1600 Replacement/UPC1600 Retrofit Top Door, 110V	66,8 x 10,8 x 53,3 cm	–	10,8 (0,047)
UPCHBD1600*	Heated UPCH1600 Replacement/UPC1600 Retrofit Top Door, 110V	66,8 x 10,8 x 53,3 cm	–	10,8 (0,047)
1-Compartment Hot Holding Ultra Pan Carriers				
UPCH4002	Heated Ultra Pan Carrier, 220V	46 x 67 x 63 cm	33,5 x 53,3 x 48,6 cm	20,45 (0,225)
UPCHW4002	Heated Ultra Pan Carrier w/Casters, 220V	46 x 67 x 79,4 cm	33,5 x 53,3 x 48,6 cm	24,55 (0,283)
UPCHD4002*	Heated UPCH400 Replacement/UPC400 Retrofit Door, 220V	46 x 9 x 53,3 cm	–	6,26 (0,026)
2-Compartment Hot Holding Ultra Camcarts				
UPCH8002	Heated Ultra Camcart, 220V	52 x 69 x 137,2 cm	33 x 54,5 x 48,5 cm	43,36 (0,563)
UPCHT8002	Ultra Camcart with Heated Top Door Only, 220V	52 x 69 x 137,2 cm	33 x 54,5 x 48,5 cm	43,64 (0,563)
UPCHTD8002*	Heated UPCH800 Replacement/UPC800 Retrofit Top Door, 220V	46 x 9 x 53,3 cm	–	5,91 (0,026)
UPCHBD8020*	Heated UPCH800 Replacement/UPC800 Retrofit Bottom Door, 220V	46 x 9 x 53,3 cm	–	5,91 (0,026)
UPCH16002	Heated Ultra Camcart, 220V	73 x 84,7 x 137,5 cm	53,5 x 66,5 x 53,5 cm	67,13 (0,942)
UPCH16002HD	Heated Ultra Camcart with Heavy-Duty Casters, 220V	73 x 84,7 x 138,4 cm	53,5 x 66,5 x 53,5 cm	71,6 (1,05)
UPCHT16002	Ultra Camcart with Heated Top Door Only, 220V	73 x 84,7 x 137,5 cm	53,5 x 66,5 x 53,5 cm	60,78 (0,942)
UPCHT16002HD	Ultra Camcart with Heavy-Duty Casters and Heated Top Door Only, 220V	73 x 84,7 x 138,4 cm	53,5 x 66,5 x 53,5 cm	65,3 (1,05)
UPCHTD16002*	Heated UPCH1600 Replacement/UPC1600 Retrofit Top Door, 220V	66,8 x 10,8 x 53,3 cm	–	10,8 (0,047)
UPCHBD16002*	Heated UPCH1600 Replacement/UPC1600 Retrofit Top Door, 220V	66,8 x 10,8 x 53,3 cm	–	10,8 (0,047)
Accessories				
CD400	Camdolly®	53 x 70 x 23 cm	–	7,3 (0,09)
400STP	Strap	5 m long	–	0,5 (–)

UPCH Case Pack: 1 **CD400 Case Pack:** 1 **Casters:** 12,7 cm – 2 fixed, 2 swivel, 1 with brake. **HD:** Heavy-duty, hi-modulus 15,24 x 5,08 cm 2 fixed, 2 swivel with brake casters.

* NOTE: UPCH800(2), UPCH1600(2) top and UPCH1600(2) bottom replacement/retrofit doors are not interchangeable.

Transporter Capacity Guide

Loading Examples for Cambro® Insulated Transporters

TOP LOADERS

UPC140-UPC180
UPCS140-UPCS180
UPCSS160
125MPC

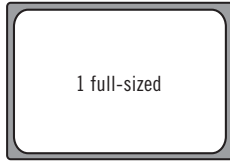

1 full-sized

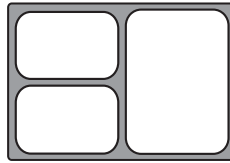

For a 3-course meal:
2 x GN 1/4
1 x GN 1/2
1 DIV12 divider bar
(approx. 14 meals)

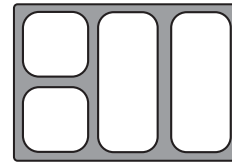

For a 4-course meal:
2 x GN 1/6
2 x GN 1/3
2 DIV12 divider bars
(approx. 14 meals)

TOP LOADERS

100 series
100MPC
UPC100
UPC101

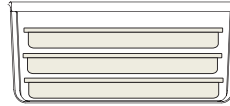

3 x 6,5 cm

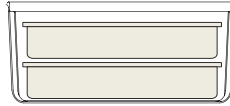

2 x 10 cm



1 x 15 cm
or 1 x 20 cm

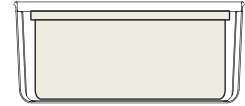

100MPCHL
or 1 x 20 cm

FRONT LOADERS

300MPC
UPC600 (x2)
UPC1200 (x4)

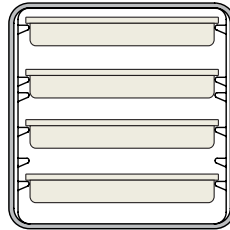
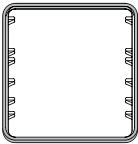

4 x 6,5 cm

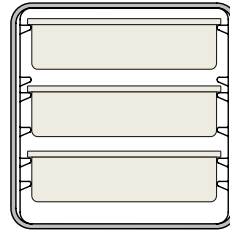

3 x 10 cm

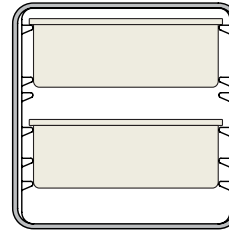

2 x 15 cm

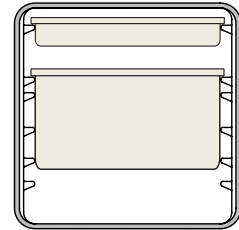

1 x 20 cm
and 1 x 6,5 cm

300MPC Rail Configuration

FRONT LOADERS

UPC400
UPCS400
UPCH4002
UPC800 (x2)
UPCH8002 (x2)
UPC1600 (x4)
UPCH1600 (x4)
CMB1826L (x2)
CMB1826 (x4)

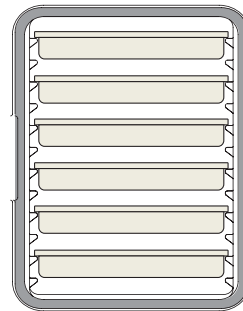

6 x 6,5 cm

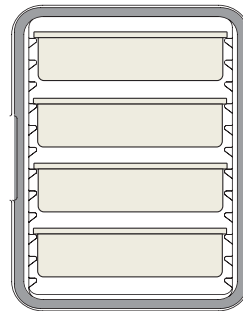

4 x 10 cm

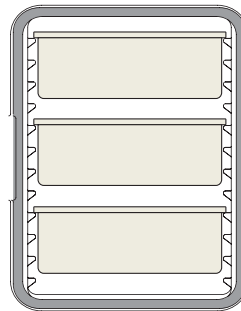

3 x 15 cm

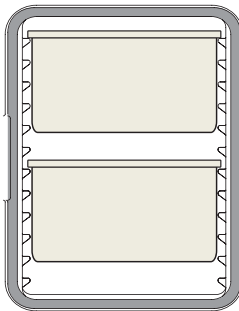

2 x 20 cm

CAMCARRIERS® AND CAMCARTS® FOR SHEET PANS

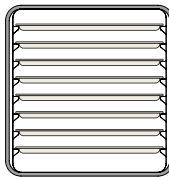

1318MTC
8 x 1/2 size
sheet pans

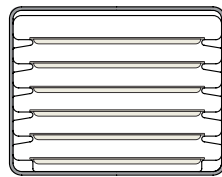

1826MTC
6 x full-size
sheet pans

1826DTC (x4)
CMB1826L (x2)
CMB1826 (x4)

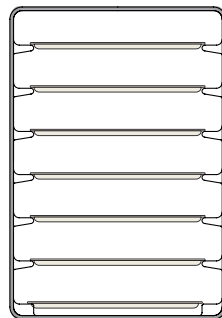

1826LTC3
7 x full-size
sheet pans

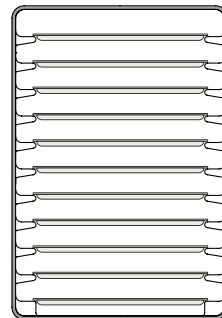

Camtherm Low
11 x full-size
sheet pans
Camtherm Tall (x2)

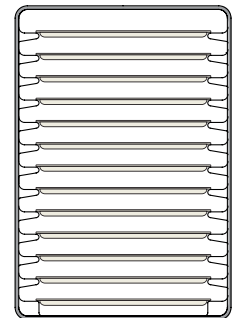

1826LTC
13 x full-size
sheet pans

SUMMARY OF GN CONTAINER SIZES

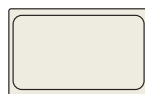

1/2

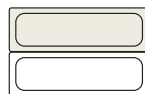

1/2 long



1/2



1/3



1/4

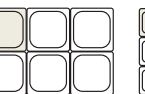

1/6

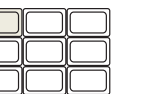

1/8



20 cm

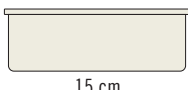

15 cm

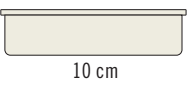

10 cm

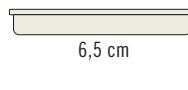

6,5 cm

Depth in Centimeters

Combo Carts™

- Use to hold full-size sheet pans or gastronorm pans of hot or cold food.
- Easy-to-adjust aluminum rails.
- Tough, rotationally molded polyethylene with thick foam insulation.
- Airtight removable gasket provides a secure seal.
- Doors swing open to the side of the cart for easy loading and unloading.

- Molded-in, full-length handle on the back for easy maneuvering.
- Easy to clean.

Colors: Grey (180), Dark Brown (131).
12,7 cm Casters: 2 swivel with brakes. 25,4 cm Wheels.
 * Complete with tamper-resistant hardware for maximum security applications.
 Venting plug is covered by US Patent D 553,717 S.



CMB1826

CODE	EXTERIOR DIMENSIONS	PER CAVITY INSIDE
	W x D x H	DIMENSIONS
	W x D x H	W x D x H
CMB1826	64 x 86 x 150,5 cm	56 x 67,5 x 57 cm
CMB1826L	64,5 x 82,8 x 83 cm	56 x 67,5 x 57 cm

CODE	DESCRIPTION	CASE KG (CUBE M³)
CMB1826	Combo Cart, Tall	111,13 (0,978)
CMB1826L	½ size Combo Cart, Low	65,32 (0,561)
CMB1826SP*	Combo Cart with Security Hardware	111,13 (0,978)
CMB1826LSP*	½ size Combo Cart with Security Hardware	65,32 (0,561)

Case Pack: 1

Insulated Bakery Container – 60 X 40 cm

- Designed for the baking industry in Europe.
- Ideal for transporting products at safe cold temperatures to satellite locations.
- Perfect for baked items with cream fillings or frozen dough.
- Made with a durable polyethylene outer shell and thick polyurethane foam insulation.
- Holds sheet pans:
 - 60 x 40 cm
 - 58 x 40 cm
 - 58 x 20 cm
 - 58 x 10 cm

CP6040 color: Cold Blue (159).
Wire rack color: Silver (000).
Fiberglass Tray colors: Speckled Smoke (A20), Speckled Mocha (A21), Sahara (A22), Light Grey (A27), Pearl White (A33), Terrazzo (A86).
Note: Place sheet pans on rails. Pans should not be placed on the floor of a Container cavity. Please use specified sheet pan sizes.
 Vent Cap Patent Pending.



Camdolly® CD300 makes it easy to transport BK60406 or BK60407.



CODE	BK60406*	BK60407*
DESCRIPTION	Container with 6 rails	Container with 7 rails
EXT. DIM.	76,5 x 57 x 82 cm	76,5 x 57 x 82 cm
INT. DIM.	42 x 63,5 x 67,5 cm	42 x 63,5 x 67,5 cm
CASE KG (CUBE M³)	23 (0,37)	23 (0,37)

Case Pack: 1 Color: Navy Blue (186) * Includes 2 wireracks and 1 chiller.

Accessories

CODE	CD300	CP6040	WR60406	WR60407	GL4060**
DESCRIPTION	Camdolly	Camchiller	Wiereracks w/6 rails	Wiereracks w/7 rails	Market display tray
EXT. DIM.	49 x 65 x 26,5 cm	60 x 40 x 4 cm	66 x 40,5 x 5,8 cm	66 x 40,5 x 5,8 cm	60 x 40 cm
INT. DIM.	43 x 59 cm	—	—	—	—
CASE PACK	1	1	1	1	12
CASE KG (CUBE M³)	8 (0,09)	7,2 (0,013)	2 (0,016)	2,3 (0,016)	2,7 (0,02)

** Not sold in USA, Canada, Mexico, Central America and Caribbean. Vent Cap Patent Pending.

Camtherm® Electric Food Holding Cabinets

Camtherm Food Holding Cabinets hold and transport hot or cold food within the kitchen, on the truck, or at the point of delivery or service. Expand your kitchen capacity, maximize productivity, and hold food

safely for hours. Enjoy the confidence of knowing moist food will stay moist and crisp food will stay crisp.

Discover how one cabinet can do the work of two : with the flip of a switch, go from hot to cold or cold

to hot to increase your storage capabilities and menu flexibility.

Each cabinet combines extreme durability and excellent insulated holding performance with simple, energy-efficient thermoelectric

heating and cooling with :

- **NO COMPRESSOR**
- **NO HEATING COIL**
- **NO HUMIDIFIER**



Low Units

Features & benefits available in both LOW and TALL profile Camtherm carts.

Top marine rail on all units holds 2 full-size food pans, one sheet pan or one cutting board (CB1220).

Solar powered, digital display thermometer monitors internal cabinet temperature.

Self-ventilating cap on each cabinet door automatically releases steam and equalizes pressure, maintaining food quality.

Menu clip holds routing directions or list of cabinet contents.

Non-marking, high modulus, rubber casters are strong and extremely durable providing smooth transport of full cabinets from kitchen to serving location.



Ergonomic molded-in handles are at a safe height on both low and tall profile units for easy transporting, even when fully loaded.

Heavy-duty, 14 gauge electrical cord is 274 cm long. Wrapping hook is located on back of each cabinet for safe cord storage.

Wide, nylon door latches and magnetic door gaskets lock doors securely and create a tight seal to retain safe hot cold food temperatures.

See caster information on following page.

Cabinet exterior stays cool during operation.

Doors swing open 270° for easy loading.

Aluminum louvers gently and evenly direct hot or cold air around the entire cabinet and contents, eliminating hot or cold spots and maintaining food quality.

Knuckle door hinges are built to withstand the rigors of numerous door openings. Doors lift up and off the hinges easily for cleaning.

Easy-to-use control panel is located on back of each unit. Includes on/off switch, hot/cold switch for hot/cold units only and a temperature control dial for hot only. Cold performing units are factory set to chill cabinet down to 2,8°C.

Molded-in bumpers protect walls and furniture and will never dent, chip or rust.



Tough, one-piece, seamless double-wall polyethylene exterior is easy to clean and won't dent, crack, rust, chip or break.

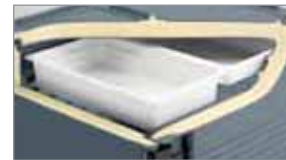

Tall Units

Polyurethane insulation keeps hot food hot and cold food cold during transport when unit is unplugged.

Anodized aluminum uprights and removable, adjustable chrome plated steel slide rails hold full-size food pans or sheet pans.

Energy efficient heating and/or cooling unit located on back of each cabinet. Low volt, low amp, low watt system maintains consistent hot or cold temperature and balanced humidity throughout the single cavity cabinet.

Color: Granite Grey (191), Granite Green (192), Granite Sand (194).

Cutting Board Color: White (148).

Assembly is covered by U.S. Patent D 442,756 S & D 6,344,630. Venting plug is covered by US Patent D 553,717 S.

HOLDING CAPACITY LOW PROFILE

Includes 6 rail sets



Sheet Pan 11 Each 46 x 66 cm
Requires five additional rail sets.

Full-Size GN 1/2 Food Pan - 32,5 x 53 cm

- 12 GN 1/2 6,5 cm Deep
- 8 GN 1/2 10 cm Deep
- 6 GN 1/2 15 cm Deep
- 4 GN 1/2 20 cm Deep

HOLDING CAPACITY TALL PROFILE

Includes 12 rail sets



Sheet Pan 22 Each 46 x 66 cm
Requires ten additional rail sets.

Full-Size GN 1/2 Food Pan - 32,5 x 53 cm

- 24 GN 1/2 6,5 cm Deep
- 16 GN 1/2 10 cm Deep
- 12 GN 1/2 15 cm Deep
- 8 GN 1/2 20 cm Deep

Camtherm® Electric Food Holding Cabinets

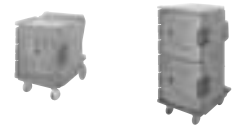

50% more energy efficient than a leading metal cabinet

Model	Total Energy Consumption Over 8 Hours
Camtherm	2,06 kilowatt hours
Metal Cabinet	3,95 kilowatt hours

ELECTRICAL SPECS

	LOW PROFILE	TALL PROFILE
Volts	110V	110V
Plug Type	Nema 5-15P	Nema 5-15P
Maximum amp draw	9,1 A	13,7 A
Amps run on	8,5 A	13,2 A
Watts	1100	1800
Hertz	50/60	50/60
Power input of heating unit	120 VAC	125 VAC

Product Specs CAD Drawings, Cut Sheets and User Manual
Available at www.cambro.com.

	CODE	THERMOMETER	CASTERS	UNIT WEIGHT KG	CASE KG (VOLUME M³)
LOW PROFILE	EXTERIOR dimensions: W 78 x D 107 x H 108 cm				
	Hot Only				
	CMBH1826LC	Celsius	2 front 15,2 cm swivel w/brake, 2 rear 25,4 cm rigid	75 Kg	80,7 (0,93)
TALL PROFILE	EXTERIOR dimensions: W 78 x D 100 x H 165 cm				
	Hot / Cold				
	CMBHC1826LC	Celsius	2 front 15,2 cm swivel w/brake, 2 rear 25,4 cm rigid	101 Kg	107,5 (0,93)

Correctional security package available, please contact Cambro for information

	CODE	THERMOMETER	CASTERS	UNIT WEIGHT KG	CASE KG (VOLUME M³)
LOW PROFILE	EXTERIOR dimensions: W 78 x D 107 x H 108 cm				
	Hot Only				
	CMBH1826LC	Celsius	2 front 15,2 cm swivel w/brake, 2 rear 25,4 cm rigid	75 Kg	80,7 (0,93)
TALL PROFILE	EXTERIOR dimensions: W 78 x D 100 x H 165 cm				
	Hot / Cold				
	CMBHC1826LC	Celsius	2 front 15,2 cm swivel w/brake, 2 rear 25,4 cm rigid	101 Kg	107,5 (0,93)

Correctional security package available, please contact Cambro for information

	CODE	DESCRIPTION	DIMENSIONS H x L x W	CASE KG (VOLUME M³)	CASE PACK
ACCESSORIES	CMBR	Set of Slide Rails	51 x 12,2 cm	1 (0,11)	1 set of 2 Rails
	CB1220	Cutting Board	53,5 x 33,5 x 1,3 cm	1,81 (0,009)	1 each

Cutting Board Color: White (148).

Time & Temperature Performance

HOT

WARM UP TIME
From ambient to hot.

RECOVERY TIME
Time to recover to hot temperature after door is held open for 30 seconds.

TRANSPORT TIME
After reaching hot temperature, amount of time unit can be held passively / unplugged until temperature reaches (65°C).

	(65°C)	(74°C)	(65°C)	(74°C)	(65°C)	(74°C)
LOW						
Hot	33 minutes	45 minutes	2 minutes	4 minutes	5 hours	8 hours
Hot/Cold	33 minutes	45 minutes	2 minutes	4 minutes	5 hours	8 hours
TALL						
Hot Unit	30 minutes	60 minutes	1 minute	3 minutes	4 hours	8 hours
Hot/Cold Unit	45 minutes	75 minutes	1 minute	3 minutes	6 hours	8 hours

All results based on tests with 6 full-size 15 cm deep H-Pans™ filled with 87,7°C hot water, covered and placed inside upper cabinet only.

Cold

WARM UP TIME
From ambient to cold.

RECOVERY TIME
Time to recover to hot temperature after door is held open for 30 seconds.

TRANSPORT TIME
After reaching cold temperature, amount of time unit can be held passively / unplugged until temperature reaches (65°C).

	(2,8°C)	(2,8°C)	(2,8°C)
LOW			
Hot/Cold Unit	50 minutes	4 minutes	2 Hours
TALL			
Hot/Cold Unit	75 minutes	4 minutes	1 Hour

All results based on tests with 6 full-size GN ¼ 15 cm deep Polycarbonate Food Pans filled with 1,1°C cold water, covered and placed inside upper cabinet only.
Vent Cap Patent Pending.

Camcarts® – 46 X 66 cm Trays, Sheet Pans & Food Boxes



- Use to hold hot or cold bulk food stored on trays, sheet pans or in food boxes.
- Durable polyethylene and thick foam insulation retain safe food temperatures.
- Sturdy plastic, rust-proof latches are secured into molded-in mounting plates.
- Molded-in handle on the back for easy maneuvering.



Colors: Slate Blue (401), Coffee Beige (157), Dark Brown (131), Grey (180).

15,2 cm Casters: 2 fixed, 2 swivel, 1 with brake.

Note: Cool metal sheet pans to 121°C before placing onto tray supports.

Venting plug is covered by US Patent D 553,717 S.



1826DBC only.

1826DTC Double Cavity Cart for Trays and Sheet Pans

Capacity: 24 tray support rails on 4,92 cm centers (12 per cavity). Holds up to 24 each 46 x 66 cm trays or sheet/bun pans.

1826DBC Double Cavity Cart for Food Storage Boxes

Capacity: 26 support rails on 4,92 cm centers (13 per cavity). Holds 46 x 66 cm Food Storage Boxes.

Camcart with Security Package

Specially designed for high security applications, with tamper-resistant hardware: metal hinges with non-removeable pins, metal latches with welded bails, lockable hasp and no chassis plate.



Caster Impact Plates
Impact plates add metal reinforcement to hold casters in place even when dropped.

CODE	DESCRIPTION	EXTERIOR DIMENSIONS W x D* x H	INTERIOR DIMENSIONS W x D* x H	CASE KG (CUBE M ³)
1826DTC	For trays & sheet pans	55 x 84,5 x 162 cm	46,4 x 67,3 x 64,6 cm	61,23 (0,791)
1826DBC	For food storage boxes	55 x 84,5 x 162 cm	46,4 x 67,3 x 64,9 cm	62 (0,8)
Camcarts with Security Packages				
1826DTCSP	For trays & sheet pans	55 x 84,5 x 162 cm	46,4 x 67,3 x 64,6 cm	61,23 (0,791)
1826DBCSP	For food storage boxes	55 x 84,5 x 162 cm	46,4 x 67,3 x 64,9 cm	65,23 (0,8)

Case Pack: 1 *Depth measurement includes handle.



Camcarriers® – 32,5 X 53 cm Trays, Sheet Pans & Food Boxes Camcarts® – 46 X 66 cm Trays, Sheet Pans & Food Boxes



1318MTC

Camcarrier for Full-size Food Pans, Trays and Half-size Sheet Pans

- Holds up to 8 each 33 x 46 cm sheet pans or 3 each full-size 10 cm deep food pans.
- Molded-in handles.
- Stackable for storage and transport.
- Fits CD300 Camdolly.



1826LBC

Camcart for Food Storage Boxes

- Holds 46 x 66 cm Food Storage Boxes.
- Capacity: 13 supports on 4,45 cm centers.
- Includes removable cutting board on top.



1826MTC

Camcarrier for Trays and Sheet Pans

- Holds up to 6 each 46 x 66 cm sheet pans.
- Six tray supports on 5,4 cm centers.
- Molded-in handles.
- Fits CD1826MTC Camdolly.



1826LTC3

Camcart for Trays and Sheet Pans

- Holds up to 7 each 46 x 66 cm trays or sheet pans.
- Seven tray supports on 9,5 cm centers for 7,62 cm clearance between trays.
- Includes removable cutting board on top.



1826LTCSP

Camcart with Security Package

- Specially designed for high security applications.
- Features tamper-resistant hardware to protect both cart and contents.
- Includes removable cutting board on top.



1826LTC

Camcart for Trays and Sheet Pans

- Holds up to 13 each 46 x 66 cm trays or sheet pans.
- Thirteen tray supports on 4,45 cm centers.
- Includes removable cutting board on top.

Colors: Slate Blue (401), Grey (180), Coffee Beige (157), Dark Brown (131), Navy Blue (186). 1826MTC is available in Black (110).

1318MTC Colors: Navy Blue (186), Slate Blue (401), Coffee Beige (157), Dark Brown (131), Black (110). 1318MTC not available in Grey (180).

Strap Color: Beige (000).

Camdolly® Colors: Slate Blue (401), Coffee Beige (157), Dark Brown (131), Grey (180), Black (110).

CD1826MTC: 12,7 cm Casters: 2 fixed, 2 swivel, 1 with brake.

CD1826MTCHB: 12,7 cm Casters: 2 swivel, 1 with brake and 2 25,4 cm Easy Wheels.

* With handle.

** Cart comes complete with tamper-resistant hardware for maximum security applications.

15,2 cm Casters: 2 fixed, 2 swivel, 1 with brake.

Note: Cool metal sheet pans to 121°C before placing onto tray supports.



CODE	DESCRIPTION	EXTERIOR DIMENSIONS W x D* x H	INTERIOR DIMENSIONS W x D* x H	CASE KG (CUBE M³)
1318MTC	For trays, sheet pans & GN Food Pans	42,5 x 62 x 57 cm	33,3 x 53,3 x 36 cm	14,4 (0,16)
1826MTC	For trays & sheet pans	55 x 74,5 x 57 cm	46,7 x 66,4 x 33,3 cm	18,75 (0,246)
Camdolly				
CD300	Camdolly for 1318MTC	53 x 70 x 23 cm	46 x 63,5 cm	7,3 (0,09)
CD1826MTC	Camdolly for 1826MTC	61 x 89 x 91 cm	55,9 x 72,4 cm	16 (0,49)
CD1826MTCHB	Camdolly with Easy Wheels for 1826MTC	70 x 89 x 93,5 cm	55,6 x 72,5 cm	22 (0,59)
Camcarts				
1826LTC	For trays & sheet pans	55 x 81,5 x 95,5 cm	46 x 66,4 x 66,7 cm	39 (0,46)
1826LTC3	For trays & sheet pans	55 x 81,5 x 95,5 cm	46 x 66,4 x 66,7 cm	39 (0,46)
1826LBC	For Food Storage Boxes	55 x 81,5 x 95,5 cm	46 x 66,4 x 66,7 cm	39 (0,46)
Camcarts with Security Package**				
1826LTCSP	For trays & sheet pans	55 x 81,5 x 95,5 cm	46 x 66,4 x 66,7 cm	39 (0,46)
1826LBCSP	For Food Storage Boxes	55 x 81,5 x 95,5 cm	46 x 66,4 x 66,7 cm	39 (0,46)
Securing Strap				
1826STP	Securing Strap	—	—	2,18 (0,016)

Case Pack: 1 Venting plug is covered by U.S. Patent D 553,7175 S

Beverage Service Carts



- Ideal for breakfast, coffee or snack service.
- Use top counter to hold Cambro Beverage Servers, Versa Organizer Bins or Display Trays with Covers for food.
- Store drinkware, additional food items or other supplies in open compartment.
- Insulated cabinets hold hot or cold food in full, ½ or ⅓ size food pans or on Cambro Metric Camtrays® (3253).

Colors: Slate Blue (401), Granite Grey (191), Granite Green (192).

See Organizer section for more information on Organizer Bins.

See Camtainer section for more information on Camtainers.

Wire Rack Color: Silver (000).

See Cold Pack section for more information on Cold Packs.

15,2 cm Casters: 2 fixed, 2 swivel, 1 with brake.

For complete specifications, call or write Cambro.



Beverage Service Cart is designed to hold Beverage Containers at point of service only. A dolly or hand truck with safety strap is recommended for moving Beverage Containers over longer distances or uneven surfaces.



MDC24F



MDC24 has recessed top that holds 3 each 3,8 Liters 100LCD Camtainers and stacked Condiment Bins & Wire Rack with 3253 trays.

CODE	EXTERIOR DIMENSIONS L x W x H	CASE PACK	CASE KG (CUBE M ³)
MDC24	113 x 76 x 112 cm	1	60,33 (1,071)
MDC24F	113 x 76 x 112 cm	1	60,33 (1,071)
OPTIONAL ACCESSORIES			
Organizer Bin			
5412CBP	30,5 x 13 x 11 cm	12	3,57 (0,05)
Camtainer®			
100LCD	26,5 x 30 x 44 cm	1	4,5 (0,035)
Wire Rack			
MDC24R	58,4 x 43,2 x 35,5 cm	1	6,8 (0,1015)
Camchiller®			
CP1220	53 x 33 x 3,8 cm	1	11 (0,38)

The use of racks in the MDC24 and MDC24F carts will allow the following configuration of pans or trays, per compartment:

DESCRIPTION	GN (½)	GN (⅓)	GN (¼)
6,5 cm Pans	(4) 12CW	(8) 22CW	(12) 32CW
10 cm Pans	(3) 14CW	(6) 24CW	(9) 34CW
15 cm Pans	(2) 16CW	(4) 26CW	(6) 36CW
20 cm Pans	(1) 18CW**	(2) 28CW**	(3) 38CW**

** with room for 6,5 cm or 10 cm pan above 15 cm pan. 10 each 3253 Metric Camtrays®.

Compartment Dimensions

Shelf Compartment	W 96,5 cm	D 64 cm	H 25,4 cm
Holding Compartments	W 44,5 cm	D 60,3 cm	H 36 cm

Venting plug is covered by US Patent D 553,717 S.

MDC24R Wire Rack

Wire Rack (sold separately) to organize pans and trays in the cart. Rack holds Full, ½ and ⅓ size Food Pans and 3253 trays. When placed in cart's core area, the rack allows room on either side of pan positions for Cambro's CP1220 Camchillers® one on each side.



HEALTHCARE



Why Cambro Healthcare?

For over 60 years Cambro has been focused on developing innovative solutions to the toughest challenges in the foodservice industry. Cambro Healthcare products are designed to perform consistently under the most demanding conditions of healthcare foodservice.

The Components for Successful Meal Service and Patient Satisfaction

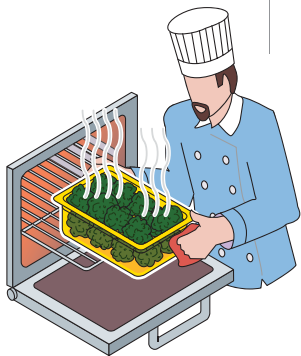
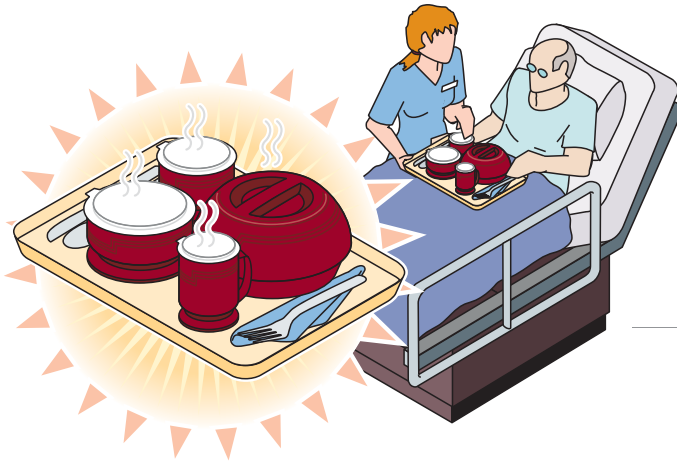

Hot Food

The goal of any meal delivery system is to keep food hot and fresh. Safe food handling and preparation are the first steps.



Hot Plate

Hot food needs a plate heated to proper temperatures. A plate that is not heated diminishes food quality for patients.

Plates should be heated between 65°C and 77°C.

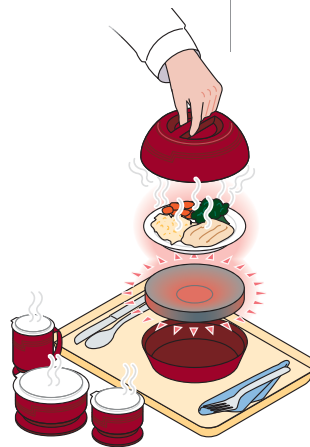

Temperature Maintenance System

NSF-listed, meal delivery ware consisting of mugs, bowls, insulated domes and heated bases/pellets specifically designed for healthcare foodservice are vital to temperature maintenance.

Bases and Pellets should be heated between 132°C and 144°C.



Meal Transportation

From meal delivery carts to individual Tablotherm meal transport systems, these products can extend the heat retention of the meal to the patient's bedside.

Tablotherm Pellet System achieves temperature retention of 64°C for 2 hours.

Meal Delivery Ware

Camtherm® Thermal Pellet System The perfect choice for maximum heat retention.



CODE	MDS09	MDSL09	MDSL9	MDSPLT9	MDSP9
DESCRIPTION	Insulated Dome	Low Profile Insulated Dome	Pellet Underliner	Ceramic Plate	Thermal Pellet
APPROX. CAPACITY	22,86 cm	22,86 cm	24,13 cm	—	22,86 cm
OUTSIDE DIAMETER	25,9 cm	25,9 cm	24,29 cm	22,86 cm	24 cm
HEIGHT	7,3 cm	6,99 cm	4,6 cm	2,54 cm	4,45 cm
FULL-SIZE CAMRACK®	PR59314	PR59314	PR59314	CRP20910	PR59314
CASE PACK	12	12	12	24	12
CASE KG. (CUBE M³)	4,88 (0,04)	4,44 (0,03)	2,38 (0,01)	17,6 (0,02)	13,56 (0,02)

MDSP9 Color: Dark Gray (477). MDSPLT9 Color: Ivory (000).

Heat Keeper Insulated Base System The cost-effective solution for heat retention.



CODE	MDS09	MDSL09	MDSPLT9	HK39B
DESCRIPTION	Insulated Dome	Low Profile Insulated Dome	Ceramic Plate	Insulated Base
APPROX. CAPACITY	22,86 cm	22,86 cm	—	24,13 cm
OUTSIDE DIAMETER	25,9 cm	25,9 cm	22,86 cm	24,29 cm
HEIGHT	7,3 cm	6,99 cm	2,54 cm	4,6 cm
FULL-SIZE CAMRACK®	PR59314	PR59314	CRP20910	PR59314
CASE PACK	12	12	24	12
CASE KG. (CUBE M³)	4,88 (0,04)	4,44 (0,03)	17,6 (0,02)	2,38 (0,01)

MDSPLT9 Color: Ivory (000). HK39B Colors: Black (110), Cranberry (487), Navy Blue (497), Speckled Gray (480).

Low Profile Dome Comparison Perfect for limited tray spacing

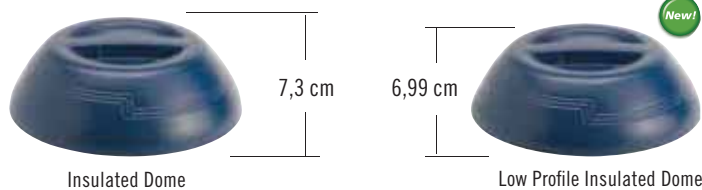

Safely lift hot, thermal pellets or plates with the Cambro Pellet Lifter.

Accessories



CODE	MDSM8	MDSB5	MDSB9	MDSB16	MDSPL
DESCRIPTION	Mug	Sm. Bowl	Lg. Bowl	Entree Bowl	Pellet Lifter
APPROX. CAPACITY	0,24 L	0,15 L	0,27 L	0,47 L	—
OUTSIDE DIAMETER	8,89 cm	8,89 cm	11,11 cm	13,34 cm	8,0 cm
HEIGHT	10,16 cm	6,03 cm	6,03 cm	6,03 cm	7,6 cm
FULL-SIZE CAMRACK®	16C414	16C414	9S318	9S318	—
CASE PACK	48	48	48	48	1
CASE KG. (CUBE M³)	5,22 (0,04)	3,36 (0,03)	4,57 (0,04)	17 (2,29)	0,18 (0,001)

* MDSM8 Diameter 11,43 cm with Handle. MDSPL Color: (000).

The Shoreline
Collection Colors:



110
Black



480
Speckled Gray



487
Cranberry



497
Navy Blue

Reusable CamLids® for Meal Delivery Systems

- Save up to 75% in lid costs each year.
- Reduce your waste-stream significantly each year when you switch from disposables to reusables.*
- Dishwasher safe.
- Contact your Cambro Sales Representative for a Customized Savings Calculator!

*Based on 100 bed facility using 3 disposable lids for 3 meals daily.

Reusable Lids Color:
Speckled White (490), Midnight Blue (453).

Camrack Wash and Store Rack Color:
Kelly Green (452).

Camrack Base Full Size Color:
Soft Grey (151).

Full Rack Cover Color: Grey (180).

CLRWSR36 is covered under U.S. patent D 617,069.

Full Rack Cover not NSF certified.



Camrack® Wash and Store Rack

Specifically designed for safely and securely washing and storing Reusable CamLids. Each Camrack Wash and Store Rack holds 36 Reusable CamLids.



CLRWSR36



Wash and store Racks in Full Size Base Rack.

CODE	DESCRIPTION	DIMENSIONS H x Dia.	CASE KG (CUBE M ³)	CASE PACK
Reusable CamLids				
CLRSMB5	Fits Shoreline 0,24 L mug and 0,15 L bowl	0,72 cm x 9,56 cm	2,35 (0,02)	240
CLRSB9	Fits Shoreline 0,27 L bowl	0,72 cm x 11,81 cm	3,75 (0,04)	240
CLRSB16	Fits Shoreline 0,47 L bowl	0,72 cm x 13,97 cm	4,25 (0,04)	240
Accessories		L x W x H		
CLRWSR36	Camrack Wash and Store Rack to wash 36 Reusable Lids	20,96 x 54,72 x 13,97 cm	1,91 (0,036)	4
BR578	Camrack Full Size Base Rack with 2 extenders	50 x 50 x 18,4 cm	10,22 (0,194)	4
DRC2020	Full Rack Cover	50 x 50 x 2,4 cm	0,91 (0,0098)	1

Reusable CamLids sold in cases only. No broken cartons.

Visit www.cambro.com/savemoney for a Customized Savings Calculator!

Camshelving® Drying and Storage Cart

- Keeps trayline and dishwashing areas organized and efficient.
- Cradles made of stainless steel.
- Shelving posts and traverses feature a steel core with a smooth polypropylene exterior.
- Cradles are removable and fit into a Camrack® base rack for dishwasher service.
- Dome Drying Rack holds 100 each 10" domes and/or pellet underliners.

Color:
Cart - Speckled Grey (480),
Cradle - Stainless Steel (000).



CSDDCPKG480

CODE	DESCRIPTION	DIMENSIONS L x W x H	CASE KG. (CUBE M ³)
CSDDCPKG480*	Dome Drying and Storage Cart	91 x 46 x 191 cm	51,82 (0,29)
CSDC	Dome Drying Cradle	25,4 x 45 x 41 cm	7,73 (0,071)

Case Pack: 1

*Ships in 3 cartons, Carton 1: 2 Post Kits, 10 Traverses and 4 Casters, Carton 2: Set of 5 Drying Cradles, Carton 3: Set of 5 Drying Cradles.

Disposable CamLids® for Shoreline



New!



LID CODE	CLSM8B5	CLS89	CLSB16	CLSSM8B5
DESCRIPTION	Sm. Disp. Lid	Lg. Disp. Lid	Disp. Entree Bowl Lid	Disp. Sip. Lid
FITS	MDSB5, MDSM8	MDSB9	MDSB16	MDSB5, MDSM8
OUTSIDE DIAMETER	8,89 cm	11,11 cm	14,02 cm	1,89 cm
HEIGHT	0,76 cm	0,76 cm	0,76 cm	1,75 cm
CASE PACK	1,500	1,000	1,000	1,000
CASE KG (CUBE M ³)	3,51 (0,07)	3,22 (0,06)	5,9 (0,071)	3,21 (0,06)

CLSM8B5, CLS89 and CLSB16 Color: Translucent (190). CLSSM8B5 Color: White (148).

Cases only. No broken cartons.

Disposable CamLids® for Tumblers and Bowls



New!



Disposable Lids for Newport Tumblers

LID CODE	CLNT5	CLNT8	CLNT10	CLNT12	CLNT20
FITS TUMBLERS	NT5	NT8	NT10	NT12	NT20
TUMBLER CAPACITY	189 mL	228 mL	300 mL	373 mL	650 mL
CASE PACK	1,500	1,000	1,000	1,000	1,500
CASE KG (CUBE M ³)	2,72 (0,03)	2,72 (0,03)	2,72 (0,03)	2,72 (0,03)	2,27 (0,03)

Color: Translucent (190). Cases only. No broken cartons.



Disposable Lids for Laguna® Tumblers

LID CODE	CLLT6	CLLT10	CLLT12
FITS TUMBLER	LT6	LT10	LT12
TUMBLER CAPACITY	177,4 mL	295,7 mL	354,9 mL
CASE PACK	1,500	1,000	1,000
CASE KG (CUBE M ³)	2,72 (0,03)	2,72 (0,03)	2,72 (0,03)

Color: Translucent (190). Cases only. No broken cartons.



Disposable Lids for Colorware Tumblers

LID CODE	CL900P	CL950P
FITS TUMBLERS	900P / 900P2	950P / 950P2
TUMBLER CAPACITY	287 mL	290 mL
CASE PACK	1,000	1,000
CASE KG (CUBE M ³)	2,72 (0,03)	2,72 (0,03)

Color: Translucent (190). Cases only. No broken cartons.

Disposable Lid for Swirl Bowls



LID CODE	CLSRB5
FITS SWIRL BOWLS	SRB5CW / SRB5
SWIRL BOWL CAPACITY	148 mL
CASE PACK	1,000
CASE KG (CUBE M ³)	4,54 (0,06)

Color: Clear (152). Cases only. No broken cartons.

Microban® Antibacterial Camguard® Versa Trays

- High performance polyester tray for ultra-intensive use.
- Built-in Microban® antibacterial protection eliminates bacteria between tray washings and will not wash off or wear away for the life of the tray.
- Reinforced polyester corners provide superior corner and edge protection against impact.
- Stacking lugs allow air circulation for fast drying and perfect stacking.
- Temperature range resistance from -40°C to 140°C.‡
- Dishwasher safe – Wash as often and as frequently as needed.



‡ Not for use in heated carts.

CAMGUARD
ANTIBACTERIAL



High Profile Shape Low Profile Design Shape



Flat Edge Shape



Built-in Antimicrobial Protection from Microban Eliminates Bacteria

Microban 3G-Silver™ is built into every Cambro Camguard Versa Tray to protect against the harmful effects of bacteria. Microban eliminates existing bacteria and prevents the growth of new bacteria. This protection cannot be washed off and does not wear away over time. This built-in defense lasts for the life of the tray.

Unprotected Surface versus Microban 3G-Silver™ Treated Surface 24 Hour Test

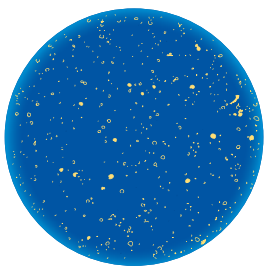

Untreated

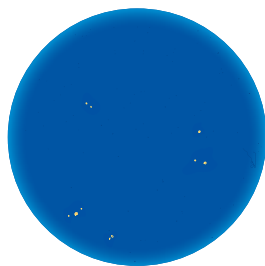

Treated with Microban®

CODE	DIMENSIONS (CM)	CASE KG. (CUBE M ³)
Versa Trays – High Profile Shape		
VT1418AB	35,5 x 45,7	8,8 (0,013)
VT3343AB	33,0 x 43,0	8,7 (0,016)
Versa Century™ Trays – Low Profile Design Shape		
VT3646CAB	35,5 x 45,7	8,8 (0,013)
VT3343CAB	32,9 x 42,9	8,7 (0,016)
Versa Trays – Flat Edge Shape		
GP1070AB*	32,5 x 26,5	5,3 (0,009)
GP1080AB*	37,0 x 26,5	5,5 (0,01)
GP3980AB*	53,0 x 37,0	11,3 (0,02)
GP4002AB*	53,0 x 32,5	10,0 (0,019)

Case Pack: 12

* Designed with reinforced corners for automatic off-stacking onto conveyor belt dishwashers.



Innovative low profile and low corner design increases space utilization of tray surface and customer comfort while eating.



Reinforced polyester corners provide superior corner and edge protection against impact.



Stacking lugs allow free air circulation for fast drying and perfect stacking.

Tray Color:



A83
Granite

Polyester Decorated Versa Trays with Non-Slip Surface

- Reduce waste, save money and provide a stable tray surface for meal delivery.
- Switching from paper tray mats will generate annual savings of over 50%.
- Your Green Initiatives will get rapid results with the elimination of up to 10 tons of trash each year.
- High performance polyester tray for ultra-intensive use.
- Reinforced polyester corners provide superior corner and edge protection against impact.
- Stacking lugs allow air circulation for fast drying and perfect stacking.
- Temperature range resistance from -40°C to 80°C.‡
- Dishwasher safe – Wash as often and as frequently as needed.



Personalization: Contact your Cambro representative for pricing.

‡ Not for use in heated carts.



Flat Edge Shape

CODE	DIA/ SIZE (CM)	CASE PACK	CASE KG. (CUBE M ³)
Versa Trays – Flat Edge Shape			
GP3980NS*	53,0 x 37,0	12	11,3 (0,020)
GP4002NS*	53,0 x 32,5	12	10,0 (0,019)
GP0540NS*	46,0 x 34,4	12	9,2 (0,019)
GP1080NS*	37,0 x 26,5	12	5,5 (0,010)

* Designed with reinforced corners for automatic off-stacking onto conveyor belt dishwashers.



Non-Skid Trays grip firmly providing safer meal delivery service

Patterns and Tray Base Colors:



B22
Sahara on Sahara Tray

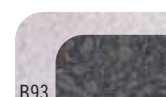

B93
Titan on Granite Tray

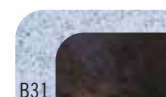

B31
Lava on Speckled Blue Tray

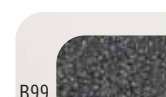

B99
Pebbled Black on Light Grey Tray



B100
Pebbled Black on Terrazzo Tray

Non-Skid Versa Lite Trays

- Non-Skid surface provides a better grip for safer meal delivery.
- Reduce your environmental waste-stream each year when you switch from paper tray mats to Non-Skid Versa Lite Trays.
- Standard performance polyester tray for intensive use.
- Reinforced polyester corners provide superior corner and edge protection against impact.
- Stacking lugs allow air circulation for fast drying and perfect stacking.
- Temperature range resistance from -40°C to 80°C.‡
- Dishwasher safe – Wash up to 3 times per day.



Personalization: Contact your Cambro representative for pricing.
‡ Not for use in heated carts.

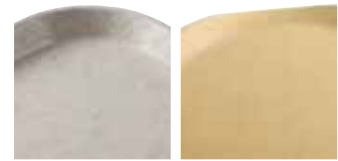

High Profile Shape Low Profile Design Shape



Flat Edge Shape



Versa Lite Century Trays have low edges and ergonomic corners that enhance comfort.



Stacking lugs allow free air circulation for fast drying and perfect stacking.



Reinforced polyester corners provide superior corner and edge protection against impact.

Tray Colors:

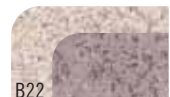

B22 Sahara on Sahara Tray



B14 Titan on Speckled Smoke Tray

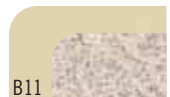

B11 Sahara on Pearl White Tray

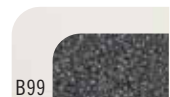

B99 Pebbled Black on Light Grey Tray



Non-Skid Trays grip firmly providing safer meal delivery service

CODE	DIMENSIONS (CM)	CASE KG. (CUBE M ³)
Versa Trays – High Profile Shape		
VL1418NS	35,5 x 45,7	10,0 (0,020)
VL3343NS	33,0 x 43,0	8,7 (0,016)
Versa Century™ Trays – Low Profile Design Shape		
VL3646CNS	35,5 x 45,7	8,8 (0,013)
VL3343CNS	33,0 x 43,0	8,7 (0,016)
Versa Trays – Flat Edge Shape		
GL3980NS*	53,0 x 37,0	11,3 (0,020)
GL4002NS*	53,0 x 32,5	10,0 (0,019)

Case Pack: 12

* Designed with reinforced corners for automatic off-stacking onto conveyor belt dishwashers.

Non-Skid Versa Camtrays®

- Non-Skid Trays reduce waste, save money and provide a stable tray surface for meal delivery.
- Switching from paper tray mats will generate annual savings over 50%.
- Your Green Initiatives will get rapid results with the elimination of up to 9000 Kg of trash each year.
- Non-Skid Camtrays provide a better grip for safer meal delivery.
- Dishwasher safe in low and high temperatures.
- Stacking lugs allow for quick drying.
- Temperature range resistance from -40°C to 80°C.‡

Camtray and Dietary Tray Colors:
Black with Pebbled Black (382), Pearl Gray with Titan (381), Ivory with Sahara (380).

Century Camtray Colors: Pearl Gray with Titan (381), Ivory with Sahara (380).



Personalization: Contact your Cambro representative for pricing.
‡ Not recommended for heated carts.



High Profile Shape

Low Profile Design Shape



Flat Edge Shape



Versa Dietary Tray

CODE	DESCRIPTION	DIMENSIONS	CASE KG (CUBE M³)
1418VC	Non-Skid Versa Camtray	36 x 46 cm	9,43 (0,02)
1520VC	Non-Skid Versa Camtray	38 x 51 cm	11,84 (0,017)
1622VC*	Non-Skid Versa Camtray	41 x 56 cm	14,1 (0,03)
1418VDC	Non-Skid Versa Dietary Tray	36 x 46 cm	9,3 (0,02)
1520VDC	Non-Skid Versa Dietary Tray	38 x 51 cm	12,23 (0,02)
1418VCC	Non-Skid Versa Century Camtray	36 x 46 cm	9,27 (0,01)
1520VCC	Non-Skid Versa Century Camtray	38 x 51 cm	11,96 (0,02)

Case Pack: 12 *1622VC is not available in Black with Pebbled Black (382).



Non-skid trays grip table top items firmly.

Non-Skid Versa Camtrays for Room Service

- Ergonomic handles allow for safe and elegant meal delivery.
- Trays fit within existing meal delivery carts for 38 x 51 cm trays.
- Non-skid surface eliminates the need for tray mats saving time and money.
- Dishwasher safe at high and low temperatures.
- Stacking lugs allow for quick drying.
- Temperature range resistance from -40°C to 80°C.‡

Room Service Tray Colors:
Black with Pebbled Black (382), Pearl Gray with Titan (381), Ivory with Sahara (380).

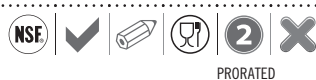

Personalization: Contact your Cambro representative for pricing.
‡ Not recommended for heated carts.



CODE	DESCRIPTION	DIMENSIONS	CASE KG (CUBE M³)
1520VCRST	Room Service Non-Skid Camtray	38 x 51 cm	12,7 (0,3)

Case Pack: 12

Personalization available.
Visit www.cambro.com for details.

Tablotherm Meal Delivery System

The ideal single-serve meal delivery system for in-home service.

- Transport and serve hot and cold food in one complete unit.
- Maintain safe food temperatures for over 2 hours.
- Lightweight design makes transportation easy and convenient.
- Two sizes accommodate a variety of meal options.
- Dishwasher safe up to 120°C.



Tablotherms stack for easy transportation and storage.



Molded-in dimples secure the sealed lids on dishware to prevent spills and enhances temperature retention.

CFC-free foamed-in insulation.

Compact design makes transport easy.



Break-resistant china dishware.

Safely hold Hot and Cold meals in one unit.



Meal set-up is convenient with Tablotherm trays and dishes.



Tablotherms are designed for dining comfort.

Tablotherm Insulated Trays

SPECIFICATIONS

Material	Polypropylene + Foam Insulation
Characteristic	Insulated Tray
Performance	Excellent
Heat Retention	64°C for Approximately 120 Minutes
Dishwasher Safe	Yes
Stackable	Yes
Minimum Food Temperature before Plating	80°C to 90°C‡
Individual Dish Cover	Yes – Prevent Spilling of Soup and Sauces



‡ Not for use in heated carts.

ITPD3253 model with Heated Pellet

85°C 80,9°C 77,4°C 74,2°C 71,1°C 68,1°C 65,4°C

ITPD3253 model without Heated Pellet

85°C 72,8°C 68,3°C 64,8°C 61,8°C 59,1°C 56,6°C

ITP3753 model with Heated Pellet

85°C 80,2°C 76,6°C 73,1°C 70°C 66,9°C 64,1°C

ITP3753 model without Heated Pellet

85°C 69,8°C 64,9°C 61,2°C 58°C 55,3°C 52,8°C



Pellet system allows to retain serving temperature of 64.1°C for 2 hours. Actual test done on ITPD3753 and ITPD3253 with hot water.



ITPD3253 - Gastronorm size



ITPD3753 - Euronorm size



Light gray polypropylene lid with integrated rubber seal. Lids cannot be used in microwave oven.

For a complete guide to maximizing heat retention, contact your Cambro representative.

CODE	DESCRIPTION	DIMENSIONS W x L x H (CM)	CASE KG (CUBE M ³)
Tablotherm – Insulated Tray with Porcelain Dishes, seal covers and pellet			
ITPD3753	Euronorm insulated tray including: 1 ea. two-compartment menu plate - 122 400 050 and 1 ea. cover 122 600 050 and 1 ea. pellet 165PW 3 ea. multiple-use bowl - 122 500 050 and 3 ea. cover 122 700 050.	37,0 x 53,0 x 10,5	5,4 (0,024)
ITPD3253	Gastronorm insulated tray including: 1 ea. two-compartment menu plate - 122 400 050 and 1 ea. cover 122 600 050 and 1 ea. pellet 165PW 2 ea. multiple-use bowl - 122 500 050 and 2 ea. cover 122 700 050.	32,5 x 48,0 x 10,5	4,2 (0,019)
Tablotherm – Insulated Tray without porcelain dishes, seal covers and pellet			
IT3753	Euronorm insulated tray – Empty	37,0 x 53,0 x 10,5	3,1 (0,024)
IT3253	Gastronorm insulated tray – Empty	32,5 x 48,0 x 10,5	2,4 (0,019)
Porcelain dishes			
122 400 050	Two compartment menu plate. Outside ø 254 mm. Capacity 750 ml. White.		
122 500 050	Multiple-use bowl. Outside ø 120 mm. Capacity 400 ml. White.		
Food covers, light gray, polypropylene with integrated rubber seal			
122 600 050	For two compartment menu plate		
122 700 050	For multiple-use bowl		
Pellet System			
165PW	SMC pellet ø 16,5 cm		
Menu card			
112 430 000	Yellow 100 x 70 mm		
ITPD3753, IT3753 Color: Two Tone Green.			
ITPD3253, IT3253 Color: Two Tone Gray.			
165PW Color: A42 165PW Case Pack: 1 Each.			

Meal Delivery Carts for Tray Service (20 Tray Capacity)



- Use to transport meal trays from the kitchen to acute care patients, nursing home residents or correctional facility inmates.
- Ensures optimal food quality and short delivery times.
- Tough, one-piece, double-wall polyethylene carts are easy to clean and won't rust, dent, crack, chip or break.
- Units have light-weight non-insulated ABS doors.

Colors: Grey (180), Slate Blue (401), Granite Grey (191), Granite Green (192), Granite Sand (194).

MDC1520T16 and MDC1418T16 are covered by U.S. Patent D 398,727.



Marine rail is designed for use during service, not transport.



Low Profile

SPECIFICATIONS	MDC1520S20	MDC1418S20
TRAY SIZE	38 x 51,5 cm	36 x 46 cm
TRAYS PER CART	20	20
TRAYS PER COMPARTMENT	10	10
RAILS PER COMPARTMENT	5	5
TRAYS PER RAIL	2	2
RAIL SPACING	13,9 cm	13,9 cm
NUMBER OF DOORS	2	2
NUMBER OF COMPARTMENTS	2	2
NUMBER OF MENU CLIPS	2	2
MENU CLIPS - LOCATION	1 per door	1 per door
HANDLES - TYPE AND LOCATION	Molded in, each end	Molded in, each end
CASTER TYPE	12,7 cm, 2 end swivel w/brake; 20,3 cm, 2 rigid on center axle	12,7 cm, 2 swivel w/brake, 2 rigid, offset
LATCHES	2 internal nylon friction	2 internal nylon friction, 1 external lock hook
EXTERNAL DIMENSIONS W x D x H	140 x 96,5 x 110 cm	123,5 x 83 x 112 cm
INTERNAL DIMENSIONS W x D x H	53,5 x 77 x 70 cm	47 x 71,5 x 74 cm
UNIT WEIGHT	74,93 Kg	71,5 Kg
CASE KG (CUBE M ³)	77 (1,577)	72,76 (1,176)

Case Pack: 1

Meal Delivery Carts For Tray Service (16 & 30 Tray Capacity)











Tall Profile

SPECIFICATIONS	MDC1520T30	MDC1520T16	MDC1418T30	MDC1418T16
TRAY SIZE	38 x 51,5 cm	38 x 51,5 cm	36 x 46 cm	36 x 46 cm
TRAYS PER CART	30	16	30	16
TRAYS PER COMPARTMENT	10	8	10	8
RAILS PER COMPARTMENT	10	4	10	4
TRAYS PER RAIL	1	2	1	2
RAIL SPACING	12,7 cm	13,3 cm	12,7 cm	13,3 cm
NUMBER OF DOORS	3	1	3	1
NUMBER OF COMPARTMENTS	3	2	3	2
NUMBER OF MENU CLIPS	5	1	5	1
MENU CLIPS - LOCATION	Each door, each end	Back of cart	Each door, each end	Back of cart
HANDLES - TYPE AND LOCATION	Heavy-duty nylon, mounted 1 per end	Molded-in, 1 per end	Heavy-duty nylon, mounted 1 per end	Molded-in, 1 per end
CASTER TYPE	15,2 cm, 2 rigid, 4 swivel w/brake, offset	15,2 cm, 2 rigid, 2 swivel w/brake	15,2 cm, 2 rigid, 4 swivel w/brake, offset	15,2 cm, 2 rigid, 2 swivel w/brake
LATCHES	Friction catch, Transit latch*	Large paddle latch external security latches	Friction catch, Transit latch*	Large paddle latch
EXTERNAL DIMENSIONS W x D x H	152,5 x 74,5 x 162 cm	78 x 100 x 148 cm	152,5 x 74,5 x 162 cm	71,5 x 93 x 148 cm
INTERNAL DIMENSIONS W x D x H	39 x 53,5 x 127 cm	52,5 x 77,5 x 55 cm	37 x 55 x 127 cm	46,5 x 75 x 55 cm
REQUIRED DOOR WIDTH	77 cm	79 cm	77 cm	73 cm
UNIT WEIGHT	102 Kg	67 Kg	104 Kg	58 Kg
CASE KG (CUBE M ³)	106,14 (2,0)	71,53 (1,299)	127 (1,86)	63,81 (1,117)

Case Pack: 1 Colors (All carts with Light Cream Door): Grey (180), Slate Blue (401), Granite Grey (191), Granite Green (192), Granite Sand (194).

*Stainless steel transit latch at top of each door. For lighter-duty applications, 30-tray carts may be ordered without the steel transit latches by using product code MDC1520T30NL or MDC1418T30NL.

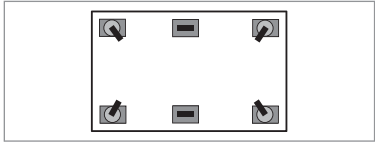
Meal Delivery Carts For Tray Service

	Tall Profile Units, 30 Trays MDC1520T30, MDC1418T30	Tall Profile Units, 16 Trays MDC1520T16, MDC1418T16	Low Profile Units, 20 Trays MDC1520S20, MDC1418S20
Latches	 <p>Hidden friction catch on each door for easy closing.</p>	 <p>Large stainless steel paddle latches are easy to open, rust free and removable for easy cleaning.</p>	 <p>Internal friction catch on each door. External stainless steel hooks to lock contents.</p>
Handles	 <p>Heavy-duty nylon handles are securely mounted and nested into each end.</p>	 <p>Molded in handles for easy transporting.</p>	 <p>Molded in handles on each end for smooth transporting.</p>
Casters	 <p>Four swivel, corner casters are slightly offset to keep cart stable on uneven surfaces, while two fixed, center casters provide a tighter turning radius.</p>	 <p>Rigid casters on front and swivel on the back offer solid stability and easy maneuvering.</p>	 <p>MDC1520S20 MDC1418S20 Two caster configurations offer excellent stability and smooth transporting.</p>

Meal Delivery Cart - Tall Profile, Correctional

Modified for use in correctional facilities. Holds 60 each 1411CW or 1411CP Cambro Base Trays with 853 Insert Trays or 60 each 10146DCW or 10146DCP Separator Compartment Trays. Added features include handle security screws, lock blocks on door hinge pins and heavy-duty casters.



SPECIFICATIONS	MDC1411T60
TRAY SIZE	36,5 x 26,8 cm Base Tray 1411CW and 1411CP
TRAYS PER CART	60
TRAYS PER COMPARTMENT	20
RAILS PER COMPARTMENT	10
TRAYS PER RAIL	2
RAIL SPACING	12,7 cm
NUMBER OF COMPARTMENTS	3
MENU CLIPS	None
HANDLES - TYPE AND LOCATION	Heavy-duty aluminum with security screws, black finish, 1 per end
CASTER TYPE	15,2 cm heavy-duty casters, 5 cm wide tread, 2 swivel no brake, 2 rigid
LATCHES	Internal friction catch, 2 per door, transit latch*
EXTERNAL DIMENSIONS W x D x H	153 x 75 x 162 cm
INTERNAL DIMENSIONS W x D x H	37 x 55 x 127 cm
REQUIRED DOOR WIDTH	76,2 cm
UNIT WEIGHT KG	104 Kg
CASE KG (CUBE M ³)	126,4 (1,86)
Case Pack: 1	*Stainless steel transit latch at top of each door.

WAREWASHING, HANDLING & STORAGE



Cambox® Bussing Boxes



Regal



CODE	1120CBR	1520CBR
DESCRIPTION	Four Compartment Cutlery Box	Cambox
DIM. L x W x H	28,9 x 52 x 9,5 cm	38,9 x 50,6 x 12,5 cm
CASE KG (CUBE M³)	10,22 (0,075)	11 (0,1)

Case Pack: 12 Colors: Black (110), Dark Brown (131).



CODE	1621CBR	21155CBR	21157CBR	1722CBR
DESCRIPTION	Cambox	Cambox	Cambox	Cambox
DIM. W x L x H	39,7 x 52 x 12,4 cm	38,7 x 51,4 x 12,5 cm (incl. handle)	38,6 x 51,2 x 17,6 cm	42,9 x 55,6 x 12,1 cm
CASE KG (CUBE M³)	19 (0,1)	12,58 (0,112)	15,97 (0,128)	12,81 (0,118)

Case Pack: 12 Colors: Black (110), Dark Brown (131).

Polyethylene



CODE	415CBP	912CBP	1120CBP	1520CBP & 1520CBPF*
DESCRIPTION	Cutlery Box	Utility Box	Four Compartment Cutlery Box	Cambox
DIM. W x L x H	11,3 x 36 x 10,3 cm	23 x 30,6 x 13 cm	28,9 x 52 x 9,5 cm	38,9 x 50,6 x 12,5 cm
CASE KG (CUBE M³)	1,18 (0,021)	5,3 (0,036)	9 (0,073)	9,07 (0,096)

Case Pack: 12 Colors: Black (110), Dark Brown (131), Light Grey (180). * 1520CBPF is identical to our current 1520CBP except the internal surface is flat.



CODE	1621CBP	21155CBP	21157CBP	1722CBP
DESCRIPTION	Cambox	Cambox	Cambox	Cambox
DIM. L x W x H	39,7 x 52 x 12,4 cm	38,7 x 51,4 x 12,5 cm (incl. handle)	38,6 x 51,2 x 17,6 cm	42,9 x 55,6 x 12,1 cm
CASE KG (CUBE M³)	14,15 (0,110)	9,71 (0,091)	11,5 (0,11)	12 (0,1)

Case Pack: 12 Colors: Black (110), Dark Brown (131), Light Grey (180).

Box Covers



CODE	1520CBCP	1722CBCP	2115CBCP	2115CBCR
FITS	1520CBP	1722CBR, 1722CBP	21155CBP, 21157CBP	2115CBR, 21157CBR
DIM. W x L	40,6 x 52 cm	44 x 56,8 cm	39,4 x 52 cm	39,4 x 52 cm
CASE KG (CUBE M³)	5,93 (0,033)	6,06 (0,026)	7,5 (0,04)	7,5 (0,04)

Case Pack: 12 Color: White (148).



KD Service Cart And KD Utility Cart

- Versatile, durable and economically-priced carts.
- Marine rails and lightly-textured polypropylene shelves keep contents in place.
- Aluminum uprights ensure stability.
- Ships “knocked down” to minimize shipping costs.
- Easy to assemble.

Cart and Shelf Panel Set Colors:
Black (110), Speckled Grey (480).

Trash Container and Silverware Holder Color: Black (110).



Each BC340KD shelf holds one full-sized dish rack or two standard bus boxes.



Marine rails keep contents in place.

Optional shelf panels can be added at time of assembly to enclose three sides.

Sturdy aluminum uprights.

Four powder coated steel swivel casters provide quiet transport and steady maneuvering.

BC340KD

Durable, stain-resistant surface is easy to clean.



Shown with optional shelf panels on single shelf.

CODE	BC331KD	BC340KD
DESCRIPTION	Service Cart	Large Utility Cart
CASTER DIA./TYPE	10,2 cm, 4 swivel, no brake	12,7 cm, 4 swivel, no brake
OVERALL DIM. L x D x H	83,5 x 41,3 x 96,5 cm	101,5 x 54 x 95 cm
SHELF DIM. L x D x H	62 x 40 x 30 cm	80 x 52 x 29,8 cm
LOAD CAPACITY	136 Kg	180 Kg
CASE KG. (CUBE M ³)	10,89 (0,12)	17,7 (0,19)

Case Pack: 1

Optional Accessories



CODE	BC331KDTC	BC331KD5H	BC340KDP
DESCRIPTION	30 L Trash Container	9,5 L Silverware Holder	Single Shelf Panel Set (for BC340KD only).
DIM. W x D x H	33 x 24 x 56 cm	33 x 24 x 18,5 cm	80,3 x 45 x 29,8 cm
CASE KG (CUBE M ³)	2,25 (0,054)	1,02 (0,016)	2,8 (0,02)

Case Pack: 1

Service Carts

- All-purpose versatile, durable and dependable workhorses.
- Ideal for use on the receiving dock or setting up and bussing tables.
- Made of one-piece, polyethylene with molded-in handles and shelves.
- Choose from models with open or enclosed sides.

Colors: Black (110), Slate Blue (401), Dark Brown (131), Coffee Beige (157), Grey (180), Granite Grey (191), Granite Green (192).

BC225, BC2254S, BC11TC and BC1115SH can be shipped by parcel carrier.



Open Carts



CODE	BC225	BC2254S	BC235
CASTER DIA./TYPE	7,6 cm, 2 fixed, 2 swivel, 1 w/brake	7,6 cm, 4 swivel, 1 w/brake	12,7 cm, 2 fixed, 2 swivel, 1 w/brake
OVERALL DIM. L x D x H	71 x 41 x 82 cm	71 x 41 x 82 cm	95 x 55 x 88 cm
SHELF DIM. L x D x H	56 x 39,5 x 29 cm	56 x 39,5 x 29 cm	79 x 52 x 29 cm
LOAD CAPACITY	159 Kg	159 Kg	227 Kg
CASE KG (CUBE M ³)	18 (0,26)	17,6 (0,26)	28,73 (0,499)

Case Pack: 1



CODE	BC2354S	BC230	BC2304S
CASTER DIA./TYPE	12,7 cm, 4 swivel, 1 w/brake	12,7 cm, 2 fixed, 2 swivel, 1 w/brake	12,7 cm, 4 swivel, 1 w/brake
OVERALL DIM. L x D x H	95 x 55 x 88 cm	84,5 x 51 x 88 cm	84,5 x 51 x 88 cm
SHELF DIM. L x D x H	79 x 52 x 29 cm	69 x 49,5 x 29 cm	69 x 49,5 x 29 cm
LOAD CAPACITY	227 Kg	227 Kg	227 Kg
CASE KG (CUBE M ³)	29,5 (0,5)	26 (0,42)	26,04 (0,42)

Case Pack: 1

Enclosed Carts



CODE	BC330	BC3304S
CASTER DIA./TYPE	12,7 cm, 2 fixed, 2 swivel, 1 w/brake	12,7 cm, 4 swivel, 1 w/brake
OVERALL DIM. L x D x H	84,5 x 51 x 88 cm	84,5 x 51 x 88 cm
SHELF DIM. L x D x H	69 x 46,5 x 29 cm	69 x 46,5 x 29 cm
LOAD CAPACITY	227 Kg	227 Kg
CASE KG (CUBE M ³)	29,11 (0,417)	29,57 (0,42)

Case Pack: 1

Optional Accessories



CODE	BC11TC*	BC1115SH*
DESCRIPTION	42 L Trash Container	6,6 L Silverware Holder
DIMENSIONS W x D x H	35 x 20,6 x 53,7 cm	36,8 x 15,2 x 13,7 cm
CASE KG (CUBE M ³)	3 (0,06)	1,5 (0,02)

Case Pack: 1 * BC11TC & BC1115SH will not fit KD Service or Utility Carts. BC11TC & BC1115SH are available in Black (110) and Dark Brown (131) only.

Camdollies®

- Use to transport anything from stacks of sheet pans to catering equipment.
- Reduce employee lifting and carrying, reducing possible injury.
- Made of extremely durable plastic that will not dent, crack, rust or corrode.
- Heavy-duty casters maneuver easily over all types of terrain.
- For heavy transport needs, select models with handles and rear Big Wheels.

Colors: Coffee Beige (157), Dark Brown (131), Black (110), Slate Blue (401), Gray (180).
CDR2020, CDR2020H Color: Soft Gray (151).

Caster Type

- A:** 12,7 cm Casters: 2 fixed, 2 swivel, 1 with brake.
B: 7,6 cm Casters: 4 swivel, no brakes.
C: 25,4 cm Rear Big Wheels, 2 front 12,7 cm swivel casters, 1 with brake.
D: 8,9 cm Casters: 4 swivel, no brakes.

Available Parcel Carrier Delivery:

CDR2020, CDR2020H, CD2020, CD1420, CD2028, CD1313, CD1327, CD100, CD160, CD200, CD300, CD400, CD1826PDB, 2030UT & 400STP.

Camdollies Case Pack: 1

*CDR2020H Not NSF Listed.

For Dish Racks

EXTERNAL DIM. W x D x H 54 x 54 x 20 cm
INTERIOR DIM. W x D 53 x 53 cm
CASE KG. (CUBE M³) 5,3 (0,03)



CDR2020

159 Kg CAPACITY	D CASTER TYPE
---------------------------	-------------------------



EXTERNAL DIM. W x D x H 54 x 59 x 94 cm
INTERIOR DIM. W x D 53 x 53 cm
CASE KG. (CUBE M³) 9,7 (0,1)



CDR2020H*
(with powder coated handle)

159 Kg CAPACITY	D CASTER TYPE
---------------------------	-------------------------



EXTERNAL DIM. W x D x H 57 x 57 x 21 cm
INTERIOR DIM. W x D 51 x 51 cm
CASE KG. (CUBE M³) 7,63 (0,076)



CD2020

159 Kg CAPACITY	B CASTER TYPE
---------------------------	-------------------------



For 46 x 66 cm Trays and Sheet Pans

EXTERNAL DIM. W x D x H 51 x 80 x 98 cm
INTERIOR DIM. W x D 47 x 66 cm
CASE KG. (CUBE M³) 15 (0,36)



CD1826H

Holds: UPC101

136 Kg CAPACITY	A CASTER TYPE
---------------------------	-------------------------



EXTERNAL DIM. W x D x H 59,5 x 85 x 93 cm
INTERIOR DIM. W x D 47 x 66 cm
CASE KG. (CUBE M³) 22 (0,52)



CD1826HB

Holds: UPC101

136 Kg CAPACITY	C CASTER TYPE
---------------------------	-------------------------



EXTERNAL DIM. W x D x H 56,5 x 61,5 x 93,5 cm
INTERIOR DIM. W x D 51,5 x 51,5 cm
CASE KG. (CUBE M³) 15 (0,32)



CD2020H

159 Kg CAPACITY	B CASTER TYPE
---------------------------	-------------------------



For Pizza Dough Boxes

Also See Pizza Dough Boxes page 134

EXTERNAL DIM. W x D x H 50,5 x 71 x 26 cm
INTERIOR DIM. W x D 44,5 x 64,5 cm
CASE KG. (CUBE M³) 10 (0,1)



CD1826PDB
(Optional Strap Available)

Holds: DB18263CW, DB18266CW, DB18263P

136 Kg CAPACITY	A CASTER TYPE
---------------------------	-------------------------



EXTERNAL DIM. W x D x H 66 x 68,5 x 93 cm
INTERIOR DIM. W x D 52 x 52,5 cm
CASE KG. (CUBE M³) 21 (0,44)



CD2020HB

159 Kg CAPACITY	C CASTER TYPE
---------------------------	-------------------------



Camdollies® For Camcarriers® and Camtainers®

EXTERNAL DIM. W x D x H 50 x 73 x 27 cm
INTERIOR DIM. W x D 44 x 66,5 cm
CASE KG. (CUBE M³) 8 (0,1)



CD100

Holds: 100MPC, UPC100, UC250, UC500, 250LCD, 350LCD, 500LCD

136 Kg CAPACITY	A CASTER TYPE
---------------------------	-------------------------



EXTERNAL DIM. W x D x H 50 x 84 x 92 cm
INTERIOR DIM. W x D 45 x 67,5 cm
CASE KG. (CUBE M³) 15,33 (0,36)



CD100H

Holds: 100MPC, UC250, UC500, 250LCD, 350LCD, 500LCD

159 Kg CAPACITY	A CASTER TYPE
---------------------------	-------------------------



EXTERNAL DIM. W x D x H 60 x 83,5 x 93 cm
INTERIOR DIM. W x D 44,5 x 68 cm
CASE KG. (CUBE M³) 21 (0,52)



CD100HB

Holds: 100MPC, UPC100, UC250, UC500, 250LCD, 350LCD, 500LCD

159 Kg CAPACITY	C CASTER TYPE
---------------------------	-------------------------



EXTERNAL DIM. W x D x H 42 x 62 x 26,5 cm
INTERIOR DIM. W x D 36 x 56 cm
CASE KG. (CUBE M³) 9 (0,06)



CD160

Holds: UPC140, UPC160, UPC180, UPCS140, UPCS160, UPCS180, UPCSS160

136 Kg CAPACITY	A CASTER TYPE
---------------------------	-------------------------



EXTERNAL DIM. W x D x H 49 x 65 x 26,5 cm
INTERIOR DIM. W x D 43 x 59 cm
CASE KG. (CUBE M³) 8 (0,09)



CD300

Holds: 300MPC, 1318MTC, UC1000, 1000LCD

136 Kg CAPACITY	A CASTER TYPE
---------------------------	-------------------------



EXTERNAL DIM. W x D x H 61 x 89,5 x 93 cm
INTERIOR DIM. W x D 56 x 72,5 cm
CASE KG. (CUBE M³) 16 (0,49)



CD1826MTC

Holds: 1826MTC

159 Kg CAPACITY	A CASTER TYPE
---------------------------	-------------------------



EXTERNAL DIM. W x D x H 70 x 88,5 x 93,5 cm
INTERIOR DIM. W x D 55,5 x 72,5 cm
CASE KG. (CUBE M³) 18,96 (0,61)



CD1826MTCB

Holds: 1826MTC

159 Kg CAPACITY	C CASTER TYPE
---------------------------	-------------------------



EXTERNAL DIM. W x D x H 48,5 x 76,5 x 92 cm
INTERIOR DIM. W x D 43 x 59 cm
CASE KG. (CUBE M³) 15 (0,34)



CD300H

Holds: 300MPC, 1318MTC, UC1000, 1000LCD

159 Kg CAPACITY	A CASTER TYPE
---------------------------	-------------------------



EXTERNAL DIM. W x D x H 60 x 76 x 92 cm
INTERIOR DIM. W x D 44 x 60 cm
CASE KG. (CUBE M³) 21 (0,51)



CD300HB

Holds: 300MPC, 1318MTC, UC1000, 1000LCD

159 Kg CAPACITY	C CASTER TYPE
---------------------------	-------------------------



EXTERNAL DIM. W x D x H 53 x 70 x 23 cm
INTERIOR DIM. W x D 46 x 63,5 cm
CASE KG. (CUBE M³) 8,89 (0,095)



CD400
(Shown with Optional Strap)

Holds: UPC400, UPCS400, UPCH400

136 Kg CAPACITY	A CASTER TYPE
---------------------------	-------------------------



Camdollies® for Milk Crates and #10 Can Cases

EXTERNAL DIM. W x D x H 41,5 x 55,5 x 20,5 cm
INTERIOR DIM. W x D 35,5 x 49,5 cm
CASE KG (CUBE M³) 7 (0,04)



CD1420

Holds: 35,6 x 48,3 cm Milk Crates and #10 Can Cases

159 Kg CAPACITY	B CASTER TYPE
---------------------------	-------------------------



EXTERNAL DIM. W x D x H 56 x 77 x 20,5 cm
INTERIOR DIM. W x D 50 x 71 cm
CASE KG (CUBE M³) 8,53 (0,09)



CD2028

Holds: 35,6 x 48,3 cm Milk Crates, #10 Can Cases and UPC101

159 Kg CAPACITY	B CASTER TYPE
---------------------------	-------------------------



EXTERNAL DIM. W x D x H 41 x 41 x 21,5 cm
INTERIOR DIM. W x D 35 x 35 cm
CASE KG (CUBE M³) 5,58 (0,03)



CD1313

Holds: 30 x 30 cm Milk Crates

114 Kg CAPACITY	B CASTER TYPE
---------------------------	-------------------------



EXTERNAL DIM. W x D x H 41 x 74,5 x 21,5 cm
INTERIOR DIM. W x D 35 x 68 cm
CASE KG (CUBE M³) 6,79 (0,072)



CD1327

Holds: 30 x 30 cm Milk Crates and #10 Can Cases

136 Kg CAPACITY	B CASTER TYPE
---------------------------	-------------------------



Utility Trucks

- Use for transporting loads of up to 272 Kg.
- Large platforms for convenient loading and built-in handles for easy maneuvering.
- All models feature 12,7 cm heavy-duty casters bolted into molded-in metal backing plates.

Colors: Coffee Beige (157), Dark Brown (131), Black (110), Slate Blue (401), Gray (180), Brick Red (402), Kentucky Green (519).

Casters: 12,7 cm, 2 fixed, 2 swivel, 1 with brake.

Utility Trucks Case Pack: 1



2030UT
(With chrome handle)

EXTERNAL DIM. W x D x H 50 x 81,5 x 98 cm
LOAD PLATFORM 50 x 75 cm
CASE KG (CUBE M³) 14,06 (0,093)

272 Kg CAPACITY	NSF
---------------------------	------------



EXTERNAL DIM. W x D x H 60,5 x 106 x 92 cm
LOAD PLATFORM 60,5 x 91 cm
CASE KG (CUBE M³) 20,5 (0,64)



2436UTH

272 Kg CAPACITY	NSF
---------------------------	------------



EXTERNAL DIM. W x D x H 60,5 x 106 x 92 cm
LOAD PLATFORM 60,5 x 91 cm
CASE KG (CUBE M³) 21 (0,64)



2436UTHS
(Includes two straps)

272 Kg CAPACITY	NSF
---------------------------	------------



Camdolly® Strap for CD400 and CD1826PDB Camdollies

CODE	400STP
CASE KG (CUBE M³)	0,55 (0,003)

Case Pack: 1



Tray & Dish Cart / Tray & Silver Cart

Tray & Dish Cart

- Open storage compartment holds a wide variety of plates and trays.
- Use with or without detachable cutlery station.
- Made of easy-to-clean polyethylene that won't rust, peel or corrode.
- Rounded, molded-in corners protect furniture and walls.
- Molded-in handles and heavy-duty 15,2 cm swivel casters ease maneuvering.

Colors: Slate Blue (401), Coffee Beige (157), Dark Brown (131), Grey (180), Granite Grey (191), Granite Green (192).

15,2 cm Casters: All swivel, 2 with brake.

Vinyl cover is not NSF listed.



Flatware cylinders and vinyl cover included with TDCR12.

Use the vinyl cover for sanitary storage (included).

CODE	DESCRIPTION	CASE KG (CUBE M ³)
TDCR12	Cart & Rack Combination	40,5 (0,63)
TDC2029*	Cart only	28,12 (0,514)
CR12	Cutlery Rack only	11 (0,12)
FWC56	Flatware Cylinder	1,38 (0,012)

Case Pack: 1 FWC56 Case Pack: 12

CODE	DESCRIPTION	EXTERIOR DIMENSIONS L x W x H
TDCR12	Cart & Rack Combination	97 x 58 x 105 cm
TDC2029*	Cart	97 x 56,5 x 87 cm
CR12	Cutlery Rack	84 x 58 x 23 cm

*TDC2029 is not available in Black (110).

Tray & Silver Cart

- Use to neatly organize trays and accessories for self-service.
- Includes eight clear Camwear® food pans to hold flatware, napkins and non-perishable condiments.
- Protective vinyl cover included.

Colors: Slate Blue (401), Coffee Beige (157), Dark Brown (131), Grey (180), Granite Grey (191), Granite Green (192).

15,2 cm Casters: All swivel, 2 with brake.

Vinyl cover is not NSF listed.



TC1418

CODE	DESCRIPTION	CASE PACK	CASE KG (CUBE M ³)
TC1418	Cart w/Pans & Vinyl Cover	1	38 (0,55)

CODE	EXTERIOR DIMENSIONS L x W x H	WEIGHT CAPACITY	MAXIMUM TRAY SIZE	TRAY CAPACITY
TC1418	82 x 54 x 116 cm	227 Kg	36 x 46 cm	180-200 in two stacks

Camwear® Polycarbonate Pans for self-serve top:

PAN QUANTITY, SIZE	CAPACITY
4 each, ½ size x 10 cm deep	Holds 100 knives, 100 spoons, 80 forks
4 each, ⅓ size x 10 cm deep	Holds variety of condiments

Use the vinyl cover for sanitary storage (included).



S-Series Adjustable Dish Caddy

- Store one size dish or a combination of different sizes in a single caddy.
- Features easy-to-adjust column towers.

ADCS Colors: Black (110), Slate Blue (401), Speckled Grey (480), Dark Brown (131).

Casters: Two 12,7 cm, swivel with brakes and two 25,4 cm easy wheels.

Vinyl cover included. Not NSF listed.

For square and rectangular plates, please contact Cambro for suggested use.



Holds plates and bowls from 11,7 to 33 cm

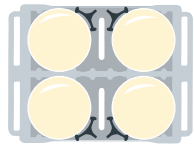

Plate sizes: ϕ 23,5 cm to 33 cm
4 Columns (60 each)
Total Capacity: 240

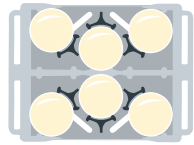

Plate sizes: ϕ 18,42 cm to 23,5 cm
6 Columns (60 each)
Total Capacity: 360

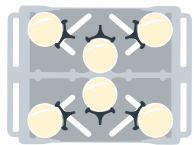
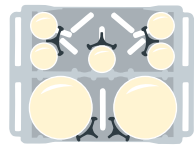
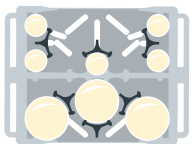

Plate sizes: ϕ 14,6 cm to 18,42 cm
6 Columns (45 each)
Total Capacity: 270



2 Columns: ϕ 23,5 cm to 33 cm (60 each)
5 Columns: ϕ 12,6 cm (45 each)
Total Capacity: 345



3 Columns: ϕ 18,42 cm to 23,5 cm (60 each)
5 Columns: ϕ 11,75 cm (45 each)
Total Capacity: 405

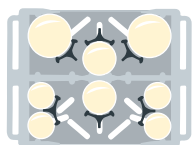

2 Columns: ϕ 18,42 cm to 23,5 cm (60 each)
2 Columns: ϕ 14,6 cm to 18,42 cm (45 each)
4 Columns: ϕ 12,6 cm (45 each)
Total Capacity: 390

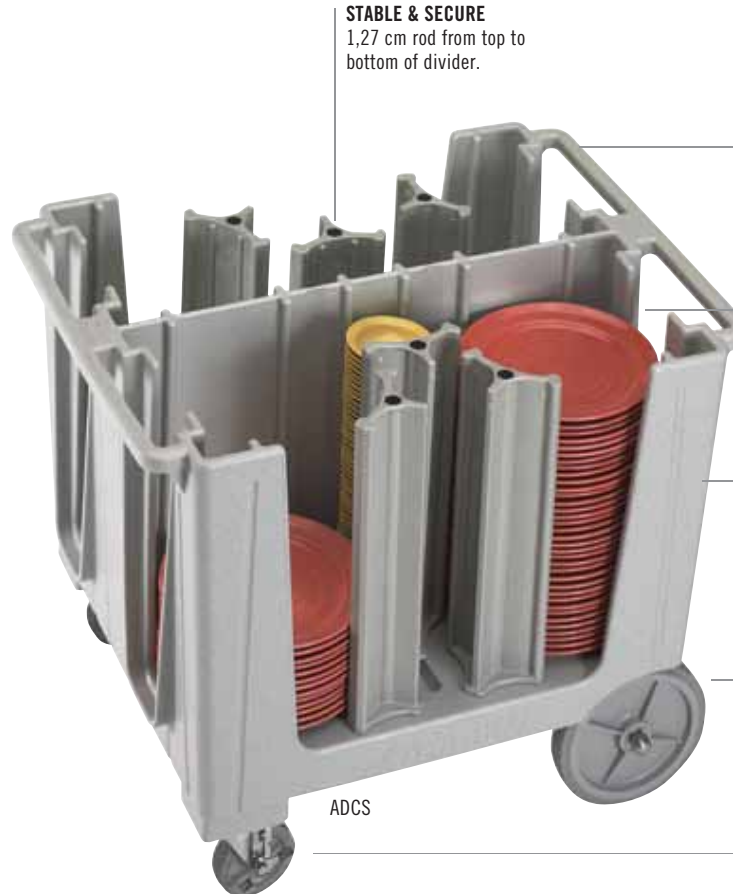

STABLE & SECURE
1,27 cm rod from top to bottom of divider.

EASY TO MANEUVER
Ergonomic molded-in handles on both ends.

HOLDING CAPACITY
49,5 cm storage columns hold 45-60 plates per stack.

EXTREMELY DURABLE
Heavy duty polyethylene construction protects china from chipping. Won't chip, crack or rust.

REAR WHEELS
25,4 cm non-marking Easy Wheels.

FRONT CASTERS
12,7 cm swivel with brake.



A 2 cm plated steel rear axle allows for 227 Kg load capacity.



Vinyl cover included with every dolly for sanitary storage.

CODE	ADCS
NUMBER OF DIVIDERS	6
PLATES PER COLUMN	Approximately 45-60
OVERALL DIMENSIONS W x L x H	73 x 96 x 81 cm
CASE KG (CUBE M ³)	60,69 (0,62)

Case Pack: 1 Plate size range from 11,7 to 33 cm.

Versa Dish Caddies™, Dish Caddies, Adjustable Tray & Dish Cart



Versa Dish Caddies

- Secure, high-capacity storage to protect both square and round plates.
- Durable, polyethylene exterior will not rust, crack, dent or chip.
- Poker chip style offers greater access for easy plate removal.
- A 2 cm plated steel rear axle allows for 227 Kg load capacity.
- Molded-in handles on both ends for easy transporting.
- 12,7 cm front swivel casters with brake and 25,4 cm non-marking rear wheels ease maneuvering.
- No assembly required.

Colors: Black (110), Slate Blue (401), Dark Brown (131), Speckled Grey (480).

Casters: 2, 12,7 cm swivel with brakes and two 25,4 cm Easy Wheels.

Vinyl cover included. Not NSF listed.

DCS950 is covered by U.S. Patent D 603,120S. DCS1125 is covered by U.S. Patent D 625,894.



DCS950 holds 5 columns of 45-60 round plates up to 24,1 cm or 4 to 5 columns of square plates up to 20,5 cm.

DCS1125 holds 4 columns of 45-60 round plates up to 28,6 cm or square plates up to 24,1 cm.

Poker Chip Style Dish Caddies

- Use to store and protect valuable dishware.
- Dividers are molded into the body in a standard poker chip design.
- Made of durable polyethylene that protects plates from chipping.
- Open access from two sides for easy loading and unloading.
- Rounded corners inside and out protect dishware, furniture and walls.

Colors: Black (110), Slate Blue (401), Dark Brown (131), Granite Grey (191).

Casters: 2, 12,7 cm swivel with brakes and two 25,4 cm Easy Wheels.

Vinyl cover included. Not NSF listed.



DC700



Sanitary plastic cover included and recommended for protecting clean dinnerware & trays. Replacement covers are available through the Cambro Replacement Parts List at www.cambro.com.

Adjustable Tray & Dish Cart

- Use to store a wide variety of plates and trays.
- Move two adjustable dividers into position easily to secure trays and plates.
- Made of durable polyethylene that cushions plates and trays to prevent chipping.
- Easy to clean and won't dent, rust, chip or break.

Colors: Black (110), Slate Blue (401), Coffee Beige (157), Dark Brown (131), Grey (180), Granite Grey (191), Granite Green (192).

Casters: 15,2 cm all swivel, 2 with brake.

Maximum load capacity: 227 Kg.

Vinyl cover included. Not NSF listed.



TDC30



Vinyl included with every dolly for sanitary storage.



Versa Dish Caddies™

CODE	DCS950	DCS1125
PLATE SIZE RANGE (ROUNDS)	21,3 - 24,1 cm	24,4 - 28,6 cm
PLATE SIZE RANGE (SQUARES)	18,4 - 20,5 cm	21,3 - 24,1 cm
COLUMNS PER CADDY	5, 45-60 plates per col.	4, 45-60 plates per col.
OVERALL DIMENSIONS W x L x H	69 x 78 x 81 cm	69 x 78 x 81 cm
CASE KG (CUBE M³)	40,65 (0,47)	40,45 (0,47)

Case Pack: 1

Vinyl cover included with every dolly for sanitary storage.



Poker Chip Style Dish Caddies

CODE	DC575	DC700	DC825
PLATE SIZE RANGE	14,6 cm	14,9 - 17,8 cm	18,1 - 21 cm
COLUMNS PER CADDY	6, 45-60 plates per col.	6, 45-60 plates per col.	4, 45-60 plates per col.
OVERALL DIMENSIONS W x L x H	83 x 60 x 81 cm	83 x 60 x 81 cm	73 x 60,5 x 81,5 cm
CASE KG (CUBE M³)	29 (0,41)	29 (0,41)	26,5 (0,36)

Case Pack: 1



Poker Chip Style Dish Caddies

CODE	DC1225
PLATE SIZE RANGE	28,9 - 31,1 cm
COLUMNS PER CADDY	4, 45-60 plates per col.
OVERALL DIMENSIONS W x L x H	83 x 70 x 81,5 cm
CASE KG (CUBE M³)	32,5 (0,5)

Case Pack: 1

Adjustable Tray & Dish Cart



CODE	TDC30
NUMBER OF DIVIDERS	2
PLATES PER COLUMN	Approximately 45-60
TRAYS PER COLUMN	80 Trays: 36 x 46 cm
OVERALL DIMENSIONS W x L x H	59 x 99 x 88 cm
CASE KG (CUBE M³)	34,78 (0,531)

Case Pack: 1



Camrack® 4-in-1 Warewashing System

The Camrack® System will protect glassware and keep it clean until the next event, eliminating the need for rewashing.

Efficient Washing

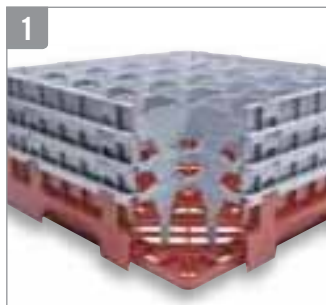

Open inside compartments provide thorough circulation of water and cleaning solutions and promote quick and thorough drying. Long-lasting polypropylene Camracks are built to withstand chemicals and high temperatures up to 200°F (93°C).

Sanitary Storage



Closed outer walls keep fingers and contaminants out and reduce risk of breakage and injury. The Camrack cover and Camdolly make this system completely enclosed. Glassware stays clean when in storage, so operators will only have to wash items once.

Inventory Control



A variety in base rack colors help identify at a glance both contents and quantity per rack. Available in 10 colors.

Safe, Sanitary Transportation



Camracks can be transported across large campuses or to off-site locations in one single unit. Easy to grip handles and smooth overlapping sides facilitate safe handling.

Camrack Cover Seals from the Top and Camdolly® Seals from the Bottom.



Camracks interstack with racks from major manufacturers.

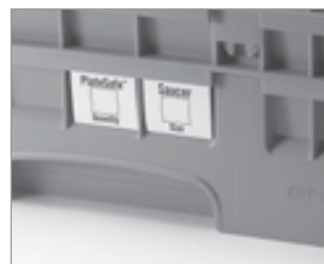

Content labeling options include one-color custom hot stamping or pre-printed clips that are added at factory during assembly.



Camracks are covered by one or more of the following patents: Full Base Dish Rack D412,607. Half Base Dish Rack D404,176. Half Dish Rack Extender D400,321. Enlarged Dish Rack Extender D399,614. Dish Rack with Extender 5,934,486 Utility Patent. Pronged Base Dish Rack D403,472.

Full Size Camracks® for Stemware & Tumblers

These racks offer complete protection for all your delicate and valuable stemware and tumblers, from washing and handling to stacking, storing and transporting.

Choose the correct dishrack:

1. Measure the maximum diameter of your glass (stemware or tumbler) to determine the number of compartments.
2. Measure the maximum height of your glass (stemware or tumbler) to the top edge of the rim to determine the compartment height.

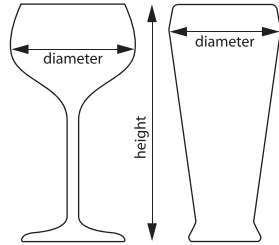

Camrack Sizing Guides are available at www.cambro.com under Resource Center.

9 COMPARTMENT

 	14,8 cm MAXIMUM DIAMETER	9 cm MAXIMUM HEIGHT	13,2 cm	17,4 cm	21,6 cm	25,8 cm	30 cm
	CODE	9S318	9S434	9S638	9S800	9S958	9S1114
	CASE PACK	5	4	3	2	2	2
	CASE KG (CUBE M ³)	12,71 (0,196)	13,27 (0,196)	12,37 (0,181)	9,98 (0,138)	11,39 (0,169)	12,96 (0,196)
	EXT. RACK HEIGHT	14,3 cm	18,4 cm	22,5 cm	26,7 cm	30,8 cm	34,9 cm

16 COMPARTMENT

 	10,9 cm MAXIMUM DIAMETER	9 cm MAXIMUM HEIGHT	11 cm	13,2 cm	15,2 cm	17,4 cm	19,4 cm
	CODE	16S318	16S418	16S434	16S534	16S638	16S738
	CASE PACK	5	5	4	4	3	3
	CASE KG (CUBE M ³)	12,33 (0,196)	12,99 (0,196)	12,98 (0,196)	13,52 (0,196)	12,17(0,181)	12,57 (0,181)
	EXT. RACK HEIGHT	14,3 cm	14,3 cm	18,4 cm	18,4 cm	22,5 cm	22,5 cm
	21,6 cm MAXIMUM HEIGHT	23,8 cm	25,8 cm	27,8 cm	30 cm	32 cm	
	CODE	16S800	16S900	16S958	16S1058	16S1114	16S1214
	CASE PACK	2	2	2	2	2	2
	CASE KG (CUBE M ³)	9,86 (0,138)	10,13 (0,138)	11,27 (0,169)	11,54 (0,169)	12,86 (0,196)	13,13 (0,196)
	EXT. RACK HEIGHT	26,7 cm	26,7 cm	30,8 cm	30,8 cm	34,9 cm	34,9 cm

Base Rack Colors:

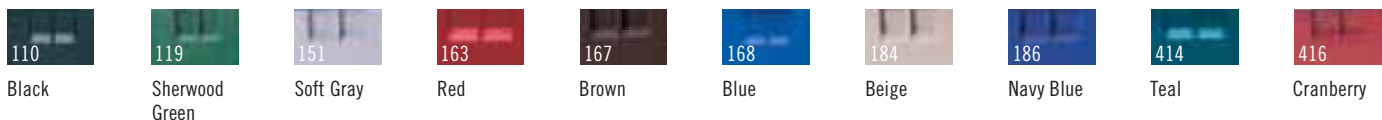



Extender Color: Soft Grey (151). ** Compartment Extenders cannot be added. Personalization available. See Camrack personalization and color coding page. For a more accurate color representation, call your sales rep for actual color chips. Contact Customer Service for all special orders.



Full Size Camracks® for Stemware & Tumblers

20 COMPARTMENT



Match a glass to a rack at www.cambro.com:resourcecenter/camracks.

 <p>9,84 cm MAXIMUM DIAMETER</p>	 MAXIMUM HEIGHT	9 cm	13,3 cm	17,5 cm	21,6 cm	25,8 cm	30 cm
	CODE	20S318	20S434	20S638	20S800	20S958	20S1114
	CASE PACK	5	4	3	2	2	2
	CASE KG (CUBE M³)	12,77 (0,196)	13,56 (0,196)	12,77 (0,181)	10,41 (0,138)	11,89 (0,169)	13,59 (0,196)
	EXT. RACK HEIGHT	14,3 cm	18,4 cm	22,5 cm	26,7 cm	30,8 cm	34,9 cm

25 COMPARTMENT





 <p>8,7 cm MAXIMUM DIAMETER</p>	 MAXIMUM HEIGHT	9 cm	11 cm	13,2 cm	15,2 cm	17,4 cm	19,4 cm
	CODE	25S318	25S418	25S434	25S534	25S638	25S738
	CASE PACK	5	5	4	4	3	3
	CASE KG (CUBE M³)	12,74 (0,196)	13,67 (0,196)	13,51 (0,196)	14,29 (0,196)	12,71 (0,181)	13,30 (0,181)
	EXT. RACK HEIGHT	14,3 cm	14,3 cm	18,4 cm	18,4 cm	22,5 cm	22,5 cm
	 MAXIMUM HEIGHT	21,6 cm	23,8 cm	25,8 cm	27,8 cm	30 cm	32 cm
	CODE	25S800	25S900	25S958	25S1058	25S1114	25S1214
	CASE PACK	2	2	2	2	2	2
	CASE KG (CUBE M³)	10,32 (0,138)	10,71 (0,138)	11,83 (0,169)	12,22 (0,169)	13,52 (0,196)	13,91 (0,196)
	EXT. RACK HEIGHT	26,7 cm	26,7 cm	30,8 cm	30,8 cm	34,9 cm	34,9 cm

30 COMPARTMENT



 <p>7,94 cm MAXIMUM DIAMETER</p>	 MAXIMUM HEIGHT	9 cm	13,3 cm	17,5 cm	21,6 cm	25,8 cm	30 cm
	CODE	30S318	30S434	30S638	30S800	30S958	30S1114
	CASE PACK	5	4	3	2	2	2
	CASE KG (CUBE M³)	13,28 (0,196)	14,24 (0,196)	13,48 (0,181)	11,02 (0,138)	12,64 (0,169)	14,48 (0,196)
	EXT. RACK HEIGHT	14,3 cm	18,4 cm	22,5 cm	26,7 cm	30,8 cm	34,9 cm

Full Size Camracks® for Stemware & Tumblers











36 COMPARTMENT

 7,2 cm MAXIMUM DIAMETER 	 MAXIMUM HEIGHT	9 cm	11 cm	13,2 cm	15,2 cm	17,4 cm	19,4 cm
	CODE	36S318	36S418	36S434	36S534	36S638	36S738
	CASE PACK	5	5	4	4	3	3
	CASE KG (CUBE M ³)	13,26 (0,196)	14,42 (0,196)	14,31 (0,196)	15,18 (0,196)	13,60 (0,181)	14,25 (0,181)
	EXT. RACK HEIGHT	14,3 cm	14,3 cm	18,4 cm	18,4 cm	22,5 cm	22,5 cm
	 MAXIMUM HEIGHT	21,6 cm	23,8 cm	25,8 cm	27,8 cm	30 cm	32 cm
	CODE	36S800	36S900	36S958	36S1058	36S1114	36S1214
	CASE PACK	2	2	2	2	2	2
	CASE KG (CUBE M ³)	11,10 (0,138)	11,54 (0,138)	12,80 (0,169)	13,24 (0,169)	14,68 (0,196)	15,11 (0,196)
	EXT. RACK HEIGHT	26,7 cm	26,7 cm	30,8 cm	30,8 cm	34,9 cm	34,9 cm

49 COMPARTMENT

 6 cm MAXIMUM DIAMETER 	 MAXIMUM HEIGHT	9 cm	13,2 cm	17,4 cm	21,6 cm	25,8 cm	30 cm
	CODE	49S318	49S434	49S638	49S800	49S958	49S1114
	CASE PACK	5	4	3	2	2	2
	CASE KG (CUBE M ³)	14,03 (0,196)	15,30 (0,196)	14,63 (0,181)	11,98 (0,138)	13,87 (0,169)	15,94 (0,196)
	EXT. RACK HEIGHT	14,3 cm	18,4 cm	22,5 cm	26,7 cm	30,8 cm	34,9 cm

Base Rack Colors:

 110	 119	 151	 163	 167	 168	 184	 186	 414	 416
Black	Sherwood Green	Soft Gray	Red	Brown	Blue	Beige	Navy Blue	Teal	Cranberry

Extender Color: Soft Grey (151). ** Compartment Extenders cannot be added. Personalization available. See Camrack personalization and color coding page. For a more accurate color representation, call your sales rep for actual color chips. Contact Customer Service for all special orders.

Half Size Camracks® For Stemware & Tumblers

- Very effective for carrying less weight and for storing drinkware in space-restricted locations.
- Ideal for small under-counter glasswashers.



10HS434

8 COMPARTMENT

Match a glass to a rack at www.cambro.com:resourcecenter/camracks.

<p>10,3 cm MAXIMUM DIAMETER</p>	MAXIMUM HEIGHT	9 cm	13,2 cm	17,4 cm	21,6 cm	25,8 cm	30 cm
	CODE	8HS318	8HS434	8HS638	8HS800	8HS958	8HS1114
	CASE PACK	5	4	3	2	2	2
	CASE KG (CUBE M ³)	7,69 (0,093)	8,14 (0,100)	7,61 (0,093)	6,16 (0,078)	7,11 (0,087)	8,02 (0,093)
	EXT. RACK HEIGHT	14,3 cm	18,4 cm	22,5 cm	26,7 cm	30,8 cm	34,9 cm

10 COMPARTMENT

<p>8,8 cm MAXIMUM DIAMETER</p>	MAXIMUM HEIGHT	9 cm	13,2 cm	17,4 cm	21,6 cm	25,8 cm	30 cm
	CODE	10HS318	10HS434	10HS638	10HS800	10HS958	10HS1114
	CASE PACK	5	4	3	2	2	2
	CASE KG (CUBE M ³)	7,87 (0,093)	8,39 (0,100)	7,88 (0,093)	6,39 (0,078)	7,40 (0,087)	8,36 (0,093)
	EXT. RACK HEIGHT	14,3 cm	18,4 cm	22,5 cm	26,7 cm	30,8 cm	34,9 cm

17 COMPARTMENT

<p>7,3 cm MAXIMUM DIAMETER</p>	MAXIMUM HEIGHT	9 cm	13,2 cm	17,4 cm	21,6 cm	25,8 cm	30 cm
	CODE	17HS318	17HS434	17HS638	17HS800	17HS958	17HS1114
	CASE PACK	5	4	3	2	2	2
	CASE KG (CUBE M ³)	8,33 (0,093)	8,99 (0,100)	8,51 (0,093)	6,93 (0,078)	8,05 (0,087)	9,14 (0,093)
	EXT. RACK HEIGHT	14,3 cm	18,4 cm	22,5 cm	26,7 cm	30,8 cm	34,9 cm

Base Rack Colors:



119

Sherwood Green

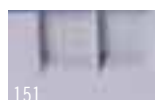

151

Soft Grey



167

Brown

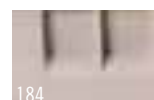

184

Beige



186

Navy Blue

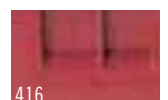

416

Cranberry

Extender Color: Soft Grey (151). Personalization available. See Camrack personalization and color coding page. For a more accurate color representation, call your sales rep for actual color chips. Contact Customer Service for all special orders.



Camrack® Full & Half Size Cup Racks

- Tilt feature drains water from mug or cup bases for quick and sanitary drying.





16C414



16 COMPARTMENT

11,1 X 11,1 cm COMPARTMENT DIMENSIONS 	MAX. HEIGHT 	6,6 cm	10,7 cm	14,9 cm
	CODE	16C258	16C414	16C578
	CASE PACK	6	5	4
	CASE KG (CUBE M³)	13,05 (0,136)	14,73 (0,196)	14,91 (0,196)
	EXT. RACK HEIGHT	10,1 cm	14,3 cm	18,4 cm



20 COMPARTMENT

11,1 X 8,8 cm COMPARTMENT DIMENSIONS 	MAX. HEIGHT 	6,6 cm	10,7 cm
	CODE	20C258	20C414
	CASE PACK	6	5
	CASE KG (CUBE M³)	13,28 (0,136)	14,76 (0,196)
	EXT. RACK HEIGHT	10,1 cm	14,3 cm

8 COMPARTMENT

10,4 X 11,3 cm COMPARTMENT DIMENSIONS 	MAX. HEIGHT 	6,6 cm	10,7 cm
	CODE	8HC258	8HC414
	CASE PACK	6	5
	CASE KG (CUBE M³)	7,32 (0,078)	8,46 (0,093)
	EXT. RACK HEIGHT	10,1 cm	14,3 cm

10 COMPARTMENT

10,4 X 8,8 cm COMPARTMENT DIMENSIONS 	MAX. HEIGHT 	6,6 cm	10,7 cm
	CODE	10HC258	10HC414
	CASE PACK	6	5
	CASE KG (CUBE M³)	7,59 (0,078)	8,96 (0,093)
	EXT. RACK HEIGHT	10,1 cm	14,3 cm

Glass and Cup Keepers

- Raised ribs for easy draining and drying.
- Holds 20 glasses or 12 cups per layer.

Color: Beige (133).



Max. Glass Inside
Rim Diameter:
GK2000: 6,6 cm

Max. Cup Inside
Rim Diameter:
KK1200: 7,4 cm

CODE	SIZE	CASE PACK	CASE KG (CUBE M³)
Glass Keepers			
GK2000 (Regal)	35,6 x 45,7 cm	12	7,5 (0,026)
Cup Keepers			
KK1200 (Regal)	35,4 x 45,4 cm	12	6,8 (0,02)

Base Cup Rack Color: Soft Grey (151). Extender Color: Soft Grey (151).
Personalization available. See Camrack personalization and color coding page.

Camrack® Base Racks

- For pots, pans, bowls and large prep, service and display items.
- Half racks work well for storing items at a wait station.



BR578

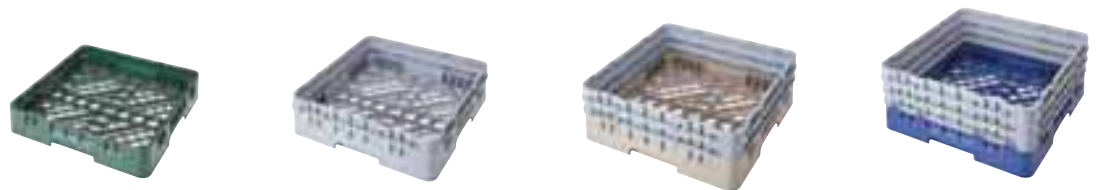

FULL SIZE BASE RACKS

	FULL BASE RACK	WITH 1 EXTENDER	WITH 2 EXTENDERS	WITH 3 EXTENDERS
CODE	BR258	BR414	BR578	BR712
INSIDE RACK HEIGHT	8,3 cm	12,4 cm	16,5 cm	20,6 cm
OUTSIDE RACK HEIGHT	10,1 cm	14,3 cm	18,4 cm	22,5 cm
CASE PACK	6	5	4	3
CASE KG (CUBE M³)	9,99 (0,136)	11,15 (0,196)	11,33 (0,196)	10,39 (0,181)



HALF SIZE BASE RACKS

	HALF BASE RACK	WITH 1 EXTENDER	WITH 2 EXTENDERS	WITH 3 EXTENDERS
CODE	HBR258	HBR414	HBR578	HBR712
INSIDE RACK HEIGHT	8,3 cm	12,4 cm	16,5 cm	20,6 cm
OUTSIDE RACK HEIGHT	10,1 cm	14,3 cm	18,4 cm	22,5 cm
CASE PACK	6	5	4	3
CASE KG (CUBE M³)	6,22 (0,078)	7,29 (0,093)	7,56 (0,100)	6,99 (0,093)

Hold Down Grid

Keeps lightweight smallwares in place during wash cycle. Use on full size Camrack base rack.



CRPHDG2878

	FULL SIZE HOLD DOWN GRID
CODE	CRPHDG2878
COLOR	Grey (000)
CASE PACK	6
CASE KG (CUBE M³)	4,60 (0,013)

Base Rack Colors:

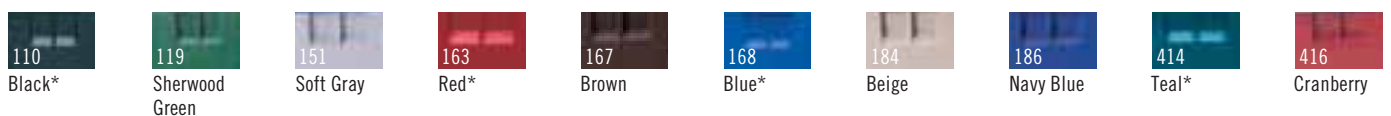

*Full size only. Extender Color: Soft Grey (151). Personalization available. See Camrack personalization and color coding page. For a more accurate color representation, call your sales rep for actual color chips. Contact Customer Service for all special orders.

Camrack® Full Size Peg Racks & Tray Rack

Standard 9 x 9 Peg Rack

- Designed to wash varying sized plates, bowls, trays and plate covers.
- Standard peg racks hold:
 - Eighteen 25,4 cm plates
 - Twelve 30,5 cm plates
 - Twenty-seven 19 cm plates
 - or
 - Nine 36 x 46 cm trays

5 x 9 Peg Rack

- Holds standard plates in one direction or deep plates, bowls and plate covers in the other direction.
- 5 spacing configuration holds up to ten 25,4 cm bowls, deep plates, platters or plate covers.
- 9 spacing configuration holds up to:

- Eighteen 25,4 cm plates
- Twelve 30,5 cm plates
- Twenty-seven 19 cm plates
- or
- Nine 36 x 46 cm trays

Open End Tray Rack

- Holds cafeteria trays or full-size sheet pans.
- Open-ended on one side for easy placement and removal of trays of all lengths.
- Holds up to nine trays upright.



	9 X 9 PEG RACK	9 X 9 PEG RACK WITH 1 EXTENDER	5 X 9 PEG RACK	5 X 9 PEG RACK WITH 1 EXTENDER	OPEN END TRAY RACK
CODE	PR314	PR500	PR59314	PR59500	OETR314*
INSIDE RACK HEIGHT	6,7 cm	10,8 cm	6,7 cm	10,8 cm	6,7 cm
OUTSIDE RACK HEIGHT	10,1 cm	14,3 cm	10,1 cm	14,3 cm	10,1 cm
CASE PACK	6	5	6	5	6
CASE KG (CUBE M³)	12,36 (0,136)	13,28 (0,196)	10,95 (0,136)	12,22 (0,196)	11,72 (0,136)

Color: Soft Grey (151). **Extender Color:** Soft Grey (151). Personalization available. See Camrack personalization and color coding page. For a more accurate color representation, call your sales rep for actual color chips. Contact Customer Service for all special orders. * Extenders cannot be added.

Camrack® Full & Half Size Flatware Racks & Cylinder

- 8 Compartment Basket fits into a Full or Half Size Base Rack. Wire handles slide down for easy storage.
- Flatware Cylinder fits into 9-Compartment Full Size Camrack and the Cambro Tray and Dish Cart, model TDCR12.

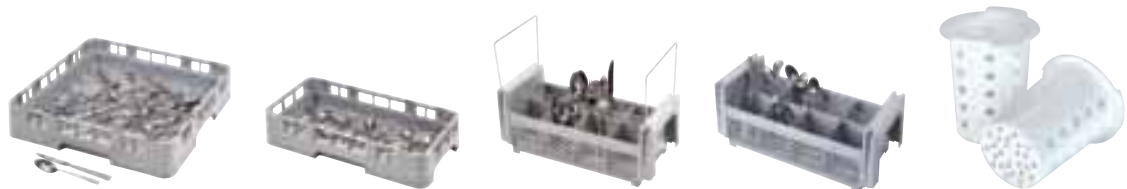

	FULL FLATWARE RACK	HALF FLATWARE RACK	8 COMPARTMENT HALF FLATWARE BASKET	8 COMPARTMENT HALF FLATWARE BASKET	FLATWARE CYLINDER
CODE	FR258	HFR258	8FB434* With Handles	8FBNH434* No Handles	FWC56
INSIDE RACK HEIGHT	6,7 cm	6,7 cm	11,1 cm	12 cm	wide 11,4 cm
OUTSIDE RACK HEIGHT	10,1 cm	10,1 cm	18,4 cm	18,4 cm	high 14 cm
CASE PACK	6	6	6	6	12
CASE KG (CUBE M³)	11,25 (0,136)	6,92 (0,078)	8,17 (0,105)	8,16 (0,105)	1,24 (0,012)

Color: Soft Grey (151). **Extender Color:** Soft Grey (151). **Flatware Cylinder Color:** White (148). Personalization available. See Camrack personalization and color coding page. For a more accurate color representation, call your sales rep for actual color chips. Contact Customer Service for all special orders. * Extenders cannot be added.

PlateSafe® Camrack® – Store and Transport Dishes. All-In-One.

- Effectively store and transport dinnerware.
- Vinyl-coated steel grids safely hold and separate plates within each rack.
- Add a Camdolly® and Cover to create a completely enclosed, sanitary storage unit between uses.
- Reduces breakage.
- Holds plates upright and securely in place.
- No need to transfer to dish caddies, reducing labor.



Transport racks to banquet area for quick set up.



CRP2878

PlateSafe Camracks

13 different styles of full size PlateSafe Camracks to transport plates from 10,1 to 31,7 cm in diameter.



Portable Sanitary Storage System

PlateSafe Camracks stacked on a Camdolly and covered with a Camrack Cover offers the best and most effective sanitary storage and transport system for dishes.



CRPH1656

Half Size PlateSafe Camrack

PLATE SIZE	10,1 – 12,7 cm	10,1 – 15,2 cm	12,7 – 15,2 cm	15,2 – 17,7 cm	15,2 – 19,3 cm	17,7 – 21,9 cm	22,8 – 26 cm	22,8 – 26,6 cm
MAX. PLATE HEIGHT	1,9 cm	5 cm	1,9 cm	1,9 cm	2,5 cm	2,5 cm	2,5 cm	4,4 cm
# OF PLATES	63	20	48	44	30	28	20	12
CODE	CRP631013	CRP201015	CRP481315	CRP441518	CRP301519	CRP281822	CRP202326	CRP122327
RACK SIZE	FULL	FULL	FULL	FULL	FULL	FULL	FULL	FULL
EXT. RACK HEIGHT	18,4 cm	18,4 cm	18,4 cm	22,5 cm	22,5 cm	26,7 cm	30,8 cm	30,8 cm
CASE PACK	2	2	2	2	2	1	1	1
CASE KG (CUBE M³)	10,18 (0,092)	7,91 (0,099)	8,35 (0,092)	14,25 (0,121)	8,85 (0,114)	5,87 (0,07)	6,39 (0,084)	5,03 (0,08)

PLATE SIZE	22,8 – 28,2 cm	22,8 – 27,9 cm	25,4 – 27,9 cm	26,6 – 31,7 cm	29,2 – 31,7 cm	12,7 – 17,5 cm
MAX. PLATE HEIGHT	4,4 cm	5,7 cm	2,5 cm	3,4 cm	2,5 cm	2,5 cm
# OF PLATES	12	9	19	14	18	16
CODE	CRP122328	CRP92328	CRP192528	CRP142732	CRP182832	CRPH161317
RACK SIZE	FULL	FULL	FULL	FULL	FULL	HALF
EXT. RACK HEIGHT	30,8 cm	30,8 cm	30,8 cm	34,9 cm	34,9 cm	18,4 cm
CASE PACK	1	1	1	1	1	4
CASE KG (CUBE M³)	6,84 (0,09)	6,53 (0,08)	6,99 (0,085)	7 (0,097)	6,55 (0,092)	10,67 (0,1)



* Full size only. Extender Color: Soft Gray (151). Personalization available. See Camrack personalization and color coding page. For a more accurate color representation, call your sales rep for actual color chips. Contact Customer Service for all special orders.

Store and Transport Glasses & Dishes

Camrack® Cover & Camdolly®

- Use to cover and protect full size Camrack dishracks filled with clean dishware.
- When used with a Camdolly, creates a portable sanitary storage system that protects contents between uses.
- Eliminates the use of messy, wasteful plastic wrap or vinyl covers.



	FULL RACK COVER
CODE	DRC2020
EXTERIOR DIMENSIONS	50 x 50 x 2,4 cm
CASE KG (CUBE M³)	0,91 (0,0098)

Case Pack: 1 Color: Grey (180).



	CAMDOLLY	CAMDOLLY WITH HANDLE
CODE	CDR2020	CDR2020H
INTERIOR DIMENSIONS	53 x 53 cm	53 x 53 cm
EXTERIOR DIMENSIONS	54,5 x 54,5 x 20,5 cm	54,5 x 59,5 x 94 cm
LOAD CAPACITY	159 Kg	159 Kg
CASE KG (CUBE M³)	5,3 (0,03)	9,7 (0,1)

Case Pack: 1 Color: Soft Grey (151). Casters: 10 cm casters, 4 swivel, no brakes.

Camrack IceExpress Glass Filler

- Dramatically reduces banquet set-up time.
- Fills 25 glasses with ice all at once.
- Reduces breakage and risk of contamination.
- Ice falls directly into glasses with no spills or drips.

CODE	EXTERIOR DIMENSIONS W x D x H	CASE KG (CUBE M³)
25SWGf	50,8 cm x 50,8 cm x 3,18 cm	1,13 (0,014)

Case Pack: 1 Color: Black (110).



Selecting The Right Camrack

Selecting the Right Camrack

Cambro offers multiple ways to help you quickly find the right Camrack:

1. www.cambro.com/mycamracks

To quickly find the correct Camrack, please visit www.cambro.com/mycamracks. Select the item you are sizing, enter the measurements and quantity of the item, and the right Camrack will appear on the page.

2. Cambro Catalog

Flip to the back of this section for a convenient stemware and glass sizing reference guide.

3. Cambro Sales Representatives

Contact your local Cambro representative and he or she will walk through your current ware handling system with you and specify Camracks®, dollies and covers that will fit your glasses and dishware. To find your local representative refer to the back section of this catalog, visit www.cambro.com and click on "Find a Sales Rep" on the lower left of your screen or call the Cambro Customer Service line: 31-168-707-210.

4. Send a Sample to Cambro

C.E.L. Customer Service.
c/o DHL Solutions, Tradeboulevard 3,
4761 RL Moerdijk, Holland.

Please be sure to include complete contact information and specify if you need full-size or half-size Camracks.

Choose the correct Camrack:

1. Measure the maximum diameter of the glass (stemware or tumbler) to determine the number of compartments.
2. Measure the maximum height of the glass (stemware or tumbler) to the top edge of the rim to determine the compartment height.

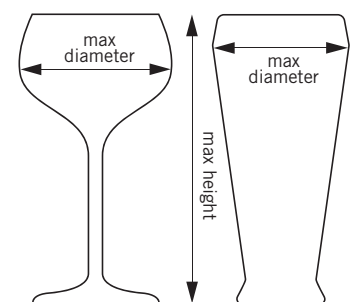

The Camrack® Component System

The Camrack System offers several choices for ordering the right Camracks now and as your needs change. Please consult with your sales representative or Cambro Customer Service for all special ordering and assembly directions.

Choose Between:

1. A complete selection of pre-assembled, ready to use Camracks listed in our catalog, or
2. Custom built special order Camracks for specific needs, or
3. Individual Camrack components for distributors to stock and build racks as needed.

Base Rack Colors:

Sherwood Green (119), Soft Grey (151), Brown (167), Beige (184), Navy Blue (186), Cranberry (416), Black (110)*, Red (163)*, Blue (168)*, Teal (414)*.

Base Cup Rack Color: Soft Grey (151).

Extender Color: Soft Grey (151).

Personalization available.

Full Base Racks are covered by U.S. Patent D 412,607.

Half Base Racks are covered by U.S. Patent D 404,176.

* Full size only.

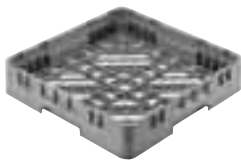

BR = Full Size Base Rack

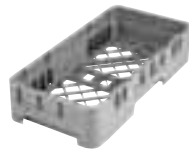

HBR = Half Size Base Rack

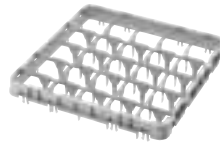

E1 = Full Size Full Drop Compartment Extender

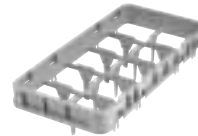

HE1 = Half Size Full Drop Compartment Extender

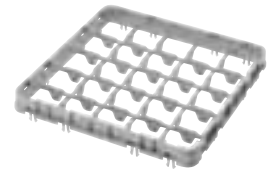

E2 = Full Size Half Drop Compartment Extender



HE2 = Half Size Half Drop Compartment Extender

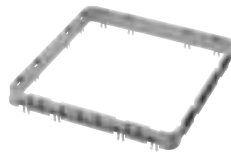

E3 = Full Size Open Extender

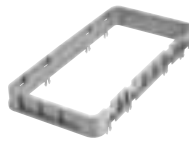

HE3 = Half Size Open Extender

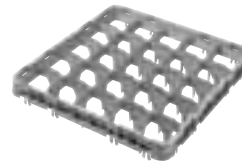

E4 = Full Size Full Drop Stemware Extender

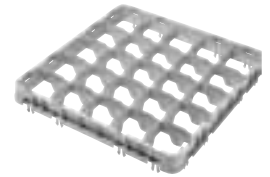

E5 = Full Size Half Drop Stemware Extender

Only E3 extenders may be added to E4's and E5's.

Camracks Components

CODE	DESCRIPTION	EXTERIOR DIMENSIONS	COMPARTMENT	INSIDE RACK HEIGHT	CASE PACK	CASE KG (CASE M ³)
Full Size Base Racks						
BR258*	Full Base Rack	500 x 500 x 101 mm	457 x 457 mm	67 mm	6	9,99 (0,136)
Half Size Base Racks						
HBR258	Half Base Rack	500 x 250 x 101 mm	464 x 213 mm	67 mm	6	6,22 (0,078)
Full Size Base Cup Racks						
16C258	16-Compartment Full Cup Rack	500 x 500 x 101 mm	111 x 111 mm	67 mm	6	13,05 (0,136)
20C258	20-Compartment Full Cup Rack	500 x 500 x 101 mm	111 x 89 mm	67 mm	6	13,28 (0,136)
Half Size Base Cup Racks						
8HC258	8-Compartment Half Cup Rack	500 x 250 x 101 mm	105 x 113 mm	67 mm	6	7,32 (0,078)
10HC258	10-Compartment Half Cup Rack	500 x 250 x 101 mm	105 x 89 mm	67 mm	6	7,59 (0,078)
Full Size Full Drop Extenders – E1 and GE1						
9E1	9-Compartment Full Drop Extender	499 x 499 x 51 mm	150 x 150 mm	41 mm	12	11,49 (0,196)
16E1	16-Compartment Full Drop Extender	499 x 499 x 51 mm	111 x 111 mm	41 mm	12	10,57 (0,196)
20GE1	20-Compartment Full Drop Extender	499 x 499 x 51 mm	98 x 98 mm	41 mm	12	11,70 (0,207)
25E1	25-Compartment Full Drop Extender	499 x 499 x 51 mm	89 x 89 mm	41 mm	12	11,55 (0,196)
30GE1	30-Compartment Full Drop Extender	499 x 499 x 51 mm	79 x 79 mm	41 mm	12	12,88 (0,207)
36E1	36-Compartment Full Drop Extender	499 x 499 x 51 mm	73 x 73 mm	41 mm	12	12,71 (0,196)
49E1	49-Compartment Full Drop Extender	499 x 499 x 51 mm	62 x 62 mm	41 mm	12	14,65 (0,196)

The Camrack® Component System

CODE	DESCRIPTION	EXTERIOR DIMENSIONS	COMPARTMENT	INSIDE RACK HEIGHT	CASE PACK	CASE KG (CASE M ³)
Full Size Half Drop Extenders – E2						
9E2	9-Compartment Half Drop Extender	499 x 499 x 51 mm	150 x 150 mm	41 mm	12	9,81 (0,196)
16E2	16-Compartment Half Drop Extender	499 x 499 x 51 mm	111 x 111 mm	41 mm	12	9,87 (0,196)
20E2	20-Compartment Half Drop Extender (for cups only)	499 x 499 x 51 mm	111 x 89 mm	41 mm	12	10,08 (0,196)
20GE2	20-Compartment Half Drop Extender	499 x 499 x 51 mm	98 x 98 mm	41 mm	12	10,61 (0,207)
25E2	25-Compartment Half Drop Extender	499 x 499 x 51 mm	89 x 89 mm	41 mm	12	10,46 (0,196)
30GE2	30-Compartment Half Drop Extender	499 x 499 x 51 mm	79 x 79 mm	41 mm	12	11,43 (0,207)
36E2	36-Compartment Half Drop Extender	499 x 499 x 51 mm	73 x 73 mm	41 mm	12	11,60 (0,196)
49E2	49-Compartment Half Drop Extender	499 x 499 x 51 mm	62 x 62 mm	41 mm	12	12,75 (0,196)
Full Size Open Extender – E3						
E3	Open Extender	499 x 499 x 51 mm	457 x 457 mm	41 mm	12	7,67 (0,156)
Full Size Full Drop Extenders – E4						
16E4	16-Compartment Full Drop Extender	499 x 499 x 51 mm	111 x 111 mm	41 mm	12	12,15 (0,196)
25E4	25-Compartment Full Drop Extender	499 x 499 x 51 mm	89 x 89 mm	41 mm	12	13,78 (0,196)
36E4	36-Compartment Full Drop Extender	499 x 499 x 51 mm	73 x 73 mm	41 mm	12	15,58 (0,196)
Full Size Half Drop Extenders – E5						
16E5	16-Compartment Half Drop Extender	499 x 499 x 51 mm	111 x 111 mm	41 mm	12	11,49 (0,196)
25E5	25-Compartment Half Drop Extender	499 x 499 x 51 mm	89 x 89 mm	41 mm	12	12,80 (0,196)
36E5	36-Compartment Half Drop Extender	499 x 499 x 51 mm	73 x 73 mm	41 mm	12	14,22 (0,196)
Half Size Full Drop Extenders – HE1						
8HE1	8-Compartment Full Drop Extender	502 x 252 x 51 mm	105 x 113 mm	41 mm	12	6,40 (0,100)
10HE1	10-Compartment Full Drop Extender	502 x 252 x 51 mm	105 x 89 mm	41 mm	12	6,83 (0,100)
17HE1	17-Compartment Full Drop Extender	502 x 252 x 51 mm	74 mm diameter	41 mm	12	7,92 (0,100)
Half Size Half Drop Extenders – HE2						
8HE2	8-Compartment Half Drop Extender	502 x 252 x 51 mm	105 x 113 mm	41 mm	12	6,18 (0,100)
10HE2	10-Compartment Half Drop Extender	502 x 252 x 51 mm	105 x 89 mm	41 mm	12	6,50 (0,100)
17HE2	17-Compartment Half Drop Extender	502 x 252 x 51 mm	74 mm diameter	41 mm	12	7,21 (0,100)
Half Size Open Extender – HE3						
HE3	Open Extender	502 x 252 x 51 mm	464 x 213 mm	41 mm	12	5,42 (0,100)
Base Rack Colors: Sherwood Green (119), Soft Gray (151), Brown (167), Beige (184), Navy Blue (186), Cranberry (416), Black (110)*, Red (163)*, Blue (168)*, Teal (414)*.						
Base Cup Rack Color: Soft Gray (151). Extender Color: Soft Gray (151). * Color available in full size only. All extenders are available in Soft Gray (151). All pre-assembled racks ship with Soft Gray (151) extenders. PlateSafe Grid Color: Gray (000).						

The Camrack® Component System

PLATESAFE® GRIDS USED TO BUILD PLATESAFE RACKS



PLATESAFE GRID CODE	CRPG6345	CRPG2046	CRPG4856	CRPG4467	CRPG3067	CRPG12911	CRPG20910
PLATESAFE RACK CODES	CRP631013	CRP201015	CRP481315	CRP441518	CRP301519	CRP122328	CRP202326
PLATE SIZE	10,2-12,7 cm	10,2-15,2 cm	12,7-15,2 cm	15,2-17,8 cm	15,2-19,4 cm	22,9-28,3 cm	22,9-26 cm
MAX. PLATE HEIGHT	1,91 cm	5,8 cm	1,91 cm	1,91 cm	2,54 cm	4,45 cm	2,54 cm
# OF PLATES PER RACK	63	20	48	44	30	12	20



PLATESAFE GRID CODE	CRPG12910	CRPG9911	CRPG191011	CRPG141012	CRPG181112	CRPG2878	HALF SIZE GRID CRPHG1656
PLATESAFE RACK CODES	CRP122327	CRP92328	CRP192528	CRP142732	CRP182832	CRP281822	CRPH161317
PLATE SIZE	22,9-26,7 cm	22,9-27,9 cm	25,4-27,9 cm	26,7-31,8 cm	27,9-31,8 cm	17,8-21,9 cm	12,7-17,5 cm
MAX. PLATE HEIGHT	4,45 cm	5,72 cm	2,54 cm	3,51 cm	2,54 cm	2,54 cm	2,54 cm
# OF PLATES PER RACK	12	9	19	14	18	28	16

Case Pack: 12



HOLD DOWN GRID
CRPHDG2878
CASE PACK: 6

Let's Get Personal – Personalized Camracks®

Personalize Camracks to identify contents at a glance for accurate inventory control and selection.

Hot stamp a custom logo, information or standard content symbols, and/or descriptions on two opposite, diagonal sides of any rack.

Or request the addition of pre-printed clips. Up to 4 Camrack or PlateSafe clips can be added only at time of assembly and require the addition of at least one extender.



IMPRINT COLOR-WHITE

PERSONALIZATION OPTIONS

HOT STAMP



CUSTOM LOGO AND/OR TEXT



STANDARD SYMBOL ONLY



STANDARD SYMBOL AND DESCRIPTION



STANDARD DESCRIPTION ONLY

CAMRACK CLIPS



WITH SYMBOL AND DESCRIPTION



HOW TO ORDER A SAMPLE

1. Contact your local Cambro rep to complete and submit a sample request form to Cambro.
 2. Select rack size, code and color. Imprint color - white only.
 3. Choose process A) Hot Stamp or B) Camrack Clips
 4. Indicate location of hot stamp and or clip on rack. Maximum hot stamp imprint size is 102 mm W x 31,7 mm H. Maximum hot stamp imprinting thickness per solid letter or logo should be no more than 102 mm wide.
 5. If selecting process A with a custom hot stamp, provide ready to use artwork, digital format only. Sample request form must be submitted to Cambro PRIOR to artwork being sent. If artwork is incomplete, graphic support services are available for ** per hour.
 6. E-mail artwork to Cambro Rep or to Cambro at personalizationcel@Cambro.com Title e-mail subject with logo name and provide contact info.
- File dimensions:** 100% reproduction size, 300dpi resolution.
- File type:** Adobe® Illustrator®, Photoshop®, or QuarkXpress®.
- File format:** JPEG, TIFF and EPS. Mail artwork on a CD-ROM to: CEL - Attn: C.E.L. Customer Service. c/o DHL Solutions, Tradeboulevard 3, 4761 RL Moerdijk, Holland.
7. Questions regarding artwork? Contact Tel: 31-168-707-210; Ireland Tel: 1800-509-046; for N.Ireland & UK, Tel: 0800-587-0057 or Fax: 31-168-707-211
 8. Signed approval form must be faxed to Cambro customer service prior to producing product. Approval form included with each sample rack.

PERSONALIZATION CHARGES

One Time Plate Charge	** for custom hot stamp only
Set-Up Charge	**
Sample Charge	**
Imprint Charge	** per side, 2 sides max.

FOR CLIPS

Drinkware or PlateSafe®, pre-printed ** each

** Contact your Cambro representative for pricing.

Standard Hot Stamp Symbols And/Or Descriptions

(also available on clips, symbol and description combined)

- | | |
|---|--|
|  Wine |  Cup |
|  Martini |  Champagne Flute |
|  Rock (footed style) |  Grande |
|  Beer Mug |  Goblet |
|  Hi-Ball |  Sorbet |
|  Hurricane |  Rock (tumbler style) |
|  White Wine |  Creamer |
|  Brandy |  Beer |
|  Water (footed style) |  Collins |
|  Coffee Mug |  Champagne |
|  Margarita |  Cordial |
|  Pilsner |  Ice Tea |
|  Red Wine |  Decanter |
|  Sherry |  Old Fashion |
|  Water (tumbler style) |  Flatware |

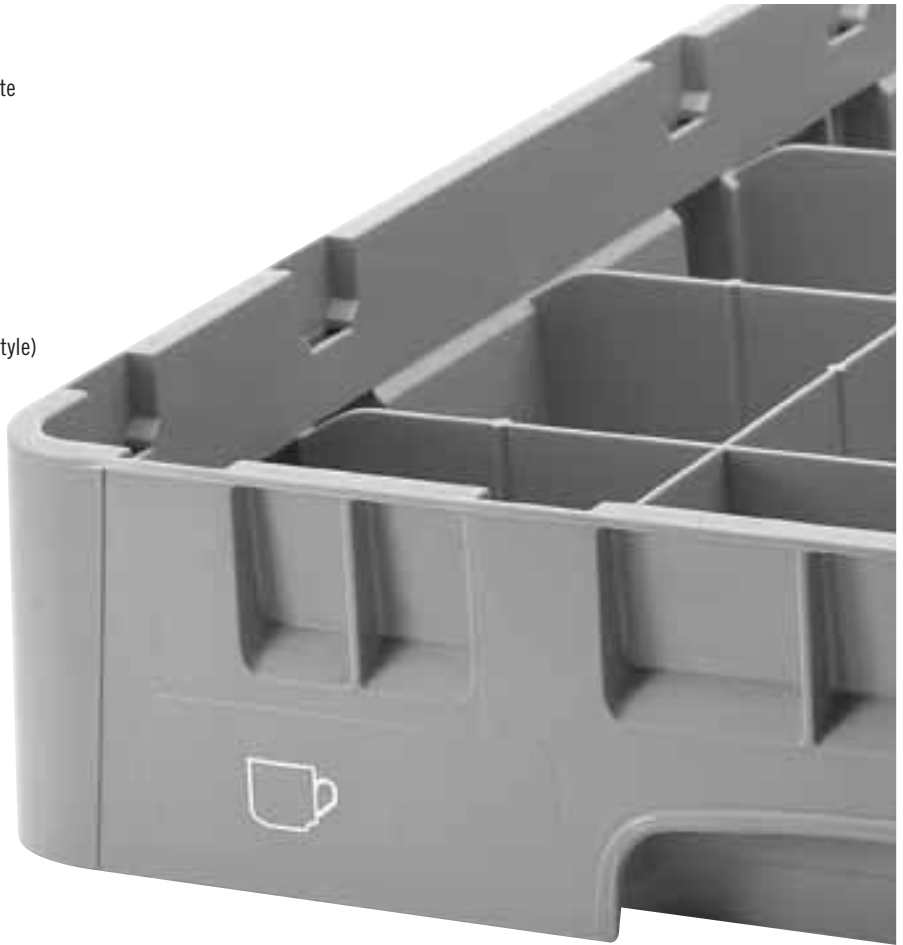

(Available in English Only)

Standard PlateSafe® Clips

DINNER



APPETIZER



SALAD



SOUP



PASTA



BREAD



SAUCER

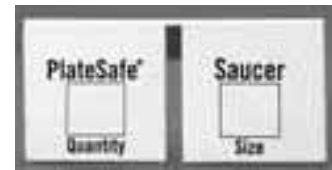

DESSERT



(Available in English Only)

Camrack® Cup Rack Reference Guide

16
FULL RACK
COMPARTMENT
11,1 x 11,1 cm

QUICK GUIDE
Full Size Cup Racks (C)

Maximum Cup Width	Number of Compartments	Maximum Cup Height		
		6,6 cm	10,7 cm	14,9 cm
11,1 cm	16	16C258	16C414	16C578
8,8 cm	20	20C258	20C414	NA

To determine Cup compartment size:
Turn cup or coffee mug upside down and place diagonally in square. Align handle with arrow in square. Cup or mug and handle must fit completely within boundaries of a square in order to ensure the right rack.

20
FULL RACK
COMPARTMENT
11,1 x 8 cm

10
HALF RACK
COMPARTMENT
10,4 x 8,8 cm

8
HALF RACK
COMPARTMENT
11,3 x 10,4 cm

QUICK GUIDE
Full Size Cup Racks (C)

Maximum Cup Width	Number of Compartments	Maximum Cup Height	
		6,6 cm	10,7 cm
10,4 cm	8	8HC258	8HC414
8,8 cm	10	10HC258	10C414

To Determine Cup Height:
Place base of cup or coffee mug on flat surface hold ruler vertically next to it to determine height in inches or millimeters. If the height is greater than 108 mm, additional 41 mm E2 and HE2 extenders may be ordered.

www.cambro.com

Stemware And Glass Sizing Reference Guide

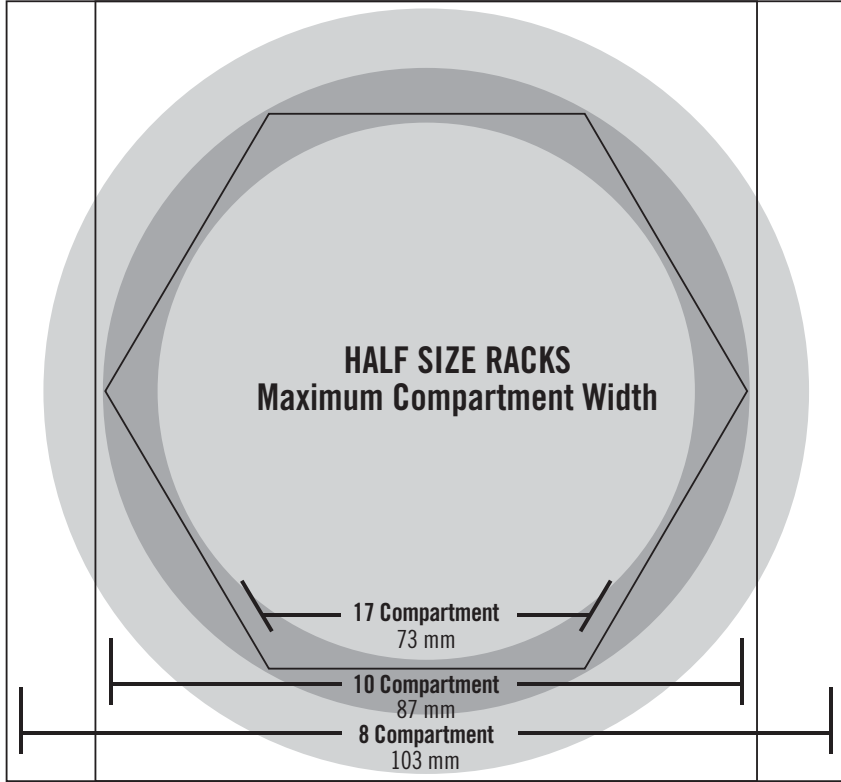

To Determine Compartment Size

• Half Size Racks:

Place glass or stemware upside down over circle chart. Look down on the glass. Whatever circle the largest diameter of the glass fits within will determine the number of compartments.

• Full Size Racks:

Place glass or stemware upside down over circle chart. Look down on the glass. Whatever circle the largest diameter of the glass fits within will determine the number of compartments.

Use the vertical guide marks at right to determine item height and appropriate rack number.

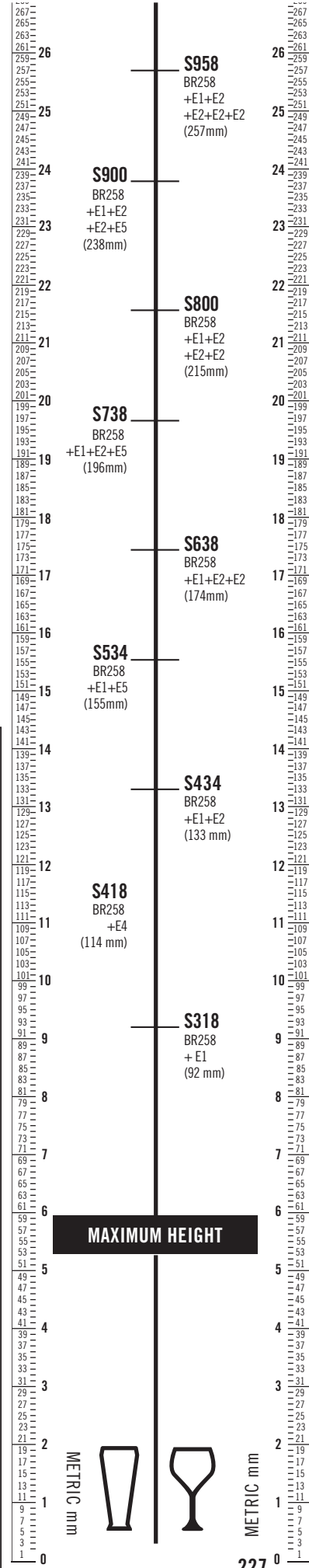
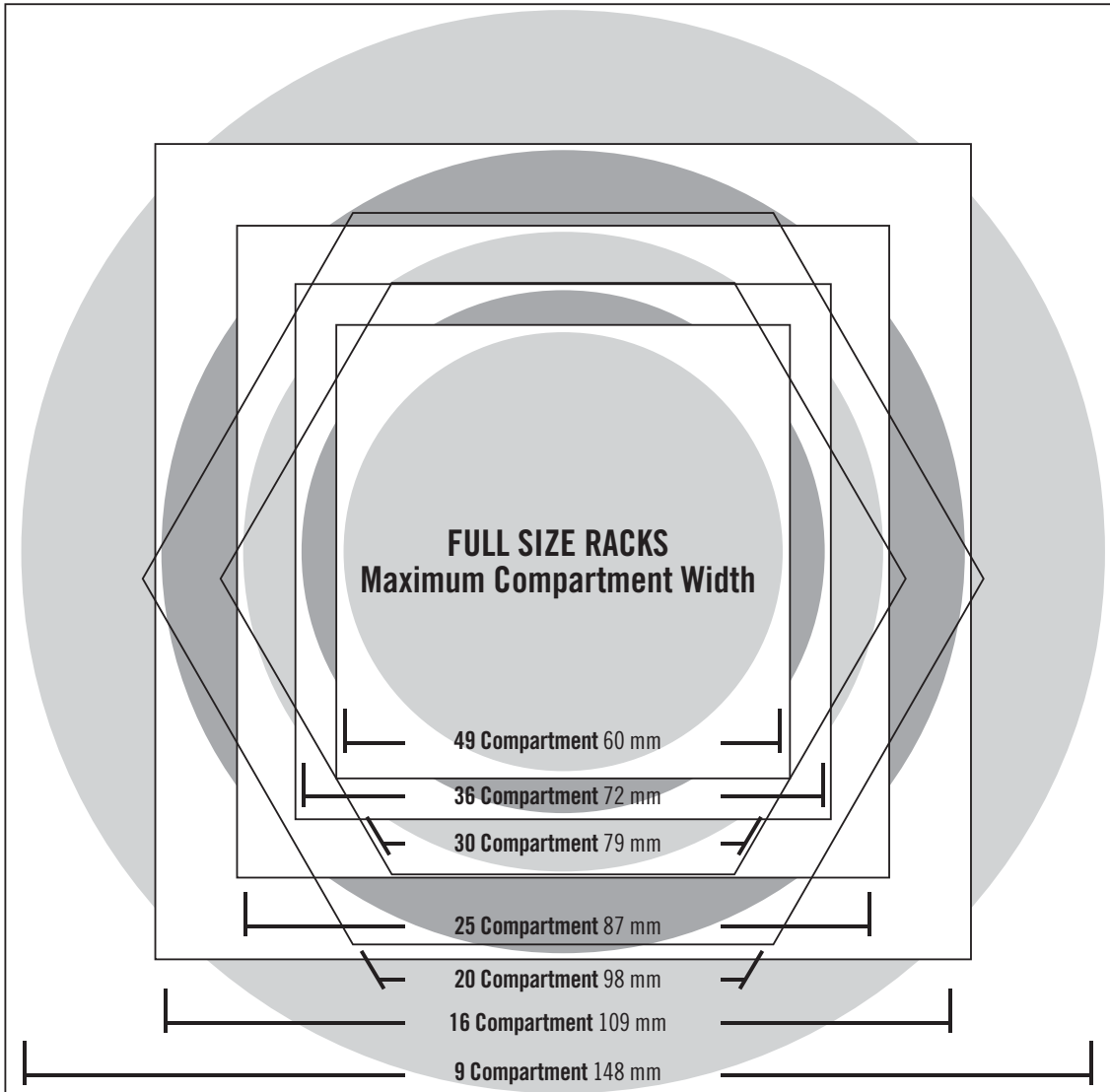

Alpha Numerical Listing

PRODUCT CODE NUMBER	PAGE	PRODUCT CODE NUMBER	PAGE	PRODUCT CODE NUMBER	PAGE	PRODUCT CODE NUMBER	PAGE
1000 (Group 1)	26	10CWGL	129	1210PW	171	12TGS	74
1000 (Group 3)	26	10CWL	51	1210PW	173	1300 (Group 1)	26
1000CW	53	10CWNR	51	1212SQVS	52	1300 (Group 3)	26
1000LCD	163	10HC258	216	1216 (Group 1)	25	1313 (Group 1)	27
1000LCDCVR	163	10HC258	221	1216 (Group 3)	25	1313 (Group 3)	27
1000VT	47	10HC414	216	1216CL	31	1318 (Group 1)	25
1005CW	53	10HE1	222	1216CT	32	1318 (Group 3)	25
1007CW	53	10HE2	222	1216CW	Discontinued 1/1/12	1318MT	47
100BC	150	10HPC	129	1216D (Group 1)	31	1318MTC	183
100BC1	150	10HPCH	129	1216D (Group 3)	31	1320TR (Group 1)	26
100BCS	150	10HPCHN	129	1216FF	40	1320TR (Group 3)	26
100CW	51	10HPD	127	1217FFH	40	13CLRCW	124
100LCD	163	10HS1114	215	12183CW	120	13CLRHP	128
100LCD	184	10HS318	215	12183P	121	1400 (Group 1)	26
100MCCW	136	10HS434	215	12186CW	120	1400 (Group 3)	26
100MPC	165	10HS638	215	12186P	121	1400CT	32
100MPCHL	165	10HS800	215	12189CW	120	1400CT - Designer Series	Discontinued 1/1/12
100VS	52	10HS958	215	12189P	121	14105CP	44
1010VS	52	10PPCH	131	1218CCW	120	14105CW	44
1012VS	52	10PPD	131	1218CP	121	1411CP	46
1013CRVS	Discontinued 1/1/12	10PPSC	131	1218DSCW	121	1411CW	46
1013CW	53	10SC	125	1218MT	47	1418 (Group 1)	25
1014 (Group 1)	25	10SC	129	1218SCW	120	1418 (Group 3)	25
1014 (Group 3)	25	1100 (Group 1)	26	1219D (Group 1)	31	1418TRCP	Discontinued 1/1/12
10145CW	44	1100 (Group 3)	26	1219D (Group 3)	31	1418TRCW	44
10146CW	42	1100CT	32	122 400 050	48	1418C (Group 1)	Discontinued 1/1/12
10146CW	44	1101CW	53	122 400 050	195	1418CL	31
10146DCP	45	1111SMVS	52	122 500 050	48	1418CT	32
10146DCPC	45	1111SQVS	52	122 500 050	195	1418CW	41
10146DCW	45	1116 (Group 1)	21	122 600 050	48	1418D (Group 1)	31
10146DCWC	45	1116 (Group 3)	25	122 600 050	195	1418D (Group 3)	31
1014CL	31	112 430 000	48	122 700 050	48	1418FF	40
1014CT	32	112 430 000	195	122 700 050	195	1418TR (Group 1)	26
1014FF	40	1120CBP	200	1220D (Group 1)	31	1418TR (Group 3)	26
1014VS	52	1120CBR	200	1220D (Group 3)	31	1418TRCW	41
1015 (Group 1)	25	1121TR (Group 1)	26	1222D (Group 1)	31	1418VC	30
1015 (Group 3)	21	1121TR (Group 3)	26	1222D (Group 3)	31	1418VC	193
1015MT	47	116VS	52	1224MT	47	1418VCC	30
10302MT	47	1200 (Group 1)	26	1227MT	47	1418VCC	193
1030MT	47	1200 (Group 3)	26	1230MT	47	1418VDC	30
103VS	52	1200CW	62	124VS	52	1418VDC	193
105VS	52	1200DIV	166	1252SLB250	133	1422TR (Group 1)	26
106VS	52	1200DIV	173	1252SLINB250	133	1422TR (Group 3)	26
107VS	Discontinued 1/1/12	1200P	61	12CW	123	14CW	123
10CW	51	1200P2	61	12HP	127	14HP	127
10CWC	125	1202CW	53	12HPC	128	14PP	131
10CWCH	125	120CWP	51	12RS12	150	150CW	51
10CWCHN	125	120VS	52	12SFSCW	112	1520 (Group 1)	25
10CWD	123	1210PW	166	12SFSP	113	1520 (Group 3)	25
10CWGL	125	1210PW	168	12SFSP	113	1520C (Group 1)	Discontinued 1/1/12

Alpha Numerical Listing

PRODUCT CODE NUMBER	PAGE	PRODUCT CODE NUMBER	PAGE	PRODUCT CODE NUMBER	PAGE	PRODUCT CODE NUMBER	PAGE
1520BCP	200	16C258	216	1826CCW	120	20CWLN	125
1520CBP	200	16C258	221	1826CL	31	20E2	222
1520CBPF	200	16C414	216	1826CLRCW	121	20GE1	221
1520CBR	200	16C578	216	1826CP	121	20GE2	222
1520CL	31	16CW	123	1826CT	32	20HPC	129
1520CT	32	16E1	221	1826DBC	182	20HPCCH	129
1520CW	41	16E2	222	1826DBCSP	182	20HPCHN	129
1520D (Group 1)	31	16E4	222	1826DSCW	121	20HPD	127
1520D (Group 3)	31	16E5	222	1826DTC	182	20HPL	129
1520TR (Group 1)	26	16HP	127	1826DTCSP	182	20HPLN	129
1520TR (Group 3)	26	16PP	131	1826LBC	183	20LPCWC	125
1520VC	30	16S1058	212	1826LBCSP	183	20LPCWD	123
1520VC	193	16S1114	212	1826LTC	183	20LPHPC	129
1520VCC	30	16S1214	212	1826LTC3	183	20LPHPD	127
1520VCC	193	16S318	212	1826LTCSP	183	20PPCH	131
1520VCRST	30	16S418	212	1826MT	47	20PPD	131
1520VCRST	193	16S434	212	1826MT	71	20PPSC	131
1520VDC	30	16S534	212	1826MTC	183	20S1114	213
1520VDC	193	16S638	212	1826SCCW	120	20S318	213
1525RST	32	16S738	212	1826STP	183	20S434	213
1550 (Group 1)	26	16S800	212	18CW	123	20S638	213
1550 (Group 3)	26	16S900	212	18PP	131	20S800	213
1550CT	32	16S958	212	18SFSCW	112	20S958	213
1596CP	43	1722CBCP	200	18SFSP	113	20SC	125
1596CW	43	1722CBP	200	18SFSP	113	20SC	129
15CLRCW	124	1722CBR	200	1950 (Group 1)	26	21155CBP	200
15CLRHP	128	17HE1	222	1950 (Group 3)	26	21155CBR	200
1600 (Group 1)	26	17HE2	222	1950CT	32	21157CBP	200
1600 (Group 3)	26	17HS1114	215	2000P	61	21157CBR	200
1600CT	32	17HS318	215	2000P2	61	2115CBCP	200
1600CT - Designer Series	Discontinued 1/1/12	17HS434	215	200BC	150	2115CBCR	200
1600CW	62	17HS638	215	200BC1	150	22CW	123
1600DIV	146	17HS800	215	200BCS	150	22HP	127
1600DIV	166	17HS958	215	200MCCW	136	22LPCW	123
1600DIV	173	1800CT	32	2025 (Group 1)	25	22LPHP	127
1600P	61	1800CT - Designer Series	Discontinued 1/1/12	2025 (Group 3)	25	22SFSCW	112
1600P2	61	1826 (Group 1)	25	2025MT	47	22SFSP	113
1621CBP	200	1826 (Group 3)	25	2030UT	205	22SFSP	113
1621CBR	200	182612CW	120	20C258	216	23CLRCW	124
1622 (Group 1)	25	182612P	121	20C258	221	23CLRHP	128
1622 (Group 3)	25	182615CW	120	20C414	216	23SL	133
16225 (Group 1)	25	182615P	121	20CC	61	23SLB250	133
16225 (Group 3)	25	18263CW	120	20FC	132	23SLB6250	133
1622CT	32	18263P	121	20CWC	125	23SLINB250	133
1622D (Group 1)	31	18266CW	120	20CWCH	125	240MPC	164
1622D (Group 3)	31	18266P	121	20CWCHN	125	2436UTH	205
1622VC	30	18268CLRCW	121	20CWD	123	2436UTHS	205
1622VC	193	18268CLRKIT	121	20CWGL	125	24CW	123
165PW	48	18269CW	120	20CWGL	129	24HP	127
165PW	195	18269P	121	20CWL	125	24LPCW	123

Alpha Numerical Listing

PRODUCT CODE NUMBER	PAGE	PRODUCT CODE NUMBER	PAGE	PRODUCT CODE NUMBER	PAGE	PRODUCT CODE NUMBER	PAGE
24LPH	127	30CWCH	125	36E1	221	44HP	127
24PP	131	30CWCHN	125	36E2	222	44PP	131
2500 (Group 1)	26	30CWD	123	36E4	222	45CW	51
2500 (Group 3)	26	30CWGL	125	36E5	222	46 (Group 1)	25
2500CT	32	30CWGL	129	36HP	127	46 (Group 3)	25
250LCD	163	30CWL	125	36PP	131	46CW	123
250LCDCVR	163	30CWLN	125	36S1058	214	46HP	127
25CLRCW	124	30GE1	221	36S1114	214	46PP	131
25CLRHP	128	30GE2	222	36S1214	214	49E1	221
25E1	221	30HPC	129	36S318	214	49E2	222
25E2	222	30HPCH	129	36S418	214	49S1114	214
25E4	222	30HPCHN	129	36S434	214	49S318	214
25E5	222	30HPD	127	36S534	214	49S434	214
25MCCW	136	30HPL	129	36S638	214	49S638	214
25S1058	213	30HPLN	129	36S738	214	49S800	214
25S1114	213	30PPCH	131	36S800	214	49S958	214
25S1214	213	30PPCHN	131	36S900	214	4FBRTT	142
25S318	213	30PPD	131	36S958	214	4SFSCW	112
25S418	213	30PPSC	131	3753 (Group 1)	27	4SFSP	113
25S434	213	30S1114	213	3753 (Group 3)	27	4SFSP	113
25S534	213	30S318	213	3753CL	31	500CW	62
25S638	213	30S434	213	3853 (Group 1)	27	500LCD	163
25S738	213	30S638	213	3853 (Group 3)	27	500LCDCVR	163
25S800	213	30S800	213	38CW	123	500P	61
25S900	213	30S958	213	400DIV	166	500P2	61
25S958	213	30SC	125	400DIV	168	50CW	51
25SWG	220	30SC	129	400DIV	171	50MCCW	136
2632 (Group 1)	27	3200P2	61	400DIV	173	5412CBP	150
2632 (Group 3)	27	3242 (Group 1)	27	400MCCW	136	5412CBP	184
26CF	132	3242 (Group 3)	27	400STP	168	55CWN	51
26CW	123	3253 (Group 1)	27	400STP	171	57 (Group 1)	25
26HP	127	3253 (Group 3)	27	400STP	177	57 (Group 3)	25
26PP	131	3253CL	31	400STP	205	5FBRTT	142
2700 (Group 1)	26	3253CT	32	40CWC	125	5UBR	142
2700 (Group 3)	26	32CC	61	40CWCH	125	60CFC	132
2700CT	32	32CW	123	40CWCHN	125	60CW	51
28CW	123	32HP	127	40CWD	123	60CWC	125
28PP	131	3343 (Group 1)	27	40HPC	129	60CWCH	125
2900CT	32	3343 (Group 3)	27	40HPCH	129	60CWCHN	125
2SFSCW	112	33CLRCW	124	40HPCHN	129	60CWD	123
2SFSP	113	33CLRHP	128	40HPD	127	60CWGL	125
2SFSP	113	34CW	123	40PPCH	131	60CWGL	129
300DIV	166	34HP	127	40PPD	131	60CWL	125
300DIV	168	34PP	131	40PPSC	131	60CWLN	125
300DIV	173	350LCD	163	40SC	125	60HPC	129
300MPC	168	35CLRCW	124	40SC	129	60HPCH	129
3046 (Group 1)	27	35CLRHP	128	415CBP	200	60HPCHN	129
3046 (Group 3)	27	35CW	51	42CW	123	60HPD	127
30CFC	132	36CF	132	42HP	127	60HPL	129
30CWC	125	36CW	123	44CW	123	60HPLN	129

Alpha Numerical Listing

PRODUCT CODE NUMBER	PAGE	PRODUCT CODE NUMBER	PAGE	PRODUCT CODE NUMBER	PAGE	PRODUCT CODE NUMBER	PAGE
60PPCH	131	850CW	62	9113CW	45	9S638	212
60PPCHN	131	853FCP	46	9114CP	45	9S800	212
60PPD	131	853FCPC	46	9114CW	45	9S958	212
60PPSC	131	853FCW	46	911CPC	45	9TGS	74
60SC	125	853FCWC	46	911CWC	45	ADCS	207
60SC	129	853FH	46	911VS	52	BAR540	157
62CW	123	853FHC	46	912CBP	200	BAR540DS	157
62HP	127	85SFVS	52	913MT	47	BAR54SR	153
6302MT	47	86VS	52	913VS	52	BAR650	157
630MT	47	8F	70	915 (Group 1)	25	BAR650CP	157
63CLRCW	124	8FB434	218	915 (Group 3)	25	BAR650DS	157
63CLRHP	128	8FBNH434	218	915CP	43	BAR650DSCP	157
64CW	123	8HC258	216	915CW	43	BAR650SDX	156
64HP	127	8HC258	221	918MT	47	BAR650SPM	156
64PP	131	8HC414	216	91VS	52	BAR650SPMT	156
650BIBR	153	8HE1	222	926 (Group 1)	25	BAR650SPMT2	156
650WS	153	8HE2	222	926 (Group 3)	25	BAR650DX	156
65CLRCW	124	8HS1114	215	92615MT	47	BAR650PM	156
65CLRHP	128	8HS318	215	926MT	47	BAR650PMT	156
65CWNR	51	8HS434	215	92CW	123	BAR650PMT220	156
66CF	132	8HS638	215	92HP	127	BAR730	155
66CW	123	8HS800	215	93CW	51	BAR730CP	155
66HP	127	8HS958	215	94CW	123	BAR730DS	155
66PP	131	8RS8	150	94HP	127	BAR730DSCP	155
68VS	52	8SFSCW	112	94PP	131	BAR730SDX	154
6F	70	8SFSP	113	950CW	62	BAR730DSM	154
6FBRTT	142	8SFSP	113	950P	61	BAR730DSPMT	154
6RS6	150	900 (Group 1)	26	950P2	61	BAR730DSPMT2	154
6SFSCW	112	900 (Group 3)	26	95VS	52	BAR730DX	154
6SFSP	113	900CT	32	96CW	51	BAR730PM	154
6SFSP	113	900CW	53	96SKRC	75	BAR730PMT	154
6TGS	74	900P	61	96SKRD	75	BAR730PMT220	154
6UBR	142	900P2	61	96SKRF	75	BBR480	142
725CWNR	51	9011CW	53	96SKRLC	75	BBR720	142
730BIBR	153	9013CW	53	96SKRLD	75	BC1115SH	202
730SR	153	901CW	53	96SKRLF	75	BC11TC	202
730STP	149	905CW	53	96SKRLM	75	BC225	202
730WS	153	909CW	53	96SKRLP	75	BC2254S	202
75CW	51	90CWC	125	96SKRM	75	BC230	202
800CW	62	90CWCN	125	96SKRP	75	BC2304S	202
800P	61	90CWD	123	978SFVS	52	BC235	202
800P2	61	90HPC	129	99SMVS	52	BC2354S	202
806CW	53	90HPD	127	99VS	52	BC330	202
810 (Group 1)	25	90PPC	131	9CWNR	51	BC3304S	202
810 (Group 3)	25	90PPD	131	9E1	221	BC331KD	201
825CWNR	51	90PPSC	131	9E2	222	BC331KDSH	201
8262MT	47	90SC	125	9RS9	150	BC331KDTC	201
826MT	47	90SC	129	9S1114	212	BC340KD	201
8302MT	47	90SPCW	51	9S318	212	BC340KDP	201
830MT	47	9113CP	45	9S434	212	BCT1014	42

Alpha Numerical Listing

PRODUCT CODE NUMBER	PAGE	PRODUCT CODE NUMBER	PAGE	PRODUCT CODE NUMBER	PAGE	PRODUCT CODE NUMBER	PAGE
BK60406	179	CD100	204	CLNT12	189	CP1220	149
BK60407	179	CD100H	204	CLNT20	58	CP1220	166
BR258	217	CD100HB	204	CLNT20	189	CP1220	168
BR258	221	CD1313	205	CLNT5	58	CP1220	171
BR414	217	CD1327	205	CLNT5	189	CP1220	173
BR578	188	CD1420	205	CLNT8	58	CP1220	184
BR578	217	CD160	204	CLNT8	189	CP15	72
BR712	217	CD1826H	203	CLRSB16	188	CP27	72
BSB10	70	CD1826HB	203	CLRSB9	188	CP6040	179
BSB12	70	CD1826MTC	183	CLRSM8B5	188	CP814	146
BSB18	70	CD1826MTC	204	CLRWSR36	188	CP814	166
BUF48	142	CD1826MTCHB	183	CLSB16	189	CPB1220	143
BUF72	142	CD1826MTCHB	204	CLSB9	189	CPH3	143
BV6CW	64	CD1826PDB	203	CLSM8B5	189	CPL12	69
BWB16CW	52	CD2020	203	CLSRB5	63	CPL27	69
BWM10CW	56	CD2020H	203	CLSRB5	189	CR12	206
BWP14CW	56	CD2020HB	203	CLSSM8B5	189	CRP122327	223
BWW10CW	56	CD2028	205	CMB1826	179	CRP122328	223
CA1300	37	CD300	168	CMB1826L	179	CRP12910	219
CA1623	36	CD300	204	CMB1826LSP	179	CRP12911	219
CA2026	36	CD300H	204	CMB1826SP	179	CRP141012	219
CA2028	37	CD300HB	204	CMBH1826LC	181	CRP142732	223
CA2129	36	CD400	168	CMBH1826LF	181	CRP181112	219
CA2632	37	CD400	171	CMBH1826LTR	181	CRP182832	223
CA2738	37	CD400	177	CMBH1826TBC	181	CRP191011	219
CA2836	37	CD400	204	CMBH1826TBF	181	CRP192528	223
CA3200	37	CDR2020	203	CMBH1826TSC	181	CRP201015	223
CA3244	37	CDR2020	220	CMBH1826TSF	181	CRP202326	223
CA3247TR	37	CDR2020H	203	CMBH1826TTR	181	CRP2046	219
CA3253	37	CDR2020H	220	CMBHC1826LC	181	CRP20910	219
CA3343	37	CFPFRC10	132	CMBHC1826LF	181	CRP281822	223
CA3446	37	CFPMRC10	132	CMBHC1826LTR	181	CRP2878	219
CA3646	37	CFPSRC10	132	CMBHC1826TBC	181	CRP301519	223
CA3748	37	CFR18	132	CMBHC1826TBF	181	CRP3067	219
CA3753	37	CFRC18	132	CMBHC1826TSC	181	CRP441518	223
CA3800	37	CFRSC18	132	CMBHC1826TSF	181	CRP4467	219
CA3952	37	CJ80CW	75	CMBHC1826TTR	181	CRP481315	223
CA4064H	36	CL900P	58	CMBR	181	CRP4856	219
CA4300	37	CL900P	189	C02632	35	CRP631013	223
CA4361	37	CL950P	58	C03200	35	CRP6345	219
CB1220	146	CL950P	189	C03253	35	CRP92328	223
CB1220	147	CLLT10	58	C03343	35	CRP9911	219
CB1220	149	CLLT10	189	C03646	35	CRPG12910	223
CB1220	181	CLLT12	58	C03753	35	CRPG12911	223
CC32	135	CLLT12	189	C03800	35	CRPG141012	223
CCP12	72	CLLT6	58	C04300	35	CRPG181112	223
CCP15	72	CLLT6	189	CP12	72	CRPG191011	223
CCP27	72	CLNT10	58	CP1210	132	CRPG2046	223
CCPL12	72	CLNT10	189	CP1210	166	CRPG20910	223
CCPL27	72	CLNT12	58	CP1220	146	CRPG2878	223

Alpha Numerical Listing

PRODUCT CODE NUMBER	PAGE	PRODUCT CODE NUMBER	PAGE	PRODUCT CODE NUMBER	PAGE	PRODUCT CODE NUMBER	PAGE
CRPG3067	223	CS2148SK	84	CSA48546	85	CSDS21	87
CRPG4467	223	CS2148VK	84	CSA48547	85	CSDS24	87
CRPG4856	223	CS2154SK	84	CSA48606	85	CSEQ3	85,87
CRPG6345	223	CS2154VK	84	CSA48607	85	CSEQ3	97
CRPG9911	223	CS2160SK	84	CSA51366	86	CSFE14	88
CRPH161317	223	CS2160VK	84	CSA51367	86	CSFE18	88
CRPH1656	219	CS2172SK	84	CSA51426	86	CSFE21	88
CRPHDG2878	217	CS2172VK	84	CSA51427	86	CSFE24	88
CRPHDG2878	203	CS2424SK	84	CSA51486	86	CSFT241	88
CRPHG1656	223	CS2424VK	84	CSA51487	86	CSFT242	88
CS1424SK	84	CS2430SK	84	CSA51546	86	CSFT301	88
CS1424VK	84	CS2430VK	84	CSA51547	86	CSFT302	88
CS1430SK	84	CS2436SK	84	CSA51606	86	CSFT361	88
CS1430VK	84	CS2436VK	84	CSA51607	86	CSFT362	88
CS1436SK	84	CS2442SK	84	CSA54366	86	CSFT421	88
CS1436VK	84	CS2442VK	84	CSA54367	86	CSFT422	88
CS1442SK	84	CS2448SK	84	CSA54368PKG	87	CSFT481	88
CS1442VK	84	CS2448VK	84	CSA54426	86	CSFT482	88
CS1448SK	84	CS2454SK	84	CSA54427	86	CSFT541	88
CS1448VK	84	CS2454VK	84	CSA54428PKG	87	CSFT542	88
CS1454SK	84	CS2460SK	84	CSA54486	86	CSFT601	88
CS1454VK	84	CS2460VK	84	CSA54487	86	CSFT602	88
CS1460SK	84	CS2472SK	84	CSA54488PKG	87	CSFT721	88
CS1460VK	84	CS2472VK	84	CSA54546	86	CSFT722	88
CS1472SK	84	CSA41366	86	CSA54547	86	CSHDC	91
CS1472VK	84	CSA41367	86	CSA54548PKG	87	CSHDDB	91
CS1824SK	84	CSA41426	86	CSA54606	86	CSHDDB	91
CS1824VK	84	CSA41427	86	CSA54607	86	CSHDTK10	91
CS1830SK	84	CSA41486	86	CSA54608PKG	87	CSHDTK12	91
CS1830VK	84	CSA41487	86	CSA58366	85	CSHDTK145	91
CS1836SK	84	CSA41546	86	CSA58367	85	CSID	85,87
CS1836VK	84	CSA41547	86	CSA58426	85	CSID	97
CS1842SK	84	CSA41606	86	CSA58427	85	CSID3	85,87
CS1842VK	84	CSA41607	86	CSA58486	85	CSID3	97
CS1848SK	84	CSA44366	86	CSA58487	85	CSPK1432	84
CS1848VK	84	CSA44367	86	CSA58546	85	CSPK1456	84
CS1854SK	84	CSA44426	86	CSA58547	85	CSPK1464	84
CS1854VK	84	CSA44427	86	CSA58606	85	CSPK1472	83
CS1860SK	84	CSA44486	86	CSA58607	85	CSPK1484	84
CS1860VK	84	CSA44487	86	CSCC	87	CSPK1832	84
CS1872SK	84	CSA44546	86	CSCR	88	CSPK1856	84
CS1872VK	84	CSA44547	86	CSCS	88	CSPK1864	84
CS2124SK	84	CSA44606	86	CSCSL	88	CSPK1872	83
CS2124VK	84	CSA44607	86	CSCTL	88	CSPK1884	84
CS2130SK	84	CSA48366	85	CSDBA	92	CSPK2132	84
CS2130VK	84	CSA48367	85	CSDBS	92	CSPK2156	84
CS2136SK	84	CSA48426	85	CSDC	188	CSPK2164	84
CS2136VK	84	CSA48427	85	CSDDCPKG480	188	CSPK2172	83
CS2142SK	84	CSA48486	85	CSDS14	87	CSPK2184	84
CS2142VK	84	CSA48487	85	CSDS18	87	CSPK2432	84

Alpha Numerical Listing

PRODUCT CODE NUMBER	PAGE	PRODUCT CODE NUMBER	PAGE	PRODUCT CODE NUMBER	PAGE	PRODUCT CODE NUMBER	PAGE
CSPK2456	84	CSU48606	85	CSUR41487	89	CSURS51367	89
CSPK2464	84	CSU48607	85	CSUR44366	89	CSURS51426	89
CSPK2472	83	CSU51366	85	CSUR44367	89	CSURS51427	89
CSPK2484	84	CSU51367	85	CSUR44426	89	CSURS51486	89
CSPRK1835	88	CSU51426	85	CSUR44427	89	CSURS51487	89
CSPRK1859	88	CSU51427	85	CSUR44486	89	CSURS54366	89
CSPRK1867	88	CSU51486	85	CSUR44487	89	CSURS54367	89
CSPRK1875	88	CSU51487	85	CSUR48366	89	CSURS54426	89
CSPRK2135	88	CSU51546	85	CSUR48367	89	CSURS54427	89
CSPRK2159	88	CSU51547	85	CSUR48426	89	CSURS54486	89
CSPRK2167	88	CSU51606	85	CSUR48427	89	CSURS54487	89
CSPRK2175	88	CSU51607	85	CSUR48486	89	CSURS58366	89
CSPRK2435	88	CSU54366	86	CSUR48487	89	CSURS58367	89
CSPRK2459	88	CSU54367	86	CSUR51366	89	CSURS58426	89
CSPRK2467	88	CSU54368PKG	87	CSUR51367	89	CSURS58427	89
CSPRK2475	88	CSU54426	86	CSUR51426	89	CSURS58486	89
CSR3	160	CSU54427	86	CSUR51427	89	CSURS58487	89
CSR5	160	CSU54428PKG	87	CSUR51486	89	CSWF	85,87
CSRDB	88	CSU54486	86	CSUR51487	89	CSWF	97
CSSB	88	CSU54487	86	CSUR54366	89	CSWS1436SK	105
CSSC2448	92	CSU54488PKG	87	CSUR54367	89	CSWS1436VK	105
CSTSR	92	CSU54546	86	CSUR54426	89	CSWS1448SK	105
CSU41366	85	CSU54547	86	CSUR54427	89	CSWS1448VK	105
CSU41367	85	CSU54548PKG	87	CSUR54486	89	CSWS1836SK	105
CSU41426	85	CSU54606	86	CSUR54487	89	CSWS1848SK	105
CSU41427	85	CSU54607	86	CSUR58366	89	CSWS36EK	105
CSU41486	85	CSU54608PKG	87	CSUR58367	89	CSWS48EK	105
CSU41487	85	CSU58366	85	CSUR58426	89	CVC55	148
CSU41546	85	CSU58367	85	CSUR58427	89	CVC72	148
CSU41547	85	CSU58426	85	CSUR58486	89	CVC724	148
CSU41606	85	CSU58427	85	CSUR58487	89	D12	60
CSU41607	85	CSU58486	85	CSURS41366	89	D14	60
CSU44366	86	CSU58487	85	CSURS41367	89	D16	60
CSU44367	86	CSU58546	85	CSURS41426	89	D24	60
CSU44426	86	CSU58547	85	CSURS41427	89	D8	60
CSU44427	86	CSU58606	85	CSURS41486	89	DB18263CW	134
CSU44486	86	CSU58607	85	CSURS41487	89	DB18263P	134
CSU44487	86	CSUHD44367	91	CSURS44366	89	DB18266CW	134
CSU44546	86	CSUHD44367S	91	CSURS44367	89	DBC1826CW	134
CSU44547	86	CSUHD44427	91	CSURS44426	89	DBC1826P	134
CSU44606	86	CSUHD44427S	91	CSURS44427	89	DC10	66
CSU44607	86	CSUHD44486	91	CSURS44486	89	DC1225	209
CSU48366	85	CSUHD44486S	91	CSURS44487	89	DC5	66
CSU48367	85	CSUHD44487	91	CSURS48366	89	DC575	209
CSU48426	85	CSUHD44487S	91	CSURS48367	89	DC700	209
CSU48427	85	CSUR41366	89	CSURS48426	89	DC825	209
CSU48486	85	CSUR41367	89	CSURS48427	89	DCC10	66
CSU48487	85	CSUR41426	89	CSURS48486	89	DCC5	66
CSU48546	85	CSUR41427	89	CSURS48487	89	DCS1125	209
CSU48547	85	CSUR41486	89	CSURS51366	89	DCS950	209

Alpha Numerical Listing

PRODUCT CODE NUMBER	PAGE	PRODUCT CODE NUMBER	PAGE	PRODUCT CODE NUMBER	PAGE	PRODUCT CODE NUMBER	PAGE
DD1220BECW	71	EA244272	101	EMSK2154V	102	EPK1472	97
DD1220CW	71	EA244284PKG	101	EMSK2160S	102	EPK1484	97
DD1220ECW	71	EA244864	101	EMSK2160V	102	EPK1864	97
DD1220SCW	71	EA244872	101	EMSK2436S	102	EPK1872	97
DD1826CW	71	EA244884PKG	101	EMSK2436V	102	EPK1884	97
DG3CW	56	EA245464	101	EMSK2442S	102	EPK2164	97
DIV12	143	EA245472	101	EMSK2442V	102	EPK2172	97
DIV12	149	EA245484PKG	101	EMSK2448S	102	EPK2184	97
DIV12	165	EA246064	101	EMSK2448V	102	EPK2464	97
DIV20	143	EA246072	101	EMSK2454S	102	EPK2472	97
DIV20	165	EA246084PKG	101	EMSK2454V	102	EPK2484	97
DP15	66	ECC	97	EMSK2460S	102	ES28	147
DRC2020	188	EDBA	104	EMSK2460V	102	ES28RL	147
DRC2020	220	EDBS	104	EMU183670	103	ESK1430S	97
DRLNK	106	EDS14	97	EMU183670P	103	ESK1430V	97
DRS30	106	EDS18	97	EMU183678	103	ESK1436S	97
DRS300	106	EDS21	97	EMU183678P	103	ESK1436V	97
DRS36	106	EDS24	97	EMU184270	103	ESK1442S	97
DRS360	106	EHDC	Discontinued 1/1/12	EMU184270P	103	ESK1442V	97
DRS48	106	EHDU184878S	Discontinued 1/1/12	EMU184278	103	ESK1448S	97
DRS480	106	EHDU184878V	Discontinued 1/1/12	EMU184278P	103	ESK1448V	97
DRS60	106	EHDU244878S	Discontinued 1/1/12	EMU184870	103	ESK1454S	97
DRS600	106	EHDU244878V	Discontinued 1/1/12	EMU184870P	103	ESK1454V	97
DSPR6	63	EMPK1870	102	EMU184878	103	ESK1460S	97
DT1220CW	71	EMPK1878	102	EMU184878P	103	ESK1460V	97
E3	222	EMPK2170	102	EMU213670	10	ESK1472S	97
EA183664	101	EMPK2178	102	EMU213670P	103	ESK1472V	97
EA183672	101	EMPK2470	102	EMU213678	103	ESK1478S	97
EA184264	101	EMPK2478	102	EMU213678P	103	ESK1478V	97
EA184272	101	EMSC	104	EMU214270	103	ESK1830S	97
EA184864	101	EMSCB	104	EMU214270P	103	ESK1830V	97
EA184872	101	EMSCBP	104	EMU214278	103	ESK1836S	97
EA185464	101	EMSCP	104	EMU214278P	103	ESK1836V	97
EA185472	101	EMSK1836S	102	EMU214870	103	ESK1836V4	97
EA186064	101	EMSK1836V	102	EMU214870P	103	ESK1842S	97
EA186072	101	EMSK1842S	102	EMU214878	103	ESK1842V	97
EA213664	101	EMSK1842V	102	EMU214878P	103	ESK1848S	97
EA213672	101	EMSK1848S	102	EMU243670	103	ESK1848V	97
EA214264	101	EMSK1848V	102	EMU243670P	103	ESK1848V4	97
EA214272	101	EMSK1854S	102	EMU243678	103	ESK1854S	97
EA214864	101	EMSK1854V	102	EMU243678P	103	ESK1854V	97
EA214872	101	EMSK1860S	102	EMU244270	103	ESK1860S	97
EA215464	101	EMSK1860V	102	EMU244270P	103	ESK1860V	97
EA215472	101	EMSK2136S	102	EMU244278	103	ESK1860V4	97
EA216064	101	EMSK2136V	102	EMU244278P	103	ESK1872S	97
EA216072	101	EMSK2142S	102	EMU244870	103	ESK1872V	97
EA243664	101	EMSK2142V	102	EMU244870P	103	ESK1878S	97
EA243672	101	EMSK2148S	102	EMU244878	103	ESK1878V	97
EA243684PKG	101	EMSK2148V	102	EMU244878P	103	ESK2130S	97
EA244264	101	EMSK2154S	102	EPK1464	97	ESK2130V	97

Alpha Numerical Listing

PRODUCT CODE NUMBER	PAGE	PRODUCT CODE NUMBER	PAGE	PRODUCT CODE NUMBER	PAGE	PRODUCT CODE NUMBER	PAGE
ESK2136S	97	ESU215472	100	GP0540NS (Group 3)	20	HT5CW	59
ESK2136V	97	ESU216064	100	GP0540NS (Group 3)	191	HT8CW	59
ESK2142S	97	ESU216072	100	GP1070 (Group 1)	17	HWAPR	160
ESK2142V	97	ESU243664	100	GP1070AB (Group 1)	18	HWATD	160
ESK2148S	97	ESU243672	100	GP1070AB (Group 1)	190	IB32	135
ESK2148V	97	ESU243684PKG	100	GP1080 (Group 1)	17	IB36	135
ESK2154S	97	ESU244264	100	GP1080AB (Group 1)	18	IB44	135
ESK2154V	97	ESU244272	100	GP1080AB (Group 1)	190	IBS20	135
ESK2160S	97	ESU244284PKG	100	GP1080NS (Group 3)	20	IBS27	135
ESK2160V	97	ESU244864	100	GP1080NS (Group 3)	191	IBS37	135
ESK2172S	97	ESU244872	100	GP3074 (Group 1)	17	IBSF27	135
ESK2172V	97	ESU244884PKG	100	GP3980 (Group 1)	19	ICS100L	158
ESK2178S	97	ESU245464	100	GP3980 (Group 3)	16	ICS100L4S	158
ESK2178V	97	ESU245472	100	GP3980AB (Group 1)	18	ICS125L	158
ESK2430S	97	ESU245484PKG	100	GP3980AB (Group 1)	190	ICS125LB	158
ESK2430V	97	ESU246064	100	GP3980NS (Group 3)	20	ICS125T	158
ESK2436S	97	ESU246072	100	GP3980NS (Group 3)	191	ICS175L	158
ESK2436V	97	ESU246084PKG	100	GP4002 (Group 1)	19	ICS175LB	158
ESK2436V4	97	FBR5R	143	GP4002 (Group 3)	16	ICS175T	158
ESK2442S	97	FBR6R	143	GP4002AB (Group 1)	18	ICS175TB	158
ESK2442V	97	FBRTBL	143	GP4002AB (Group 1)	190	ICS200TB	158
ESK2448S	97	FPID24	130	GP4002NS (Group 3)	20	IT3253	48
ESK2448V	97	FR258	218	GP4002NS (Group 3)	191	IT3253	195
ESK2448V4	97	FSG480	142	GP4004 (Group 1)	19	IT3753	48
ESK2454S	97	FSG720	142	GP4004 (Group 3)	16	IT3753	195
ESK2454V	97	FWC56	206	GP4210 (Group 1)	17	ITPD3253	48
ESK2460S	97	FWC56	218	GP4701 (Group 1)	17	ITPD3253	195
ESK2460V	97	GB1200CW	56	GP4709 (Group 1)	17	ITPD3753	48
ESK2460V4	97	GB850CW	56	GP4853 (Group 1)	17	ITPD3753	195
ESK2472S	97	GK2000	216	GP4856 (Group 1)	17	KK1200	216
ESK2472V	97	GL0540 (Group 1)	22	GP55653 (Group 1)	17	KMC24	146
ESK2478S	97	GL1070 (Group 1)	22	GP55702 (Group 1)	17	KSC402	147
ESK2478V	97	GL1070RNS	24	GP55703 (Group 1)	17	KSC402220	147
ESU183664	100	GL1080 (Group 1)	22	HBR258	217	KVC854	146
ESU183672	100	GL210P (Group 1)	23	HBR258	221	KVC854C	146
ESU184264	100	GL220P (Group 1)	23	HBR414	217	KVC854U	146
ESU184272	100	GL3074 (Group 1)	22	HBR578	217	KVC856	146
ESU184864	100	GL3980 (Group 1)	22	HBR712	217	KVC856C	146
ESU184872	100	GL3980NS (Group 1)	21	HE3	222	KVC856U	146
ESU185464	100	GL3980RNS	24	HFR258	218	KWS40	147
ESU185472	100	GL4002 (Group 1)	22	HK39	51	LCDCH	163
ESU186064	100	GL4002NS (Group 1)	21	HK39B	187	LCDCH10	163
ESU186072	100	GL4002RNS	24	HK93BCW	51	LCDES	160
ESU213664	100	GL4060	179	HK93CW	51	LCDES	163
ESU213672	100	GL4060 (Group 1)	22	HT10CW	59	LD105	72
ESU214264	100	GL4210 (Group 1)	22	HT120CW	59	LD105A	72
ESU214272	100	GL4701 (Group 1)	22	HT12CW	59	LD130	72
ESU214864	100	GL4709 (Group 1)	22	HT14CW	59	LD130A	72
ESU214872	100	GP0540 (Group 1)	19	HT16CW	59	LD85	72
ESU215464	100	GP0540 (Group 3)	16	HT22CW	59	LD85A	72

Alpha Numerical Listing

PRODUCT CODE NUMBER	PAGE	PRODUCT CODE NUMBER	PAGE	PRODUCT CODE NUMBER	PAGE	PRODUCT CODE NUMBER	PAGE
LED54LIGHTPKG	143	MY3253	38	PH558526	33	RFS4PP	117
LT10	60	MY3343	38	PH558530	33	RFS6	117
LT12	60	MY3446	38	PH558536	33	RFS6PP	117
LT14	60	MY3646	38	PL60CW	55	RFS6SCPP	116
LT16	60	MY3753	38	PPB15	64	RFS8	117
LT22	60	MY3800	38	PPB18	64	RFS8PP	117
LT6	60	MY3952	38	PPB23	64	RFSC1	117
LT8	60	MY4300	38	PR314	218	RFSC12	63
MA2435	39	MY4361	38	PR500	218	RFSC12	117
MA3142H	39	NT10	59	PR59314	218	RFSC12PP	117
MA3200	39	NT12	59	PR59500	218	RFSC1PP	117
MA3343	39	NT14	59	PS1014	42	RFSC2	117
MA3646	39	NT16	59	PSB10	68	RFSC2PP	117
MA3652TR	39	NT20	59	PSB12	68	RFSC6	117
MA3800	39	NT5	59	PSB15	69	RFSC6PP	117
MA4300	39	NT8	59	PSB18	69	RFSCW1	116
MA4361	39	NT9	59	PSB23	69	RFSCW12	116
MDC1411T60	198	OETR314	218	PSB6	68	RFSCW18	116
MDC1418S20	196	P320CW	55	PSB8	68	RFSCW2	116
MDC1418T16	197	P480CW	55	PT1014	41	RFSCW22	116
MDC1418T30	197	P600CW	55	PT1100	41	RFSCW4	116
MDC1520S20	196	P60CW	55	PT1216	41	RFSCW6	116
MDC1520T16	197	P64CW	55	PT1400	41	RFSCW8	116
MDC1520T30	197	PC64CW	55	PT1418	41	RFSCWC1	116
MDC24	184	PE600CW	55	PT1600	41	RFSCWC12	116
MDC24F	184	PH556010	33	PWB22	63	RFSCWC2	116
MDC24R	184	PH556016	33	PWB22	160	RFSCWC6	116
MDSB16	187	PH556020	33	R1000LCD	163	RSB1014CW	69
MDSB5	187	PH556026	33	R500LCD	160	RSB10CW	69
MDSB9	187	PH556030	33	R500LCD	163	RSB12CW	69
MDSD9	187	PH556036	33	RD1200CW	71	RSB1419CW	69
MDSL9	173	PH556040	33	RD1220CW	71	RSB15CW	69
MDSL9	187	PH556046	33	RD1220CWH	71	RSB18CW	69
MDSM8	187	PH556050	33	RD1826CW	71	RSB23CW	69
MDSP9	173	PH556056	33	RD1826CWH	71	RSB6CW	69
MDSPL	187	PH556510	33	RD926CW	71	RSB8CW	69
MDSPLT9	187	PH556516	33	RFS1	117	RSB912CW	69
MW2129	34	PH556520	33	RFS12	117	SB55	70
MW3200	34	PH556526	33	RFS12PP	117	SB60	70
MW3245	34	PH557010	33	RFS12SCPP	116	SB80	70
MW3600	34	PH557016	33	RFS18	117	SBH15	143
MW3646	34	PH557020	33	RFS18PP	117	SBH18	143
MW3858	34	PH557026	33	RFS1PP	117	SCP12CW	136
MW4200	34	PH557030	33	RFS1SCPP	116	SCP24CW	136
MY2026	38	PH557036	33	RFS2	117	SCP64CW	136
MY2129	38	PH557040	33	RFS22	117	SCP6CW	136
MY2632	38	PH557046	33	RFS22PP	117	SFC12	113
MY2738	38	PH558510	33	RFS2PP	117	SFC12SCPP	11
MY3200	38	PH558516	33	RFS2SCPP	116	SFC2	113
MY3244	38	PH558520	33	RFS4	117	SFC2SCPP	112

Alpha Numerical Listing

PRODUCT CODE NUMBER	PAGE	PRODUCT CODE NUMBER	PAGE	PRODUCT CODE NUMBER	PAGE	PRODUCT CODE NUMBER	PAGE
SFC6	113	UPC1600	173	VBRL6	140	VT3343 (Group 1)	16
SFC6SCPP	112	UPC1600HD	173	VBRLHD5	140	VT3343AB (Group 1)	18
SFG1012	67	UPC1600TR	173	VBRLHD6	140	VT3343AB (Group 1)	190
SFG1015	67	UPC180	165	VBRR5	143	VT3343C (Group 1)	16
SFG1220	67	UPC400	168	VBRR6	143	VT3343CAB (Group 1)	18
SFG820	67	UPC400TR	168	VBRSHTS	143	VT3343CAB (Group 1)	190
SFR1012	67	UPC600	173	VBRT5	140	VT3646C (Group 1)	16
SFT1010	67	UPC800	173	VBRT6	140	VT3646CAB (Group 1)	18
SFT1212	67	UPC800TR	173	VBRTBL	143	VT3646CAB (Group 1)	190
SFT1515	67	UPCH1600	177	VBRTCVR5	143	VT3753 (Group 1)	16
SFV1015	67	UPCH16002	177	VBRTCVR6	143	VT3853 (Group 1)	16
SLL30	133	UPCH16002HD	177	VBRTHD5	140	WC100CW	64
SPA14	73	UPCH1600HD	177	VBRTHD6	140	WC100CWNH	64
SPASL14	73	UPCH400	177	VBRTL5	140	WCR1220	146
SPO10CW	73	UPCH4002	177	VBRTL6	140	WCR1220	149
SPO11	73	UPCH800	177	VBRTLHD5	140	WCS30	64
SPO11CW	73	UPCH8002	177	VBRTLHD6	140	WR60406	179
SPO13	73	UPCHBD1600	177	VBRWC	143	WR60407	179
SPO13CW	73	UPCHBD16002	177	VCS	141	WW1000CW	62
SPO8CW	73	UPCHBD800	177	VCS32CNT	141	WW1000L	62
SPOP10CW	73	UPCHBD8002	177	VCS32KEYT	143	WW1000LS	62
SPOP11	73	UPCHD400	177	VCS32R	143	WW1500CW	62
SPOP11CW	73	UPCHD4002	177	VCSCNL	141	WW250CW	62
SPOP13	73	UPCHT1600	177	VCSCVR	143	WW250L	62
SPOP13CW	73	UPCHT16002	177	VCSHD	141	WW500CW	62
SRB13	63	UPCHT16002HD	177	VCSWR	141		
SRB13CW	63	UPCHT1600HD	177	VCSWRHD	141		
SRB5	63	UPCHT800	177	VL1014 (Group 1)	23		
SRB5CW	63	UPCHT8002	177	VL1216 (Group 1)	23		
TC1418	206	UPCHTD1600	177	VL1418 (Group 1)	23		
TDC2029	206	UPCHTD16002	177	VL1418NS (Group 1)	21		
TDC30	209	UPCHTD800	177	VL1418RNS	24		
TDCR12	206	UPCHTD8002	177	VL2129RNS	24		
TG6	74	UPCHW400	177	VL2632 (Group 1)	23		
TG9	74	UPCHW4002	177	VL3200RNS	24		
TGA11	74	UPCS140	165	VL3253 (Group 1)	23		
TGA8	74	UPCS160	165	VL3343 (Group 1)	23		
TGG6	74	UPCS180	165	VL3343C (Group 1)	23		
TGG9	74	UPCS400	171	VL3343CNS (Group 1)	21		
UC1000	163	UPCS400CK	171	VL3343NS (Group 1)	21		
UC1000CVR	163	UPCSS160	165	VL3600RNS	24		
UC250	163	VBR5	140	VL3646C (Group 1)	23		
UC250CVR	163	VBR6	140	VL3646CNS (Group 1)	21		
UC500	163	VBRC	141	VL3753 (Group 1)	23		
UC500CVR	163	VBRC90	141	VT1216 (Group 1)	16		
UPC100	165	VBRCVR5	143	VT1418 (Group 1)	16		
UPC101	165	VBRCVR6	143	VT1418AB (Group 1)	18		
UPC1200	173	VBRLHD5	140	VT1418AB (Group 1)	190		
UPC140	165	VBRLHD6	140	VT2632 (Group 1)	16		
UPC160	165	VBRL5	140	VT3253 (Group 1)	16		

Cambro® Equipment Color Chart

Cambro provides a wide selection of colors to help you coordinate with your decor and color code items to simplify use.

Color selections vary by product.

Please see individual products for specific colors offered.

Due to the printing process, the colors shown may not be exact.

For exact colors, contact Cambro or a Cambro Sales Representative for a color chip.



480
Speckled Gray



180
Gray



191
Granite Gray



159
Cold Blue

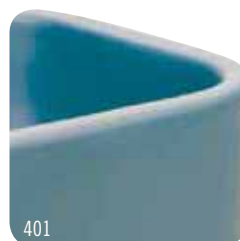

401
Slate Blue



186
Navy Blue



192
Granite Green



519
Kentucky Green



158
Hot Red



402
Brick Red



614
Sandstone



157
Coffee Beige



146
Bronze



417
Dark Taupe



194
Granite Sand



131
Dark Brown



110
Black

Due to the catalog printing process, the colors shown may not be exact. For exact colors, contact Cambro or a Cambro representative for a color chip.

For A Complete List of U.S.A. and International Representatives Please Visit www.cambro.com

New from CAMBRO®



Microban® Antibacterial
Camguard® Versa Trays
Page 18, 190



Non-Skid Versa Camtrays®
Page 21, 192



Versa Lite Trays
Low Profile Flat Edge Shape
Page 23



Non-Skid Room Service Vers Camtrays
Page 30, 193



Dessert Glass
Page 56



Camtainer® Cover
Page 162

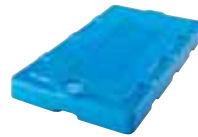

Camchiller®
Page 166



Low Profile Insulated Dome and
Heat Keeper Insulated base
Page 187



Entree Bowl and Reusable
Entree Bowl Lid
Page 187, 189



Camshelving® Elements Series
Page 93



20 and 30 Compartment Camracks®
Page 213

COMCATER
-foodservice equipment
www.comcater.com.au

NATIONAL HEAD OFFICE
156 Swann Drive, Derrimut, VIC 3030
Phone: 03 8369 4600
Fax: 03 8369 4699
Email: sales@comcater.com.au

NATIONAL CUSTOMER SERVICE
Phone: 1800 035 327
Fax: 1800 808 954



SCAN TO WIN
Enter to Win Cambro's
Monthly Product Giveaway!
*Scan this QR Code or visit
<http://www.cambro.com/win>
*Go to www.cambro.com/win
for complete contest details.

CAMBRO
TRUSTED FOR GENERATIONS™

CAMBRO U.S.A.
5801 Skylab Road, Huntington Beach, CA 92647
P.O. Box 2000, Huntington Beach, CA 92647-2000
TEL: (714) 848-1555 FAX: (714) 843-2630

© Copyright Cambro Manufacturing Company 2012. Printed in the U.S.A.
CAT2012METAUST

C.E.L.
TEL: (31) 168 707 210
FAX: (31) 168 707 211

NORTH IRELAND & UK
TEL: 0800 587 0057 Toll Free
FAX: 0845 280 3411
IRELAND
TEL: 1800 509 046 Toll Free
FAX: 01 633 55 76
cambroeuropa@cambro.com

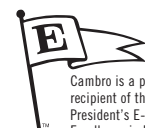

Cambro is a proud
recipient of the U.S.
President's E-Award for
Excellence in Exporting.