

Curved canopy offers greater visibility while maintaining hygiene

Fully populated with 5L Gastronorm pans and cross frame for quick setup (excluding GD0007S)

Dual temperature control for separate display and storage (excluding GD0007S)

High-impact lighting for perfect product presentation (excluding GD0007S)

Automatic defrost with heated internal walls and hot gas evaporation eliminates downtime (excluding GD0007S)



Castors make movement & placement easy

Additional internal storage for seamless tub interchange during service (excluding GD0007S)



Bromic's Gelato Display range presents a number of premium standalone storage and display solutions that are perfect for preserving frozen treats at their ideal serving and storage temperatures.

57. Chest Freezer Display

Bromic's Chest Freezer Gelato Display offers an entry-level unit with the versatility to operate as a chest freezer when not tempting customers with frozen treats.

Featuring a sliding glass lid, curved canopy and distinctive styling, this unit excels in attention-grabbing, front-of-house display.



57. Fenice Display

Bromic's Fenice Gelato Displays have been developed in conjunction with internationally-acclaimed manufacturer IARP to offer the ultimate standalone gelato display and storage solution.

With the ability to deep freeze desserts in storage before bringing them up to serving temperature on display, the FENICE range can be relied upon to perfectly preserve a range of frozen treats while presenting them proudly.



58. Specification Reference Guide



GN 1/3 pans (5L) included with Fenice units only

Gelato Displays



Tub Support Framework

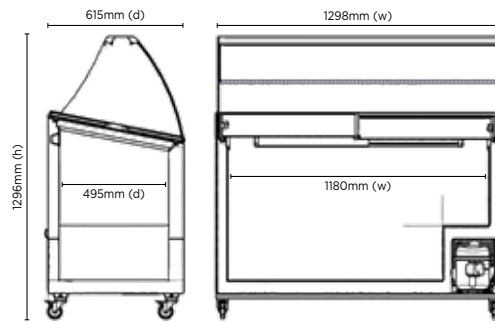
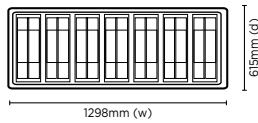

GD0007S

Chest Freezer Gelato Display

Part No.	Capacity	Weight
3735262	352L	81kg
	External (mm)	Internal (mm)
Width	1298	1180
Depth	615	495
Height	1296	708

- Tilted display with curved canopy offers great visibility while maintaining hygiene
- Sliding lid minimises energy consumption and keeps contents cool on display
- Included internal frame to accommodate baskets
- Temperature range: -22°C to -14°C
- Includes 7 plastic 5L tubs



Exposure Tank

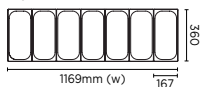

Storage Tank

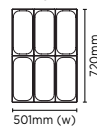

7 x stainless steel 5 litre tubs included

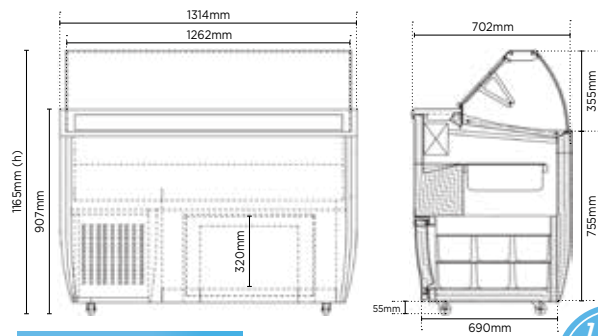

FENICE7

Fenice 7-Tub Gelato Display

Part No.	Capacity	Weight
3736205	381L	137kg
	External (mm)	Internal (mm)
Width	1314	1190
Depth	702	505
Height	1165	755

- Tilted display with curved canopy offers great visibility while maintaining hygiene
- Includes 7 stainless steel 5L tubs
- Rear storage areas hold 12 additional 5L tubs
- One digital temperature control inside the tank
- Temperature range: -25°C to -18°C



Exposure Tank

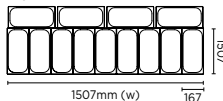

Storage Tank

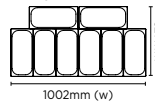

13 x stainless steel 5 litre tubs included

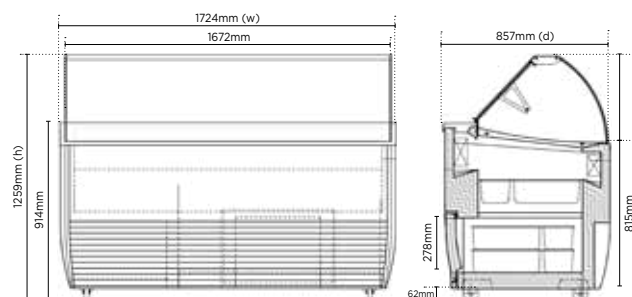

FENICE13

Fenice 13-Tub Gelato Display

Part No.	Capacity	Weight
3736215	496L	199kg
	External (mm)	Internal (mm)
Width	1724	1580
Depth	857	610
Height	1259	768

- Tilted display with curved canopy offers great visibility while maintaining hygiene
- Includes 13 stainless steel 5L tubs
- Rear storage areas hold 16 additional 5L tubs
- Dual temperature control inside storage compartment and inside display area allows easy serve of scoop icecream
- Temperature range: -25°C to -18°C



Gelato Displays

Specification Reference Guide

Model	GD0007S	FENICE7	FENICE13
Part Number	3735262	3736205	3736215
Ext. Width (mm)*	1298	1314	1724
Ext. Depth (mm)*	615	702	857
Ext. Height (mm)*	1296	1165	1259
Capacity	352L	381L	496L
Temp. Range	-22 to -14°C	-25 to -18°C	-25 to -18°C
Max. Ambient Temp.	35°C	35°C	35°C
Refrigeration Power	300W	800W	1050W
Current	2.3A	3.7A	5.4A
Gross Weight	81kg	137kg	199kg
Refrigerant	R404a	R507a	R507a
Plug Supplied	1	1	1
Power Supply	10A	10A	10A
Features			
Main Light	LED	Fluorescent	Fluorescent
Number of Lids	2	1	1
Lid Type	Sliding	Flip	Flip
Safety Glass Lid	✓		
Canopy	✓	✓	✓
Door Lock	✓		
No. of Baskets Incl.	3 (wire frame support tubs)		
No. of Tubs Incl.	7 (Plastic Tubs)	7 (Stainless Steel Tubs)	13 (Stainless Steel Tubs)
Automatic Defrosting System		✓	✓
Dual Temp. Controllers in Display Area & Storage			✓
No. of Tubs in Storage	7	12	16
Castors	✓	✓	✓
Colour	White	White	White
Warranty			
Parts (Years)	1	1	1
Labour (Years)	1	1	1

*Dimensions exclude handle protrusions