

CF0300ATCG | Angled Glass Top 264L Chest Freezer

Chest Freezers

CF0300ATCG

**ANGLED GLASS
TOP 264L CHEST
FREEZER**

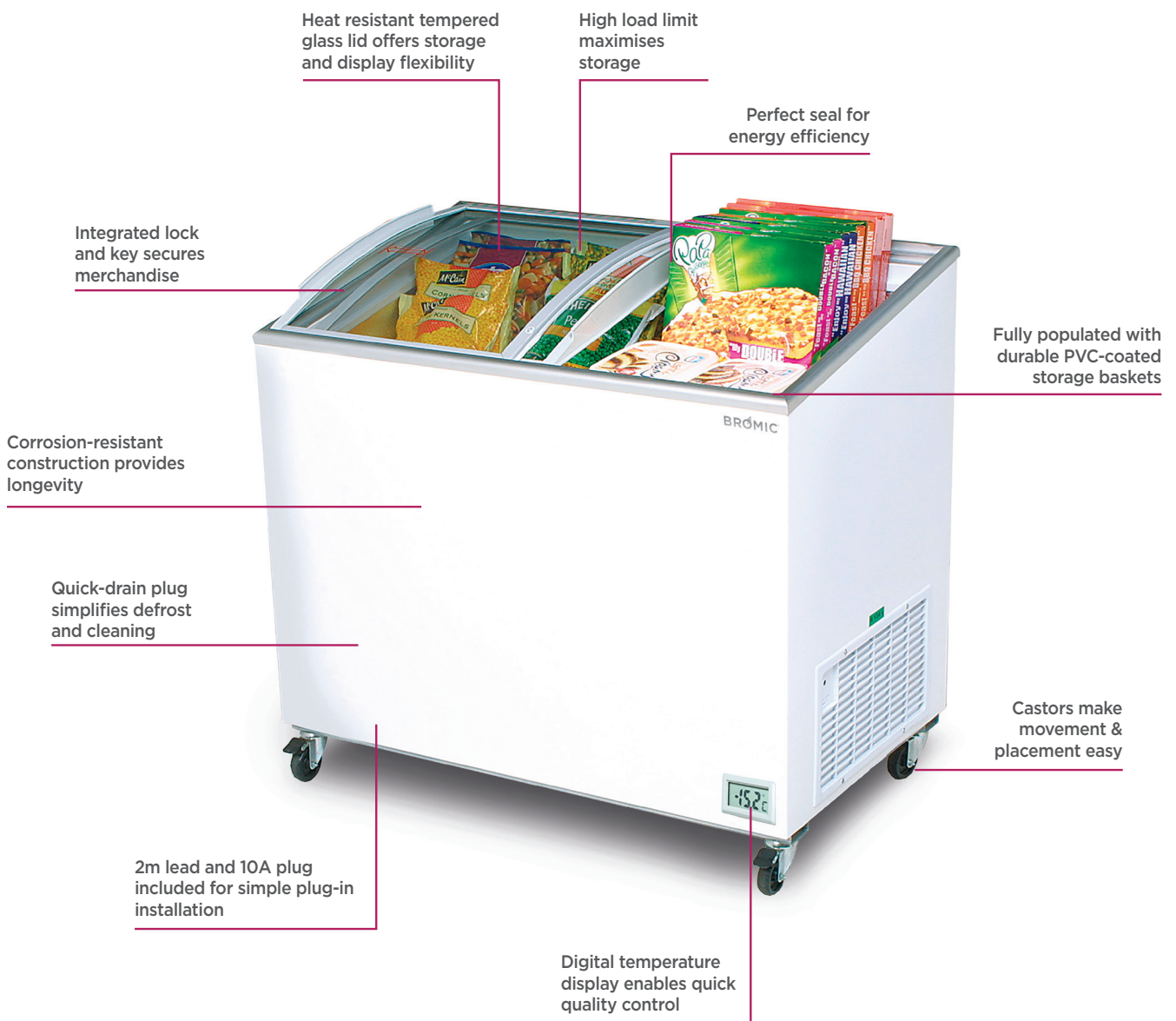

CF0300ATCG | Angled Glass Top 264L Chest Freezer

Chest Freezers

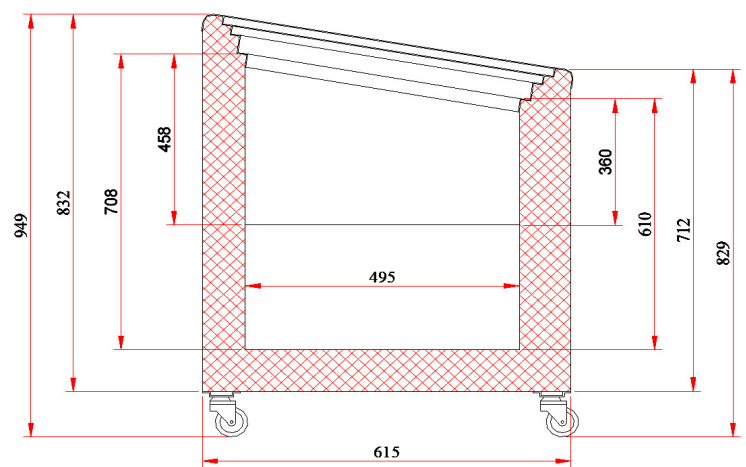
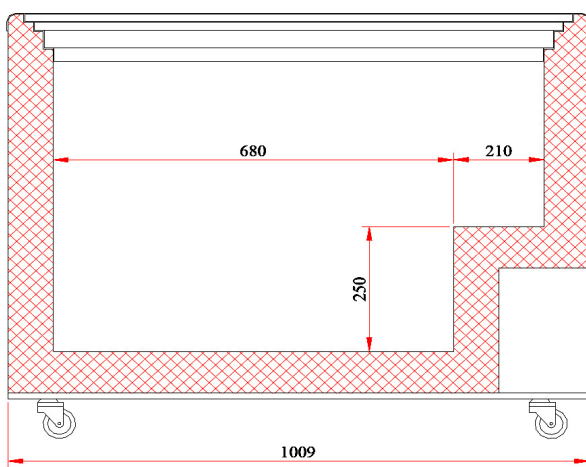

SPECIFICATIONS

Part Number	3735302	Internal Light	No
Capacity	264L	No. of Lids	2
Temperature range	-22 to -12°C	Lid Type	Slide - Glass
Max. Ambient Temp	35°C	Lid Shape	Curved
Refrigeration Capacity	220W	Lid Lock	Yes
Energy Consumption	2.9kWh/24h	Temp. Controller	Digital
Current	1.9A	Castors	Yes
Gross Weight	70kg	No. Baskets Included	4
Packaged Dimensions	1040 x 680 x 980 mm	Colour	White
Air-Circulation	Static	Warranty	2 Years, Parts & Labour
Refrigerant	R404a	Warranty Service	Bromic Extra Care
Plug Supplied	Yes, 1 x 10A		
Plug Location	2m long, bottom right rear		

DIMENSIONS

	External (mm)	Internal (mm)
Width	1010	890
Depth	615	510
Height	949	708

All information is correct at the time of publication. BROMIC PTY Ltd reserve the right to alter specifications without notice.