

CAMBRO

Adjustable Dish Caddy

For 4⁵/₈" to 13" (11,7 to 33 cm) Plates

Model ADCS

StoreSafe

Features & Benefits

- Adjusts to hold plates from 4⁵/₈" - 13" (11,7 to 33 cm) in diameter.
- Each caddy includes six adjustable towers. Each storage column is 19¹/₂" (49,5 cm) deep for safe stacking capacity of approximately 45 - 60 plates per column.
- Poker chip style offers greater access for easy plate removal.
- Structural web molded of heavy-duty polyethylene. Will not rust, crack or chip. Easy to clean.
- A 3/4" (1,9 cm) plated steel rear axle offers solid strength.
- One 1/2" (1,3 cm) metal rod runs inside each tower from top to bottom for stable and secure positioning.
- Molded-in handles on both ends provide sturdy and controlled handling. Will not bend or break.
- 500 lb. (226,8 Kg) load capacity.
- Non-marking wheels and casters ensure smooth maneuvering over any surface. Two each 5" (12,7 cm) swivel w/ brake front casters and 2 each 10" (25,4 cm) rear Easy Wheels.
- Vinyl cover included for sanitary storage.
- No assembly required.
- Available in 4 colors.

Item No. _____

Specifier Identification No. _____

Model No. _____

Quantity _____

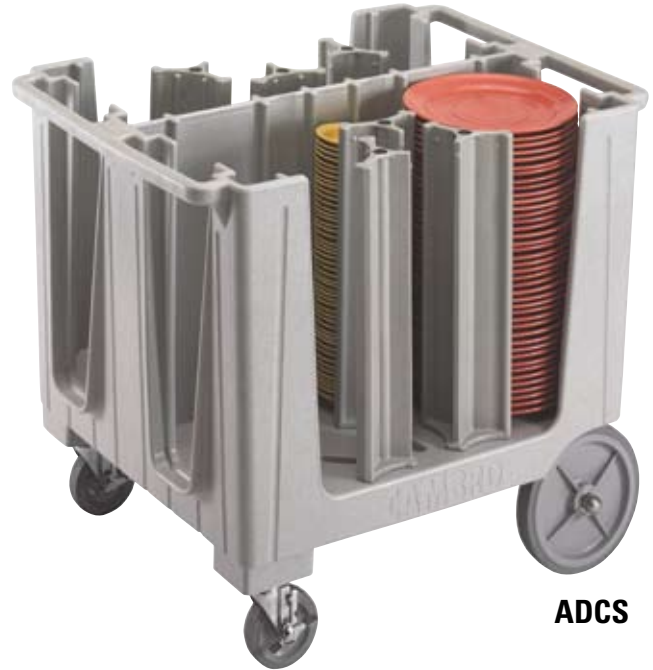

ADCS

Approvals



CAMBRO
MANUFACTURING COMPANY
www.cambro.com

© 2006 Cambro Manufacturing Company 5801 Skylab Road, Huntington Beach, California 92647-2056-U.S.A.
Telephone (1)714 848 1555 Toll Free 800 854 7631 Customer Service Hot Line 800 833 3003
LIT FCST - 0506

Adjustable Dish Caddy

For 4⁵/₈" to 13" (11,7 to 33 cm) Plates
Model ADCS

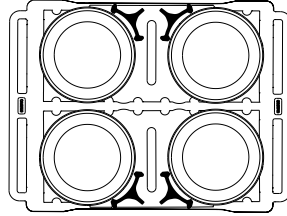
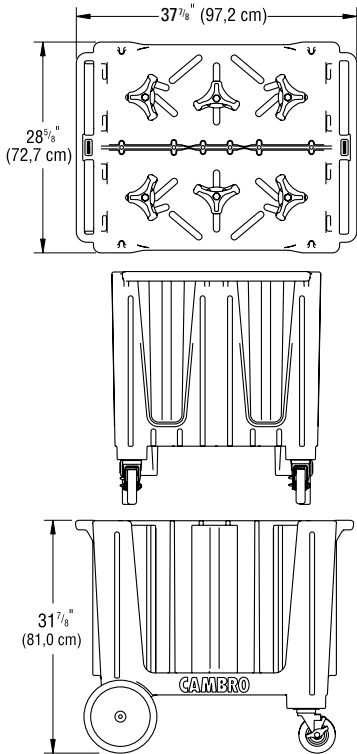

Plate Sizes: 9¹/₄"-13"
4 Columns (60 ea.)
Capacity = 240

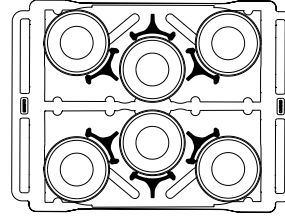

Plate Sizes: 7¹/₄"-9"
6 Columns (60 ea.)
Capacity = 360

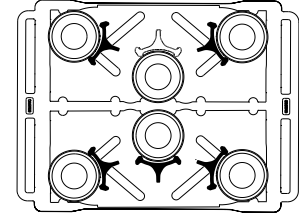
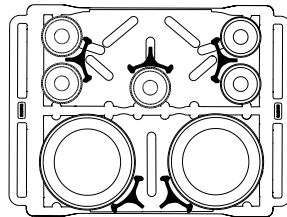
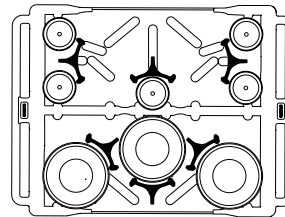

Plate Sizes: 5³/₄"-7"
6 Columns (45 ea.)
Capacity = 270



2 Columns 9¹/₄"-13" (60 ea.)
5 Columns 4³/₄" (45 ea.)
Capacity = 345



3 Columns 7¹/₄"-9" (60 ea.)
5 Columns 4³/₄" (45 ea.)
Capacity = 405

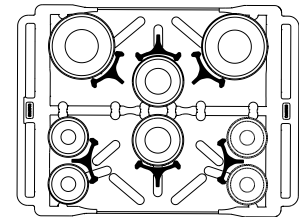

2 Columns 7¹/₄"-9" (60 ea.)
2 Columns 5³/₄"-7" (45 ea.)
4 Columns 4³/₄" (45 ea.)
Capacity = 390

Capacities are approximate and will vary depending upon thickness and shape of china.

Specifications

Dimension Tolerance: +/- 1/4" (0,64 cm)

Code	Description	Plate Size	Towers Per Caddy	Max Stacking Height Per Column	Approx. Depth Per Column	Dimensions W x L x H	Case lbs./Cube Kg/m ³
ADCS	S-Series Adjustable Dish Caddy	4 ⁵ / ₈ " to 13" 11,7 cm to 33 cm	6	Approximately 45-60 dishes	19 ¹ / ₂ " (49,5 cm)	28 ⁵ / ₈ " x 37 ¹ / ₈ " x 31 ¹ / ₈ " 72,7 x 97,2 x 81,0 cm	128 (19,9)/ 58,2 (0,56)

Standard Colors

- Black (110)
- Speckled Gray (480)
- Slate Blue (401)
- Dark Brown (131)

Architect Specs

The plate storage and transport cart shall be an S-Series Adjustable Dish Caddy, Model ADCS, manufactured by Cambro Mfg. Co., Huntington Beach, CA 92647 U.S.A. It shall be made of structural web molded polyethylene. It shall have 6 each adjustable towers. It shall offer per column storage of 19¹/₂" (49,5 cm) safe stacking height and shall offer plate-stacking capacity of approx. 45-60 plates per column. It shall accommodate 4⁵/₈" - 13" (11,7 - 33 cm) plates. Towers will feature a 3/4" (1,3 cm) metal rod from top to bottom. It shall have a 3/4" (1,9 cm) plated steel rear axle and 2 each 5" (12,7 cm) front swivel casters w/ brakes and 2 each 10" (25,4 cm) rear Easy Wheels. It shall have a load capacity of 500 lbs. (226,8 Kg). It shall include one vinyl cover. It shall be available in 4 colors.

Approvals



© 2006 Cambro Manufacturing Company 5801 Skylab Road, Huntington Beach, California 92647-2056-U.S.A.
Telephone (1)714 848 1555 Toll Free 800 854 7631 Customer Service Hot Line 800 833 3003
LIT FCST - 0506