

Camshelving®



No Bolts,
No Nuts

CAMGUARD
ANTIMICROBIAL SHELF PLATES



Easy and Quick to Clean



Easy to Adjust and Configure



Unquestionably Strong,
Durable and Stable



Rust Free



Store and
Transport
Food Safely



Dishwasher Safe
Except mobile
parts.



Fit for Food
Products



Cadmium-Free



Recyclable
Polypropylene

Consultant Cut Sheets and CAD
drawings are available on
www.cambro.com

Camshelving is covered by EU Patent #0686817 A2.

Easy And Quick To Clean

For A Sanitary Storage Area

- Shelf plates are easy to remove and run through the dishwasher.
- Smooth polypropylene surface quickly wipes clean.
- Spills clean quickly and easily, reducing the risk of cross-contamination.
- Camshelving® is weldless, so liquids and dirt cannot get inside crevices.

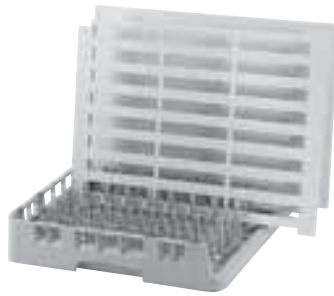

Shelf plates can be placed in an open end Camrack® OETR314 and washed in a commercial dishwasher.



- A silver-ion technology that inhibits the growth of mold, fungus and bacteria.
- Camguard works continuously to suppress the growth of microbes between cleanings.
- All shelf plates are embedded with Camguard antimicrobial so it will not scrape off, wash off or wear out.



Strong And Durable

Strong As Steel

- Posts and traverses are the weight bearing components, constructed with a steel core and encapsulated by a thick polypropylene outer layer.
- Inner steel core ensures that Camshelving is strong, durable and stable.
- Thick, polypropylene outer layer will not chip, break or corrode.
- Post connectors provide exceptional cross stabilization.



Weight bearing components are made with a steel core.

Weight Bearing Capacity

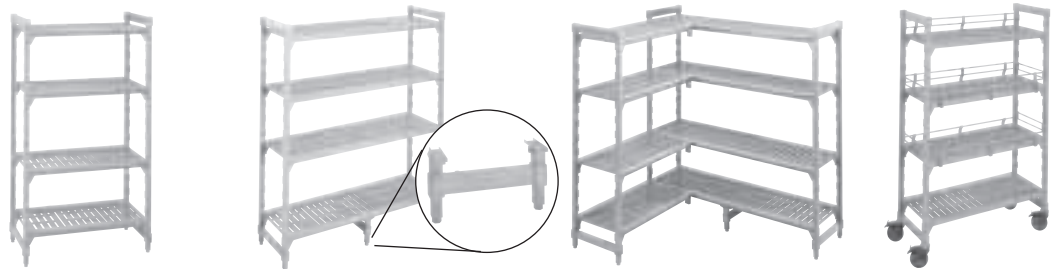

	SINGLE UNIT - 4 SHELVES	SINGLE UNIT - 4 SHELVES	DUNNAGE STAND	CORNER UNIT	MOBILE UNIT
TRAVERSE LENGTH	610 to 1220 mm	1370 to 1830 mm	1300 to 1830 mm	610 to 1220 mm	610 to 1220 mm
WEIGHT BEARING CAPACITY PER SHELF	363 Kg	272 Kg	454 Kg	181 Kg	—
WEIGHT BEARING CAPACITY PER UNIT WITH 4 SHELVES	1451 Kg	1089 Kg	—	726 Kg	340 Kg

Dunnage Stands are used only on the bottom shelf. Recommended for traverses 1370 mm or longer.

Corner Connectors are recommended for use on traverses 1220 mm or less.

Due to the weight bearing capacity of casters, maximum weight load on an entire Mobile Camshelving Unit is 340 Kg.

Easy To Assemble & Adjust

Build Any Configuration and Fit Any Size Area

- Create a space efficient layout for any area.
- Assembles in minutes, requiring only the use of a mallet.
- Shelves can be adjusted in 100 mm increments without disassembling the entire unit.
- Two units can be connected together with shelves at alternating heights for maximum storage flexibility.
- Corner Connectors attach units to create a 90° angle or U shape.

POST HEIGHT	DOVETAIL INCREMENT	NUMBER OF POSITIONS PER POST
Stationary		
820 mm	100 mm	6
1430 mm	100 mm	12
1630 mm	100 mm	14
1830 mm	100 mm	16
2140 mm	100 mm	19
Mobile		
890 mm	100 mm	6
1500 mm	100 mm	12
1700 mm	100 mm	14
1910 mm	100 mm	16

Rust Free

For Use in Any Area, Wet or Dry

- Camshelving is weldless with no exposed metal, so it remains rust free.
- Safe to -38°C, making Camshelving the ideal shelving system for freezers, walk-ins or any wet or humid environment.
- Not even salt water or sea air will corrode Camshelving.



Lifetime limited warranty against rust and corrosion for traverses and stationary posts.

HACCP

EASY TO ADJUST!

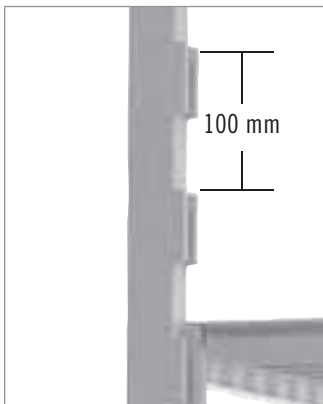

Shelves can be adjusted in 100 mm increments, without disassembling the unit.

EASY TO ASSEMBLE!

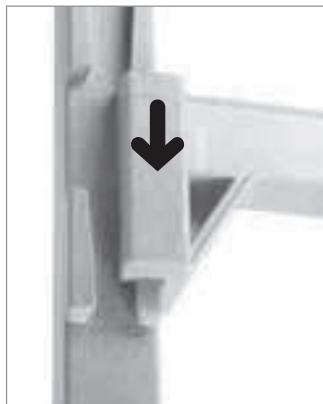

Traverses slide easily down onto dovetail.



Dry Storage Room



Cold Storage Room

Camshelving® Consulting & Wall shelf Kits



Free Camshelving Consulting Service

Cambro provides a free consulting service using our proprietary computer program. To contact the Camshelving Consulting Department, just call Cambro at 1 (714) 230-4113 or fax to 1 (714) 230-4199 or e-mail to mperez@cambro.com. Provide the dimensions of the storage space,

number of shelves per unit, height of the posts and any other special requirements you have. Cambro will provide a recommended floor plan and product order list. Your Cambro Distributor or Sales Representative will contact you with pricing. There is no cost or obligation to use the Cambro Consulting Service.

Components

Camshelving is a modular system that allows the flexibility to assemble shelving to fit any size area. The key components, including posts, post connectors, traverses and shelf plates, are available in a variety of sizes.

They can be easily configured to custom build shelving to maximize storage space. Unique design elements such as shared posts and corner connectors simplify assembly and increase storage capacity.

Traverses

Traverses have a steel core with a polypropylene exterior to provide strength and durability.

Traverses connect to the post by sliding on to the dovetail on the post.

Two traverses are needed to build one shelf, and they define the length of the unit.

Shelf Plates

Shelf Plates are made of polypropylene. Dishwasher safe.

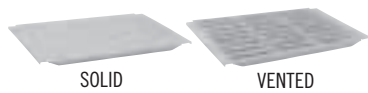

Shelf Kit
Includes two Traverses and Shelf Plates to fit the length of the Traverses

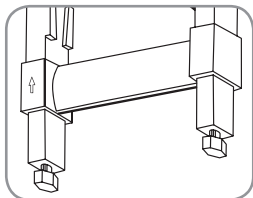

Posts For Stationary Unit

Posts have a steel core with a polypropylene exterior to provide strength and durability.

Posts define the height of the shelving unit and are measured with the leveling foot fully engaged.

Post for Stationary unit



Post Connectors

Post connectors hold two posts together and define the width of the unit.

They are made of polypropylene and provide excellent cross stabilization.

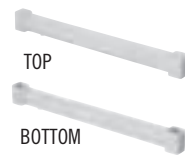

POST KIT
Includes two Posts and a set of one top and one bottom Post Connector

Posts for Mobile Camshelving

Mobile Camshelving posts must be used to build mobile Camshelving units.



Castors

Available in standard for dry storage or premium for freezers, cold, or wet applications.

Maximize Space Utilization

Camshelving is available in starter and add-on units for ease of ordering and assembly.

Starter Units

- Available in stationary or mobile units.
- Starter units ship complete with two post kits, traverses and shelf plates to build an entire unit.

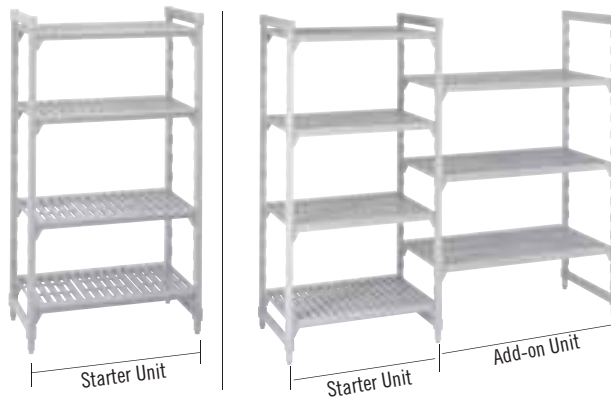

Add-On Units

- Add-On units ship complete with one post kit, traverses and shelf plates to attach to an adjoining unit.
- The traverses on both the first and second unit share the middle post.
- No add-on clips or S-hooks required.
- There is no loss of weight bearing capacity when built in a straight line.



Corner Unit & U Shape Units

- Corner connectors can be used to build corner units and U Shape units.
- Traverses snap onto corner connectors just like they snap onto the dovetails of the posts.

Corner Connector Set

- Attaches a basic unit to a second unit at a 90° angle or to form a U shape.
- A set of corner connectors are needed for each shelf.

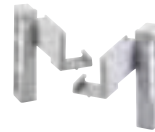

* Corner connectors are recommended for use on traverses equal to or shorter than 1220 mm, and covered by U.S. Patent D498,664S.

Dunnage Stand

- Increases weight bearing capacity to 454 kg on the bottom shelf.
- Recommended for units 1380 mm or longer.



* Dunnage stands are covered by U.S. Patent US 6,981,454B2.

Fence System

- Prevents stored items from falling off shelving units.
- Ideal for mobile shelving.

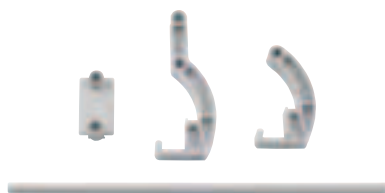

Mobile Units

- Mobile Camshelving units are built by using posts for mobile carts and inserting casters.
- Mobile units are not designed to serve as transport carts.



Mobile unit shown with optional fencing.

Seismic Foot

- Bolts a post to the floor for a more stable base.
- Screws not included.



Wall Fastener

- Fastens a unit to a wall as a safety precaution.
- Screws not included.



Identification Tag

- Easily clips onto traverses to identify stored items.
- Made of PVC.
- Includes 12 HACCP labels.



Donut Bumper

- Protects mobile Camshelving.
- 90 mm Bumper.

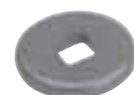

Camshelving® Footprint Dimensions

- The following charts are provided to assist in developing a footprint for your storage area.
- They can also be used to help determine your actual shelf space.
- Traverse measurements are based on outside, or overall unit length.
- This includes the posts.
- The overall length varies slightly when using a basic unit, add-on unit, intermediate unit or corner unit.
- These variations are outlined below.

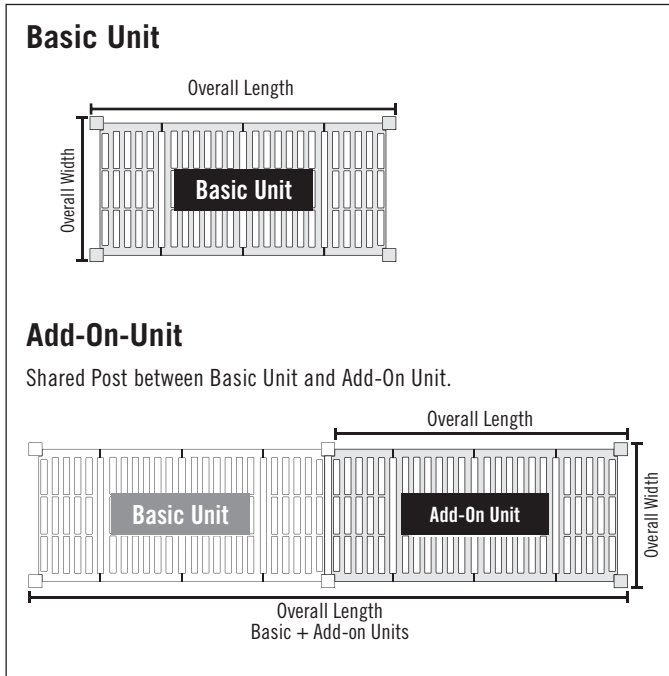

UNIT	BASIC UNIT OVERALL LENGTH	ADD-ON UNIT OVERALL LENGTH	BASIC + ADD-ON UNIT OVERALL LENGTH
610 mm	610 mm	565 mm	1175 mm
760 mm	760 mm	720 mm	1480 mm
910 mm	910 mm	870 mm	1780 mm
1070 mm	1070 mm	1025 mm	2095 mm
1220 mm	1220 mm	1175 mm	2395 mm
1380 mm	1380 mm	1330 mm	2710 mm
1530 mm	1530 mm	1480 mm	3010 mm
1830 mm	1830 mm	1790 mm	3620 mm

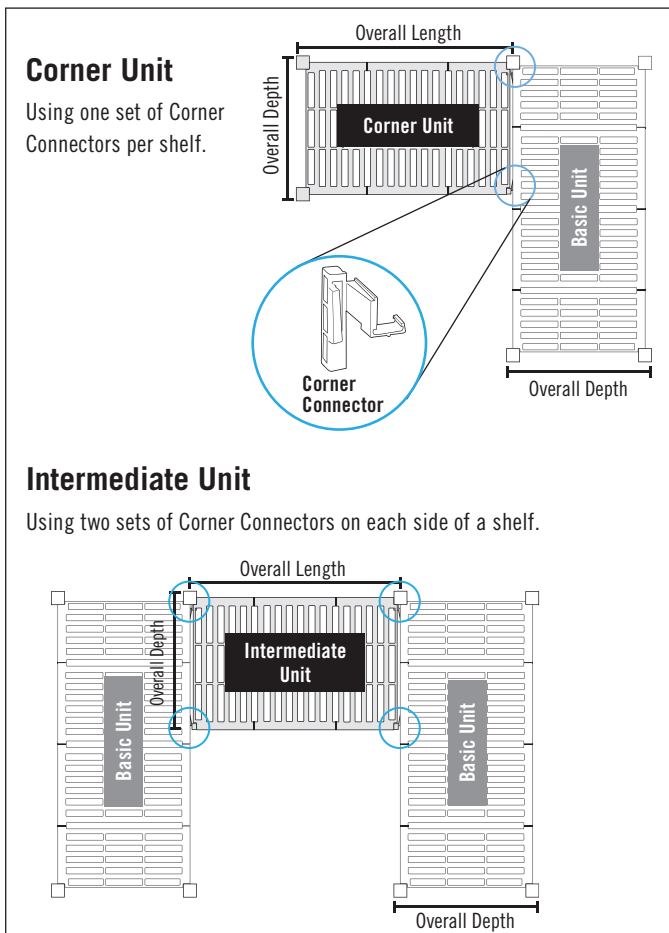

UNIT	CORNER UNIT OVERALL LENGTH	INTERMEDIATE UNIT OVERALL LENGTH
610 mm	585 mm	560 mm
760 mm	740 mm	715 mm
910 mm	890 mm	865 mm
1070 mm	1045 mm	1020 mm
1220 mm	1195 mm	1170 mm

Corner Connectors are recommended for use on traverses 1220 mm or less.

Shelf Spacing

Dovetails are spaced every 100 mm



POST HEIGHT	DOVETAIL INCREMENT	NUMBER OF POSITIONS PER POST
Stationary		
820 mm	100 mm	6
1430 mm	100 mm	12
1630 mm	100 mm	14
1830 mm	100 mm	16
2140 mm	100 mm	19
Mobile		
890 mm	100 mm	6
1500 mm	100 mm	12
1700 mm	100 mm	14
1910 mm	100 mm	16



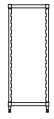
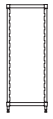
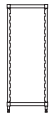
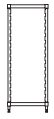





Stationary Post Kits

					
HEIGHT	WIDTH	360 mm	460 mm	540 mm	610 mm
820 mm	CODE	CSPK1432	CSPK1832	CSPK2132	CSPK2432
	CASE KG/CUBE M ³	2,27 (0,009)	2,45 (0,009)	2,59 (0,009)	2,82 (0,009)
1430 mm	CODE	CSPK1456	CSPK1856	CSPK2156	CSPK2456
	CASE KG/CUBE M ³	6,10 (0,0135)	6,26 (0,0135)	6,40 (0,0135)	6,58 (0,0135)
1630 mm	CODE	CSPK1464	CSPK1864	CSPK2164	CSPK2464
	CASE KG/CUBE M ³	7,0 (0,0155)	6,9 (0,012)	7,18 (0,013)	7,48 (0,0155)
1830 mm	CODE	CSPK1472	CSPK1872	CSPK2172	CSPK2472
	CASE KG/CUBE M ³	7,80 (0,0164)	7,73 (0,013)	7,8 (0,015)	8,28 (0,0164)
2140 mm	CODE	CSPK1484	CSPK1884	CSPK2184	CSPK2484
	CASE KG/CUBE M ³	9,05 (0,0192)	8,6 (0,016)	8,71 (0,015)	8,94 (0,015)

Case Pack: 1

Color: Speckled Gray (480).









Solid Shelf Kits

									
WIDTH	LENGTH	610 mm	760 mm	910 mm	1070 mm	1220 mm	1380 mm	1530 mm	1830 mm
360 mm	CODE	CS1424SK	CS1430SK	CS1436SK	CS1442SK	CS1448SK	CS1454SK	CS1460SK	CS1472SK
	CASE KG/CUBE M ³	3,53 (0,0235)	4,36 (0,0235)	5,19 (0,0235)	6,03 (0,0274)	6,85 (0,0300)	7,43 (0,046)	18,30 (0,0390)	10,07 (0,0470)
460 mm	CODE	CS1824SK	CS1830SK	CS1836SK	CS1842SK	CS1848SK	CS1854SK	CS1860SK	CS1872SK
	CASE KG/CUBE M ³	3,36 (0,025)	4,22 (0,0235)	5,47 (0,0235)	6,53 (0,0274)	7,16 (0,0300)	8,22 (0,0351)	9,05 (0,0390)	10,84 (0,0470)
540 mm	CODE	CS2124SK	CS2130SK	CS2136SK	CS2142SK	CS2148SK	CS2154SK	CS2160SK	CS2172SK
	CASE KG/CUBE M ³	4,14 (0,0235)	5,12 (0,0235)	5,36 (0,037)	6,65 (0,046)	8,03 (0,0300)	8,45 (0,048)	9,33 (0,053)	11,15 (0,065)
610 mm	CODE	CS2424SK	CS2430SK	CS2436SK	CS2442SK	CS2448SK	CS2454SK	CS2460SK	CS2472SK
	CASE KG/CUBE M ³	4,20 (0,0235)	5,27 (0,0235)	6,33 (0,0235)	7,12 (0,046)	7,88 (0,037)	9,56 (0,0351)	10,41 (0,039)	12,65 (0,0470)

Case Pack: 1

Color: Speckled Gray (480).

Vented Shelf Kits





									
WIDTH	LENGTH	610 mm	760 mm	910 mm	1070 mm	1220 mm	1380 mm	1530 mm	1830 mm
360 mm	CODE	CS1424VK	CS1430VK	CS1436VK	CS1442VK	CS1448VK	CS1454VK	CS1460VK	CS1472VK
	CASE KG/CUBE M ³	2,99 (0,025)	4,15 (0,0235)	4,43 (0,037)	5,23 (0,045)	6,51 (0,0300)	7,31 (0,0351)	7,29 (0,053)	8,90 (0,065)
460 mm	CODE	CS1824VK	CS1830VK	CS1836VK	CS1842VK	CS1848VK	CS1854VK	CS1860VK	CS1872VK
	CASE KG/CUBE M ³	3,60 (0,0235)	2,43 (0,0235)	5,19 (0,0235)	5,82 (0,045)	6,78 (0,0300)	7,16 (0,044)	8,53 (0,0390)	9,66 (0,066)
540 mm	CODE	CS2124VK	CS2130VK	CS2136VK	CS2142VK	CS2148VK	CS2154VK	CS2160VK	CS2172VK
	CASE KG/CUBE M ³	3,93 (0,0235)	2,84 (0,0235)	5,33 (0,029)	6,34 (0,035)	6,88 (0,038)	8,73 (0,0351)	8,95 (0,053)	11,58 (0,0470)
610 mm	CODE	CS2424VK	CS2430VK	CS2436VK	CS2442VK	CS2448VK	CS2454VK	CS2460VK	CS2472VK
	CASE KG/CUBE M ³	3,72 (0,025)	3,06 (0,026)	5,65 (0,037)	6,94 (0,0274)	7,94 (0,0300)	8,56 (0,049)	9,67 (0,0390)	11,77 (0,0470)

Case Pack: 1

Color: Speckled Gray (480).

www.cambro.com

Vented Starter Units





WIDTH 460 mm						
HEIGHT	LENGTH	910 mm	1070 mm	1220 mm	1380 mm	1530 mm
1630 mm	CODE - 4 SHELVES	CSU48366	CSU48426	CSU48486	CSU48546	CSU48606
	CASE KG/CUBE M ³	35,09 (0,150)	39,04 (0,150)	38,28 (0,16)	46,00 (0,1506)	44,27 (0,158)
1630 mm	CODE - 5 SHELVES	CSU58366	CSU58426	CSU58486	CSU58546	CSU58606
	CASE KG/CUBE M ³	40,28 (0,150)	45,22 (0,150)	48,21 (0,1506)	53,16 (0,1506)	51,53 (0,1506)
1830 mm	CODE - 4 SHELVES	CSU48367	CSU48427	CSU48487	CSU48547	CSU48607
	CASE KG/CUBE M ³	35,38 (0,160)	37,50 (0,157)	40,52 (0,161)	47,00 (0,1506)	45,66 (0,163)
1830 mm	CODE - 5 SHELVES	CSU58367	CSU58427	CSU58487	CSU58547	CSU58607
	CASE KG/CUBE M ³	42,73 (0,170)	49,17 (0,1506)	55,00 (0,1506)	53,07 (0,1506)	

Case Pack: 1

Color: Speckled Gray (480).

* Dimensions provided with line drawings above are actual dimensions.

Vented Add-On Units





WIDTH 460 mm						
HEIGHT	LENGTH	910 mm	1070 mm	1220 mm	1380 mm	1530 mm
1630 mm	CODE - 4 SHELVES	CSA48366	CSA48426	CSA48486	CSA48546	CSA48606
	CASE KG/CUBE M ³	27,92 (0,1506)	31,88 (0,1506)	34,27 (0,1506)	38,50 (0,1506)	41,28 (0,1506)
1630 mm	CODE - 5 SHELVES	CSA58366	CSA58426	CSA58486	CSA58546	CSA58606
	CASE KG/CUBE M ³	33,11 (0,1506)	38,06 (0,1506)	37,92 (0,167)	46,00 (0,1506)	49,80 (0,1506)
1830 mm	CODE - 4 SHELVES	CSA48367	CSA48427	CSA48487	CSA48547	CSA48607
	CASE KG/CUBE M ³	28,08 (0,1506)	32,04 (0,1506)	34,43 (0,1506)	39,00 (0,1506)	41,44 (0,1506)
1830 mm	CODE - 5 SHELVES	CSA58367	CSA58427	CSA58487	CSA58547	CSA58607
	CASE KG/CUBE M ³	33,27 (0,1506)	38,21 (0,1506)	41,21 (0,1506)	47,00 (0,1506)	45,54 (0,168)

Case Pack: 1

Color: Speckled Gray (480).

* Dimensions provided with line drawings above are actual dimensions.

Vented Starter Units





WIDTH 540 mm						
HEIGHT	LENGTH	910 mm	1070 mm	1220 mm	1380 mm	1530 mm
1630 mm	CODE - 4 SHELVES	CSU41366	CSU41426	CSU41486	CSU41546	CSU41606
	CASE KG/CUBE M ³	37,61 (0,200)	42,24 (0,200)	41,73 (0,205)	49,53 (0,2007)	47,81 (0,205)
1630 mm	CODE - 5 SHELVES	CSU51366	CSU51426	CSU51486	CSU51546	CSU51606
	CASE KG/CUBE M ³	40,28 (0,200)	44,36 (0,203)	47,63 (0,203)	54,44 (0,203)	62,82 (0,2007)
1830 mm	CODE - 4 SHELVES	CSU41367	CSU41427	CSU41487	CSU41547	CSU41607
	CASE KG/CUBE M ³	41,73 (0,200)	43,83 (0,200)	46,48 (0,2007)	46,54 (0,206)	46,41 (0,199)
1830 mm	CODE - 5 SHELVES	CSU51367	CSU51427	CSU51487	CSU51547	CSU51607
	CASE KG/CUBE M ³	44,95 (0,200)	45,08 (0,209)	54,05 (0,2007)	53,52 (0,2007)	57,52 (0,2007)

Case Pack: 1

Color: Speckled Gray (480).

* Dimensions provided with line drawings above are actual dimensions.

Vented Add-On Units





WIDTH 540 mm		 *	 *	 *	 *	 *
HEIGHT	LENGTH	910 mm	1070 mm	1220 mm	1380 mm	1530 mm
1630 mm	CODE - 4 SHELVES	CSA41366	CSA41426	CSA41486	CSA41546	CSA41606
	CASE KG/CUBE M ³	30,31 (0,2007)	34,94 (0,2007)	37,59 (0,2007)	42,23 (0,2007)	45,88 (0,2007)
1630 mm	CODE - 5 SHELVES	CSA51366	CSA51426	CSA51486	CSA51546	CSA51606
	CASE KG/CUBE M ³	36,06 (0,2007)	41,84 (0,2007)	41,64 (0,203)	45,54 (0,203)	49,9 (0,203)
1830 mm	CODE - 4 SHELVES	CSA41367	CSA41427	CSA41487	CSA41547	CSA41607
	CASE KG/CUBE M ³	31,10 (0,2007)	35,73 (0,2007)	38,38 (0,2007)	43,02 (0,2007)	39,4 (0,213)
1830 mm	CODE - 5 SHELVES	CSA51367	CSA51427	CSA51487	CSA51547	CSA51607
	CASE KG/CUBE M ³	36,86 (0,2007)	42,64 (0,2007)	45,95 (0,2007)	51,76 (0,2007)	56,31 (0,2007)

Case Pack: 1

Color: Speckled Gray (480).

* Dimensions provided with line drawings above are actual dimensions.

Vented Starter Units





WIDTH 610 mm		 *	 *	 *	 *	 *
HEIGHT	LENGTH	910 mm	1070 mm	1220 mm	1380 mm	1530 mm
1630 mm	CODE - 4 SHELVES	CSU44366	CSU44426	CSU44486	CSU44546	CSU44606
	CASE KG/CUBE M ³	37,38 (0,237)	42,75 (0,200)	46,72 (0,2007)	51,00 (0,2007)	51,17 (0,226)
1630 mm	CODE - 5 SHELVES	CSU54366	CSU54426	CSU54486	CSU54546	CSU54606
	CASE KG/CUBE M ³	44,70 (0,200)	49,69 (0,200)	54,66 (0,2007)	60,00 (0,2007)	63,32 (0,2007)
1830 mm	CODE - 4 SHELVES	CSU44367	CSU44427	CSU44487	CSU44547	CSU44607
	CASE KG/CUBE M ³	39,01 (0,228)	42,18 (0,232)	45,81 (0,223)	52,50 (0,2007)	53,07 (0,234)
1830 mm	CODE - 5 SHELVES	CSU54367	CSU54427	CSU54487	CSU54547	CSU54607
	CASE KG/CUBE M ³	44,09 (0,23)	51,28 (0,200)	52,84 (0,231)	62,50 (0,2007)	60,24 (0,229)

Case Pack: 1

Color: Speckled Gray (480).

* Dimensions provided with line drawings above are actual dimensions.

Vented Add-On Units

WIDTH 610 mm		 *	 *	 *	 *	 *
HEIGHT	LENGTH	910 mm	1070 mm	1220 mm	1380 mm	1530 mm
1630 mm	CODE - 4 SHELVES	CSA44366	CSA44426	CSA44486	CSA44546	CSA44606
	CASE KG/CUBE M ³	30,9 (0,206)	35,26 (0,2007)	38,03 (0,029)	43,50 (0,2007)	46,17 (0,2007)
1630 mm	CODE - 5 SHELVES	CSA54366	CSA54426	CSA54486	CSA54546	CSA54606
	CASE KG/CUBE M ³	35,74 (0,229)	42,21 (0,2007)	47,17 (0,2007)	52,50 (0,2007)	55,84 (0,2007)
1830 mm	CODE - 4 SHELVES	CSA44367	CSA44427	CSA44487	CSA44547	CSA44607
	CASE KG/CUBE M ³	32,06 (0,2007)	36,06 (0,2007)	39,31 (0,232)	44,00 (0,2007)	45,36 (0,240)
1830 mm	CODE - 5 SHELVES	CSA54367	CSA54427	CSA54487	CSA54547	CSA54607
	CASE KG/CUBE M ³	38,01 (0,2007)	43,0 (0,2007)	47,97 (0,2007)	53,00 (0,2007)	56,63 (0,2007)

Case Pack: 1

Color: Speckled Gray (480).

* Dimensions provided with line drawings above are actual dimensions.