



The spray system produces clear and transparent ice cubes and the patented **Bright Cube** shape grants a longer lasting cube for you to enjoy your cold drinks

Self contained ice maker.  
Up to 40kg production per 24/hr of medium ice cube.  
15kg storage bin.  
Complete with legs, water & drain hoses + 1 ice scoop.  
10 AMP power supply.  
266 mm drain height including legs to finished floor.



## ICE PRODUCTION

### Air Cooled Unit

Air Temp.	Water Temperature			
				
°C	32°	21°	15°	10°
°F	90°	70°	60°	50°
10°	<b>32</b>	<b>37</b>	<b>40</b>	<b>41</b>
50°	71	82	88	90
21°	<b>27</b>	<b>32</b>	<b>35</b>	<b>37</b>
70°	60	71	77	82
32°	<b>21</b>	<b>26</b>	<b>28</b>	<b>30</b>
90°	46	57	62	66
38°	<b>18</b>	<b>23</b>	<b>25</b>	<b>27</b>
100°	40	51	55	60

### Water Cooled Unit

Air Temp.	Water Temperature			
				
°C	32°	21°	15°	10°
°F	90°	70°	60°	50°
10°	<b>33</b>	<b>38</b>	<b>41</b>	<b>42</b>
50°	73	84	90	93
21°	<b>29</b>	<b>35</b>	<b>38</b>	<b>40</b>
70°	64	77	84	88
32°	<b>28</b>	<b>34</b>	<b>37</b>	<b>39</b>
90°	62	75	82	86
38°	<b>26</b>	<b>33</b>	<b>36</b>	<b>38</b>
100°	57	73	79	84

## CUBE TYPE

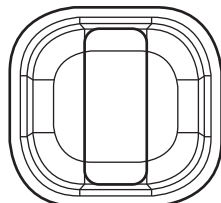
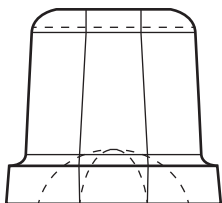

**20g weight**  
**BRIGHT CUBE**  
32mm x 35mm x 37mm

The Bright Ice Cube, appreciated for its versatility, is perfect for use in ice buckets, whiskey on the rocks, cocktails and appetisers. The crystal clear appearance of the Bright Cube makes it essential when a high quality is required.

## CONTROL PANEL



Switch On/Off

Ice size regulation screw

## BIN CAPACITY

15 kg - 33 lbs | 750 pcs

## DIMENSIONS

W x D x H (mm)

 500 x 540 x 690/810

 560 x 600 x 850

## OPERATING REQUIREMENTS

Rejected Heat 1655 W





Air Volume 185 m<sup>3</sup>/h















220-240/50/1



R134a GWP = 1430

MIN		MAX
10°C (50°F)		40°C (104°F)
5°C (41°F)		35°C (95°F)
- 10 %		+ 10 %
1 Bar (14 psi)		5 Bar (70 psi)

## SPECIFICATIONS

	 cond	 comp. W	 ABS. W	 Fuse	 kWh/100kg	 L / hr	 kg	 lbs	 kg	 lbs	 Ton CO2 equiv.
<b>CS40 A</b>		1144	590	10	39.4	2.73	39	86	48	106	0.33
<b>CS40 W</b>		1144	540	10	24.7	41.40	39	86	48	106	0.30

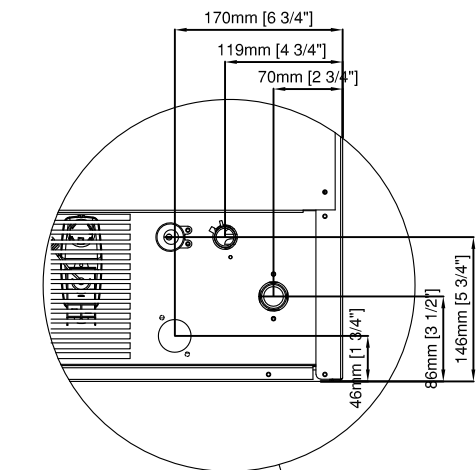

Back View  
Vista Posteriore

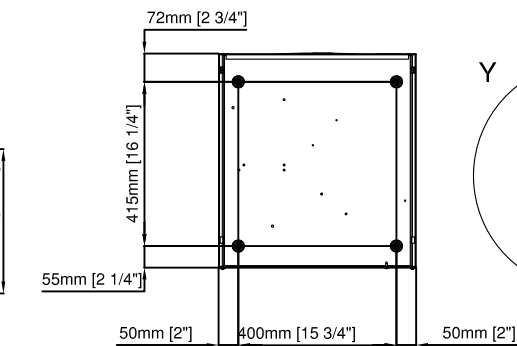

Front View  
Vista Frontale

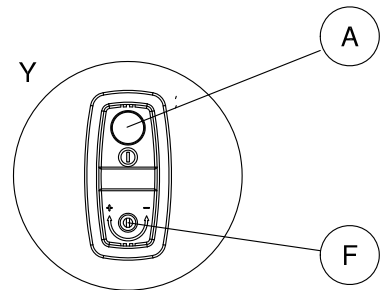

Lateral View  
Vista Laterale

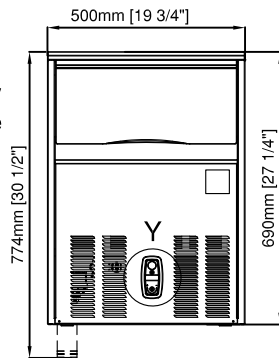

Top View  
Vista Superiore

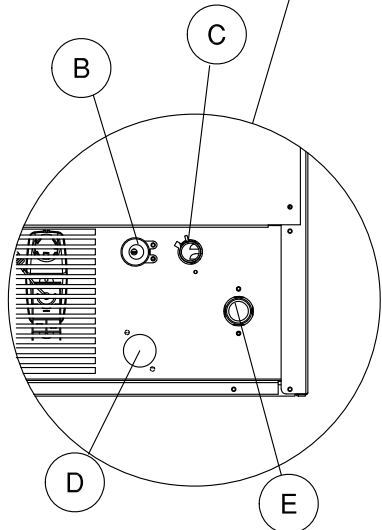
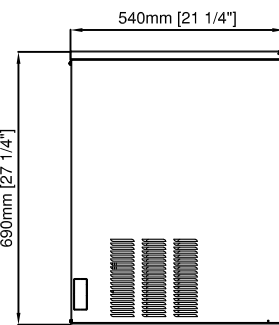

- A** Switch On/Off
- B** Electrical cable supply
- C** Water outlet connection 20mm diam.
- D** Water outlet connection water condensation 20mm diam.
- E** Water inlet connection 3/4" gas
- F** Ice size regulation screw