



Thanks to a continuous and regular flow, the water is distributed on a refrigerated surface designed to increase ice production. Three different sizes are available **FULL DICE, HALF DICE** and **LARGE DICE**

High production modular ice maker.  
Up to 130kg production per 24/hr of dice cube.  
Head only, stainless steel cabinet.  
Complete with water & drain hoses.  
10 AMP power supply.



## ICE PRODUCTION

### Air Cooled Unit

Air Temp.		Water Temperature			
		32°	21°	15°	10°
°C					
°F					
10°		<b>129</b>	<b>147</b>	<b>150</b>	<b>154</b>
50°		284	323	330	340
21°		<b>112</b>	<b>127</b>	<b>133</b>	<b>138</b>
70°		247	281	239	305
32°		<b>96</b>	<b>107</b>	<b>110</b>	<b>113</b>
90°		212	236	242	249
38°		<b>79</b>	<b>87</b>	<b>95</b>	<b>98</b>
100°		173	193	209	215

### Water Cooled Unit

Air Temp.		Water Temperature			
		32°	21°	15°	10°
°C					
°F					
10°		<b>123</b>	<b>131</b>	<b>134</b>	<b>136</b>
50°		271	289	295	300
21°		<b>111</b>	<b>121</b>	<b>126</b>	<b>128</b>
70°		245	267	278	282
32°		<b>102</b>	<b>110</b>	<b>117</b>	<b>119</b>
90°		225	243	258	262
38°		<b>100</b>	<b>108</b>	<b>115</b>	<b>116</b>
100°		221	238	254	256

### CONTROL PANEL

	Power
	Operating
	Bin Full / Washing
	Alarm
	High Pressure Alarm
	Reset Button / Washing

### SUGGESTED STORAGE BIN



BH56  
Stainless steel storage bin.  
120kg capacity.

### DIMENSIONS

W x D x H (mm)  
560 x 620 x 575

### OPERATING REQUIREMENTS

Rejected Heat	1731 W
Air Volume	590 m <sup>3</sup> /h
220-240/50/1	R404a GWP=3922
MIN	MAX
10°C (50°F)	40°C (104°F)
5°C (41°F)	35°C (95°F)
- 10 %	+ 10 %
1 Bar (14 psi)	5 Bar (70 psi)

## CUBE TYPE

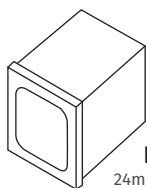

**10g**  
**FULL CUBE**  
24mm x 22mm x 22mm

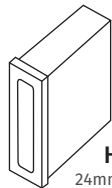



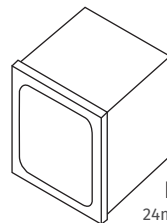







**6g**  
**HALF CUBE**  
24mm x 10mm x 29mm



**17g**  
**LARGE CUBE**  
24mm x 29mm x 29mm

Solid ice cube, suitable for quick drink cooling, available in three different sizes, **FULL DICE (M models)**, **HALF DICE (MH models)** and **LARGE DICE (ML models)**, can be used in various applications: ice buckets, whisky on the rocks and cocktails.

## SPECIFICATIONS

	 cond	 comp. W	 ABS. W	 Fuse	 kWh/100kg	 L / hr	 kg lbs		 kg lbs		 Ton CO2 equiv.
<b>M132 A</b>		1637	850	10	15.9	7.0	53	117	65	143	1.96
<b>M132 W</b>		1637	750	10	12.1	107.0	53	117	65	143	1.76

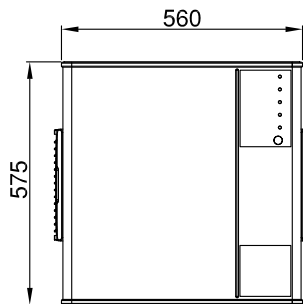

AIR COOLED

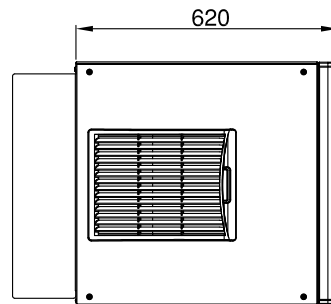

WATER COOLED

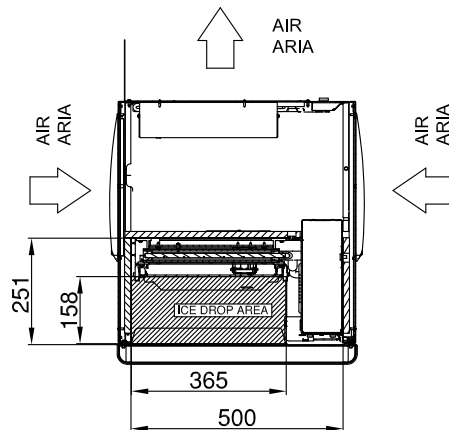
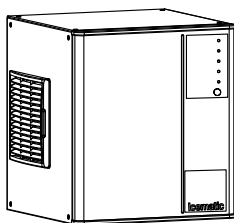
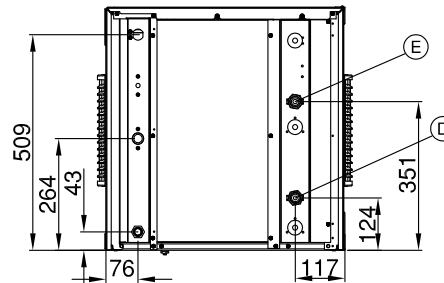
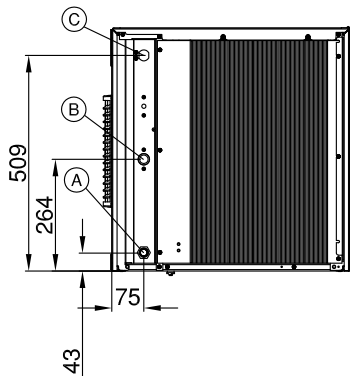

- (A) Water drain 20mm diam.
- (B) Potable water inlet 3/4" gas
- (C) Electrical cable supply
- (D) Water cooled inlet 3/4" gas
- (E) Water cooled outlet 3/4" gas