

Data sheet

iCombi® Classic 20-2/1 E



Capacity

- > 20 lengthwise insertion for 2/1 GN-Accessories
- > Mobile oven rack with 65 mm insertion distance and tandem rollers
- > Handle mount for mobile oven rack
- > Wide range of accessories for various cooking processes such as grilling, braising or baking
- > For use with 2/1, 1/1, 2/4 GN-Accessories

Combi-steamer mode

- > Steam 30 °C – 130 °C
- > Convection 30 °C – 300 °C
- > Combination of steam and convection from 30 °C - 300 °C

ClimaPlus

- > Climate management - humidity measurement and control
- > Humidity adjustment in 10% increments

Description

- > Combi-steamer in accordance with DIN 18866 for most cooking methods used in commercial kitchens for the optional use of steam and convection, individually, successively or together.

Unit description and functional features

Cooking functions

- > ClimaPlus: Active climate management in the cooking chamber, which constantly measures and regulates the humidity and ensures effective dehumidification with high productivity, cooking quality and low energy consumption. The humidity is set in 10% increments and can be tracked on the digital display for accurate manual cooking.
- > Dynamic air turbulence in the cooking chamber due to three reversing high-performance fan wheels with five manually programmable fan wheel speeds. The optimal energy input results in a high level of uniformity and short cooking times.
- > Effective steam generator for optimal steam performance even at low temperatures below 100 °C
- > Integrated, maintenance-free grease separation system with no additional grease filter
- > Cool-down function for fast cooling of the cooking chamber by means of a fan wheel
- > Core temperature measurement using a core temperature sensor and optional positioning aid (accessories)
- > Delta-T cooking for particularly gentle preparation with minimal cooking losses
- > Digital temperature display adjustable in °C or °F, display of target and actual values
- > Digital display of the cooking chamber humidity and time, display of target and actual values
- > Individual programming of up to 100 single or multi-level cooking programmes with up to 12 increments
- > Individual adjustment of the cooking parameters time, temperature and humidity of a programme increment during operation
- > Easy transfer of cooking programmes to other cooking systems with a USB stick
- > Integrated hand shower with automatic return and switchable spray and single jet function
- > Energy-saving, long-life LED lighting in the cooking chamber with high colour rendering for quick detection of the current state of food
- > Free hotlines for questions regarding technology and application support (ChefLine)

Occupational and operational safety

- > Electronic safety temperature limiter for steam generator and convection heating
- > Integrated fan wheel brake
- > Use of Active Green cleaner tabs and care tabs (solid matter cleaner) for optimal work safety
- > HACCP data memory and output via USB
- > Tested according to national and international standards for unsupervised operation
- > Maximum rack height 1.60 m when using the RATIONAL mobile oven rack with 20 racks, rail spacing 62 mm (omission of USPHS approval)

Networking

- > Integrated, IP-protected USB interface for local data exchange
- > Optional integrated, IP-protected Ethernet interface
- > Optional integrated WLAN interface (including Ethernet interface)

Cleaning and care

- > Non-mains pressure dependent automatic cleaning and care system for cooking cabinet and steam generator
- > Care system: Automatic cleaning and descaling of steam generator
- > 4 different cleaning programmes for unsupervised cleaning, even overnight
- > Simple and intuitive operation of the cleaning programmes: Display of the selected cleaning programme, the recommended amount of tabs and remaining cleaning time
- > Safe completion of cleaning after power failure with detergent-free cooking chamber
- > Use of phosphate and phosphorous free Active Green cleaning tabs and care tabs
- > Unit door with ventilated double glass pane and swivelling inner pane for easy cleaning
- > Material inside and outside stainless steel DIN 1.4301, seamless hygienic cooking chamber with rounded corners and optimised air flow
- > Easy and safe external cleaning due to glass and stainless steel surfaces as well as protection against water jets from all directions due to protection class IPX5

Operation

- > 4.3 inch TFT colour display and soft keys for simple, intuitive operation. Operating modes and functions are optically highlighted
- > Simple operation and exact settings due to the central setting wheel with push function
- > Acoustic prompt and visual display when user intervention is required

- > Exhaust/condensation hoods (accessories) with situation-specific customisation of suction power and transmission of service messages.

Installation, maintenance and environment

- > Professional installation by certified technicians recommended by RATIONAL
- > Fixed waste water connection conforming to SVGW requirements is permitted
- > Customisation to the installation location (height above sea level) with automatic calibration
- > Operation without water softeners and without additional manual descaling is possible
- > Installed flush with walls*
- > 2 pane cooking chamber door with integrated sealing mechanism for minimal energy loss
- > Service diagnosis system with automatic display of service messages
- > Regular maintenance is recommended. Maintenance according to the manufacturer's recommendations is available from RATIONAL service partners
- > RATIONAL 2 year guarantee** on new units (including parts, work and journey)
- > *For details, see the installation or designer manual
- > **Terms and conditions apply, see manufacturer's guarantee policy on the website www.rational-online.com

Options

- > MarineLine – Marine design
- > SecurityLine – Prison and security version
- > MobilityLine - Mobile design (can be ordered as a separate accessory)
- > HeavyDutyLine – particularly resilient design
- > Integrated fat drain
- > Safety door lock
- > Potential-free contact for connecting an external signal unit
- > Control panel protection
- > Lockable control panel
- > Capability to connect to an energy optimisation system
- > Integrated, IP-protected Ethernet interface
- > Integrated WLAN interface (including Ethernet interface)

Technical specifications

Dimensions and weight

Dimensions (W x H x D)	
Cooking system (body)	1082 x 1807 x 1052 mm
Cooking system (complete)	1082 x 1872 x 1117 mm
Cooking system with packaging	1190 x 2043 x 1218 mm
Maximum working height top rack*	≤ 1.60 m

*with use of the RATIONAL mobile oven rack model 20-2/1 with 20 racks, rail spacing 62 mm

Weight	
Maximum loading quantities/rack	9 kg
Maximum total loading quantities	180 kg
Weight electric unit without packaging	304 kg
Weight electric unit with packaging	350 kg
Weight gas unit without packaging	371 kg
Weight gas unit with packaging	417 kg

Connection requirements electric

Voltage 3 NAC 415 V	
Electrical connected loads	73.8 kW
Steam mode output	58.7 kW
Convection mode output	71.9 kW
Fuse	125 A
Connection impedance	0.09 Ω
RCD model	B

Connection requirements water

Water inlet (pressure hose) respectively	3/4"
Water pressure (flow pressure) respectively	1.0 – 6.0 bar
Water outlet respectively	DN 50
Maximum flow rate per cooking system	12 l/min

Connection conditions exhaust air and thermal load

Latent heat load	3026 W
Sensible heat output	3887 W
Noise level (electric)	60 dBA
Noise level (gas)	65 dBA

Connection requirements data

LAN data interface	RJ45
WiFi data interface	IEEE 802.11 a/g/n

Minimum clearances during installation

Minimum clearance	Left	Back	Right
Standard	50 mm	0 mm	50 mm

- > Comprehensive technical information on kitchen planning and unit installation can be found in the planning manual or in the installation instructions on our business customer portal.

Installation conditions

- > If heat sources act on the left side of the unit, the minimum distance on the left must be 350 mm.
- > Specific national and regional standards and regulations which concern the installation and operation of commercial cooking appliances must be complied with. The local standards and regulations for ventilation systems must be adhered to.

Certifications



Technical drawing Electric

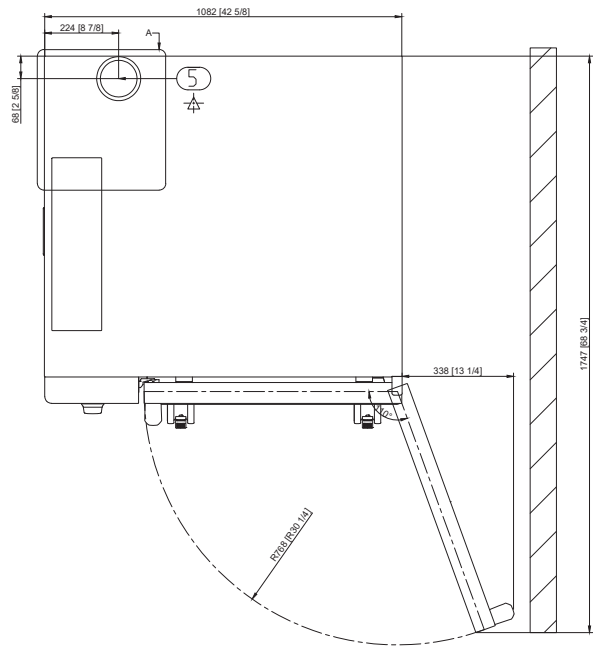
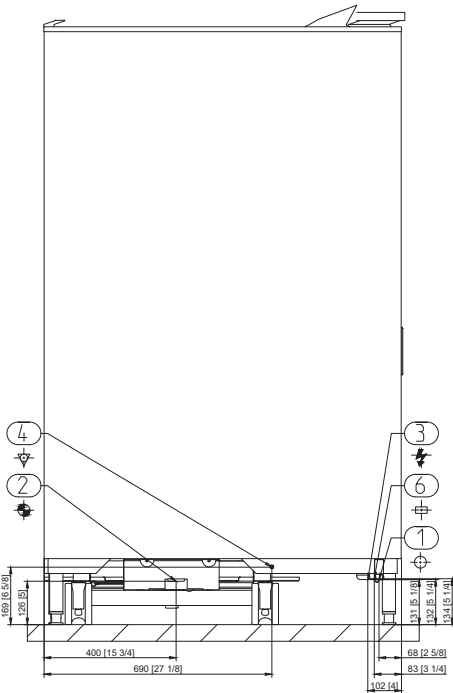
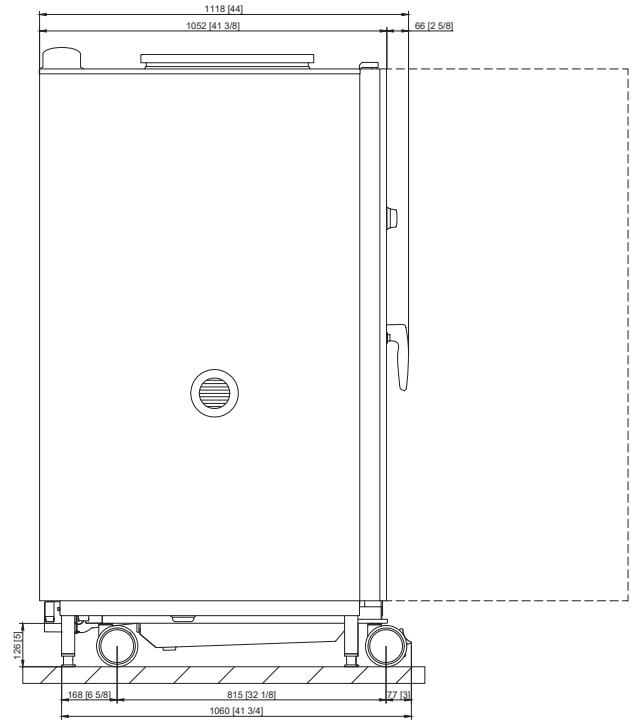
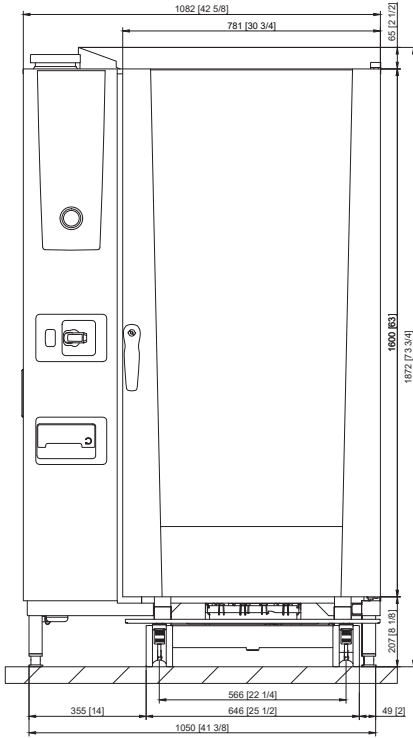

1	Water inlet
2	Water outlet
3	Electrical connection
4	Equipotential bonding
5	Ventilation pipe
6	Ethernet interface

Accessories

Accessories	Article number
RATIONAL Active Green cleaner tabs - guarantees the best cleaning performance	
RATIONAL care tabs – effectively prevents limescale deposits	
Unit installation kit	
Mobile oven rack trolleys and plate rack trolleys - for easy loading outside the cooking system	
Finishing systems for banquets	
Heat shield - to install a unit next to a heat source, e.g. a grill	
Condensation breaker - to divert steam and vapours into existing exhaust systems	
UltraVent condensation hood – only for electric units	
Additional impact protection elements for HeavyDutyLine	
RATIONAL USB stick – for the safe transfer of cooking programmes and HACCP data	

To achieve an optimal cooking result, you will find a wide range of cooking accessories and information on additional accessories in the accessories brochure, from your distributor or at www.rational-online.com

Planner	RATIONAL Australia
	156 Swann Drive, Derrimut, VIC, 3026 Tel. +61 3 8369 4600 Fax: +61 3 8369 4699 E-Mail: sales@rationalaustralia.com.au Visit us on the internet: www.rationalaustralia.com.au