

robot *coupe*®

IMMERSION BLENDERS



RESTAURANTS - CATERERS - DELICATESSENS

COMPACT

MINI

▶ Mini MP

▶ CMP

▶ MP Ultra



MicroMix

Mini MP 160 V.V. Mini MP 190 V.V. Mini MP 240 V.V.

For handling smaller quantities

2 000 to 12 500 rpm



CMP 250 V.V. CMP 300 V.V. CMP 350 V.V. CMP 400 V.V.

15 litres 30 litres 45 litres 73 litres

2 300 to 9 600 rpm



MP 350 Ultra MP 450 Ultra MP 550 Ultra

50 litres 100 litres 200 litres

MP 350/MP 450 : 9 500 rpm
MP 350 V.V./MP 450 V.V. : 1 500 to 9 000 rpm

▶ Special for emulsions

▶ For handling smaller quantities

▶ Special catering models up to 73 litres

▶ Specially designed / commercial catering

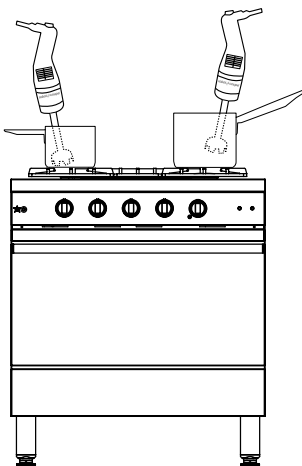

MicroMix Mini MP

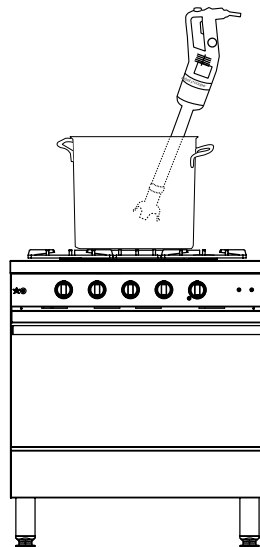

CMP

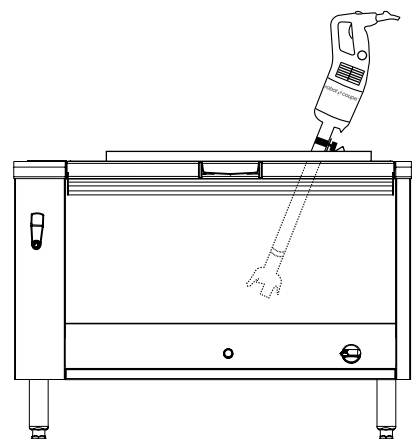

MP Ultra

COMBI

▶ Mini MP - CMP - MP Ultra - MP FW Ultra

1000 W



600 mm

740 mm

350 W



MP 600 Ultra

MP 800 Turbo

300 litres

400 litres

9 500 rpm

9 500 rpm

270 W



190 mm



185 mm

240 mm

Mini MP 190 Combi

Mini MP 240 Combi

290 W

For handling smaller quantities

Mixer: 2 000 to 12 500 rpm
Whisk: 350 to 1 560 rpm

NEW

310 W



250 mm

350 W



220 mm

300 mm

CMP 250 Combi

CMP 300 Combi

15 litres

30 litres

Mixer: 2 300 to 9 600 rpm
Whisk: 500 to 1 800 rpm

440 W



350 mm

500 W



280 mm

450 mm

MP 350 Combi Ultra

MP 450 Combi Ultra

50 litres

100 litres

Mixer: 1 500 to 9 000 rpm
Whisk: 250 to 1 500 rpm

500 W



MP 450 FW Ultra

100 litres

250 to 1 500 rpm



▶ MINI RANGE

▶ Mixer



▶ Emulsify



▶ Beat



FOR HANDLING SMALLER QUANTITIES

COMBI



Mini MP
160 V.V.

Mini MP
190 V.V.

Mini MP
240 V.V.

2 000 to
12 500 rpm



Mini MP
190 Combi

Mini MP
240 Combi

Mixer: 2 000 to 12 500 rpm
Whisk: 350 to 1 560 rpm

More information on page 10

▶ MINI RANGE

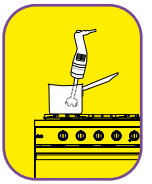

Minimum size, maximum performance!
For sauces, emulsions and small preparations.

VARIABLE SPEED

- 2 000 to 12 500 rpm in mixer function
- 350 to 1 560 rpm in whisk function

ERGONOMICS

Shape of the handle specifically designed to ensure a good grip and manipulation of the Immersion Blender, thus reducing user fatigue.

POWERFUL

A powerful motor (240-290 W according to model) for an even longer lifespan!



HYGIENE

Detachable tube and blade assembly for perfect hygiene, with a patented system exclusive to Robot-Coupe. Tube, bell and blade assembly all made from stainless steel for a longer lifespan. The Mini MP 190 V.V. and Mini MP 240 V.V. models have a detachable bell.

MULTIPURPOSE



Overmoulded stainless-steel blades ensuring perfect hygiene and ideal for making coulis, cream soups and sauces.



Detachable stainless-steel emulsifying disc for aerating hot and cold sauces and giving them a foamy consistency.



▶ COMPACT RANGE CMP

NEW

▶ Mixer



▶ Beat



SPECIALLY DESIGNED FOR THE CATERING SECTOR



2 300 to 9 600 rpm

COMBI

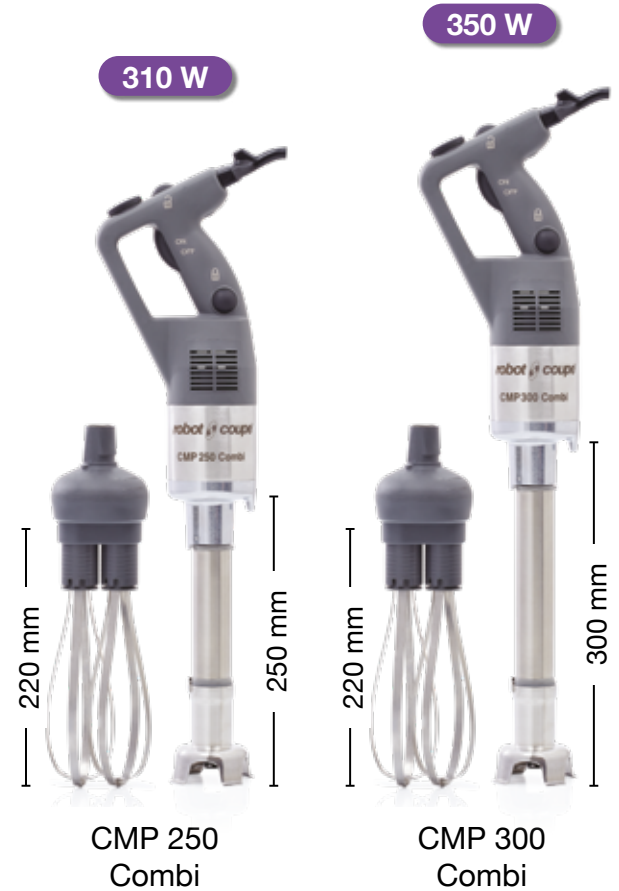

Mixer: 2 300 to 9 600 rpm

Whisk: 500 to 1 800 rpm

▶ COMPACT RANGE CMP

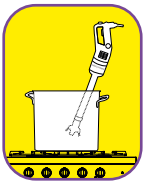

Compact, easy-to-handle, high-performance.
For restaurants & cafés

ERGONOMICS

Light, compact, easy-to-handle appliance.

POWERFUL

More powerful motor:
+ 15% for even more efficient machine.



HYGIENE

Removable stainless steel blade and bell for easy cleaning and maintenance.

MULTIPURPOSE



The CMP Combi models (mixer+whisk) also boast a new 100% stainless-steel bell



Optimum blending quality giving the finished product a fine texture in minimal time.



CONVENIENT

Variable speed function providing the greater flexibility required for **sophisticated preparations.**

INNOVATION



ERGONOMICS

The lug on the motor base can be used to rest the mixer on the rim of a pan to make it easier to handle and remove some of the strain.

New cord winder to make it easier to store and prevent wear and tear.



AFTER SALES SERVICE: DETACHABLE POWER CORD

- 1 The new patented "EasyPlug" system** means that the power cord can be easily replaced during after-sales servicing.
- 2 Indicator light:** rapid detection of power cord failure. The green light comes on if the cord is undamaged and correctly plugged in on both sides (wall socket and EasyPlug).



▶ LARGE RANGE

▶ Mixer



▶ Beat



SPECIALLY DESIGNED / COMMERCIAL CATERING

NEW

440 W



MP 350 Ultra

350 mm

500 W



MP 450 Ultra

450 mm

750 W



MP 550 Ultra

550 mm

850 W



MP 600 Ultra

600 mm

1000 W



MP 800 Turbo

740 mm

COMBI

440 W



MP 350 Combi Ultra

350 mm

500 W



MP 450 Combi Ultra

280 mm

500 W



MP 450 F.W.C. Ultra

450 mm

MP 350/MP 450 : 9 500 rpm MP 350 V.V./MP 450 V.V. : 1 500 to 9 000 rpm	9 000 rpm	9 500 rpm	9 500 rpm	Mixer: 1 500 to 9 000 rpm Whisk: 250 to 1 500 rpm	250 to 1 500 rpm
-----------------------------------------------------------------------------------------------	-----------	-----------	-----------	--------------------------------------------------------------------	------------------------

More information on page 10

▶ LARGE RANGE

MP ULTRA LARGE PRODUCT RANGE

Even better performance and ergonomics!

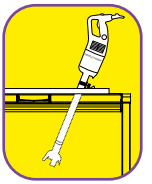

ERGONOMICS

Ergonomic handle for greater convenience.



For the MP V.V. and MP Combi models, **more ergonomic variable speed button** for greater convenience.

PERFORMANCE

High-Power motor: **+20%** for greater efficiency. Increased performance to **optimise blending time.**

LONG SERVICE LIFE

Stainless steel motor base for intensive use.

robot coupe
MP 450 Ultra

INNOVATION



ERGONOMICS

The lug on the motor base can be used to rest the mixer on the rim of a pan to make it easier to handle and remove some of the strain.

New cord winder to make it easier to store and prevent wear and tear.

INNOVATION



STAINLESS
STEEL
BELL

HYGIENE

Removable stainless steel bell and blade for easy cleaning and maintenance.

NEW



New EasyGrip removable handle.

The machine's weight is distributed better making it even easier to use!

AFTER SALES SERVICE: DETACHABLE POWER CORD

- 1 The new patented "EasyPlug" system** means that the power cord can be easily replaced during after-sales servicing.
- 2 Indicator light:** rapid detection of power cord failure. The green light comes on if the cord is undamaged and correctly plugged in on both sides (wall socket and EasyPlug).



INNOVATION

▶ MP/CMP PAN SUPPORTS

They enable the immersion blender to be tilted effortlessly or left to do the job by itself. Made entirely of stainless steel, they can be removed completely, are easy to clean and practical to use.

Adjustable pan supports:

Three pan supports are available as an option. They adapt to the size of the pan:

- pan Ø from 330 mm to 650 mm.
- pan Ø from 500 mm to 1 000 mm.
- pan Ø from 850 mm to 1 300 mm.



Universal pan support:

Fits all pan sizes.



▶ COMBI PRODUCT RANGE

The Robot-Coupe whisk attachment available for Mini MP Combi, CMP Combi, MP Combi Ultra and MP FW mixers is designed to emulsify, mix, shell, beat and knead.

POWERFUL

High-strength motor: +15 % for greater efficiency.

EASY TO OPERATE

Variable speed button easy to use with one hand.

ERGONOMIC

Ergonomic handle for easier grasping.

CONVENIENT

Self regulating speed system for sophisticated preparations.



Mini MP

CMP

MP

METAL WHISK BOX



HEAVY DUTY

Metal gears inside 2 metal housings to stand up to heavy duty use.

HYGIENE

Overmoulded whisks to ensure perfect hygiene.

ERGONOMIC

Fast coupling of whisks to the gearbox and the gearbox to the motor housing for easy assembly and disassembly.

▶ MIXING TOOL ATTACHMENT

Ergonomic handle

Rubber protection

- **Variable speed** from 150 to 510 rpm
- Total length of the tool : **690 mm**
- **Available as an optional extra with the Ultra Combi models.**

Uses:

potato flakes, dehydrated base for soups etc...

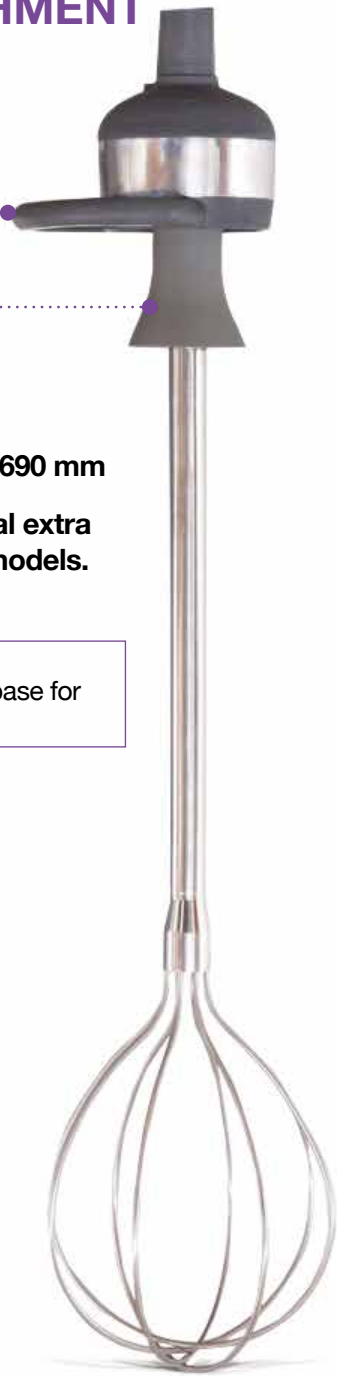

▶ FOOD HYGIENE ADVICE CLEANING

Bell and blade removable for ease of cleaning

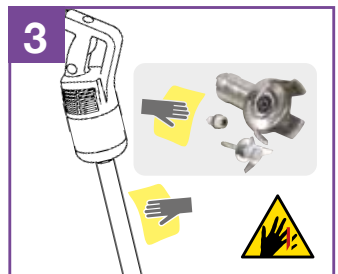
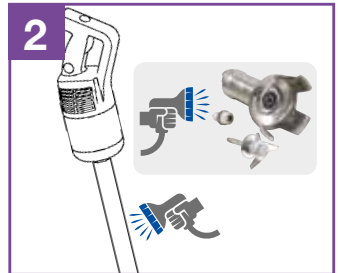
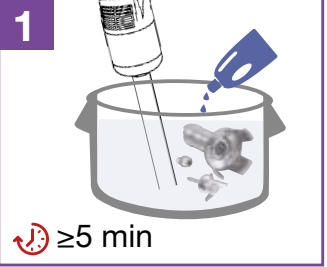

In line with HACCP advice, the cleaned bell and blade should be stored in a cold room after use

EXCLUSIVE TECHNOLOGY

The main benefits

- **Perfect hygiene:** Foot, knife, bell, and whisk fully removable - a Robot-Coupe exclusive.
- **Robust machine:** The design of the machines and the materials used in their construction guarantee a sturdy machine.
- **Large processing capacity:** Powerful motor for fast processing and an optimum quality end-product.
- **Easy maintenance:** All stainless steel tube, bell, knife and whisk.
- **Compact models:** Space saving and easy to use. 5 models to process small quantities.



Pan capacity

Between 2 and 400 litres according to the model.



Targets

Restaurants, Caterers, Delicatessens, Day Nurseries.



In Brief

The performance in terms of hygiene, ease of use, multiple functions, longer life, and profitability make it the best choice on the market.

CE
mark

	Electrical data			Dimensions (in mm)				Weight (kg)	
	Variable speed (rpm)	Power (Watts)	Voltage* (Amp.)	A	B	C	D	net	gross
MicroMix	1 500 to 14 000	220	230 V/50Hz - 1,1	68	430	61	165	1.07	1.44

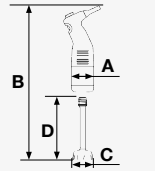

MINI RANGE	Electrical data			Dimensions (in mm)				Weight (kg)	
	Variable speed (rpm)	Power (Watts)	Voltage* (Amp.)	A	B	C	D	net	gross
Mini MP 160 V.V.	2 000 to 12 500	240	230 V/50Hz - 1,1	78	430	65	160	1,41	1,94
Mini MP 190 V.V.	2 000 to 12 500	270	230 V/50Hz - 1,3	78	470	65	190	1,5	1,97
Mini MP 240 V.V.	2 000 to 12 500	290	230 V/50Hz - 1,5	78	520	65	240	1,5	2,00

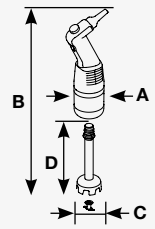

COMPACT RANGE	Electrical data			Dimensions (in mm)				Weight (kg)	
	Variable speed (rpm)	Power (Watts)	Voltage* (Amp.)	A	B	C	D	net	gross
CMP 250 V.V.	2 300 to 9 600	310	230V/50 Hz - 1,4	94	619	95	255	3,0	4,7
CMP 300 V.V.	2 300 to 9 600	350	230V/50 Hz - 1,6	94	669	95	305	3,1	4,8
CMP 350 V.V.	2 300 to 9 600	400	230V/50 Hz - 1,7	94	727	95	363	3,3	5,0
CMP 400 V.V.	2 300 to 9 600	420	230V/50 Hz - 1,9	94	786	90	413	3,8	4,3

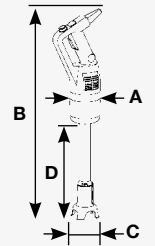

RANGE LARGE	Electrical data				Dimensions (in mm)						Weight (kg)	
	Speed (rpm)		Power (Watts)	Voltage* (Amp.)	A	B	C	D	E	F	net	gross
	Mixer	Mixer Variable speed										
MP 350 Ultra	9 500	-	440	230V/50 Hz 2,1	125	725	100	360	-	-	4,6	6,1
MP 350 V.V. Ultra	-	1 500 to 9 000	440	230V/50 Hz 2,1	125	725	100	360	440	120	4,8	6,3
MP 450 Ultra	9 500	-	500	230V/50 Hz 2,3	125	825	100	460	-	-	4,9	6,4
MP 450 V.V. Ultra	-	1 500 to 9 000	500	230V/50 Hz 2,3	125	825	100	460	440	120	5,0	6,4
MP 550 Ultra	9 000	-	750	230V/50 Hz 3,5	125	960	111	560	-	-	5,2	6,7
MP 600 Ultra	9 500	-	850	230V/50 Hz 3,4	124	998	110	580	-	-	5,7	7,6
MP 800 Turbo	9 500	-	1000	230V/50 Hz 4,5	125	1130	110	740	-	-	7,1	9

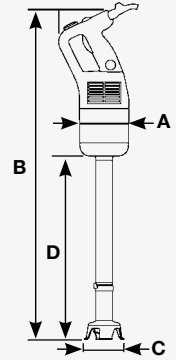

COMBI RANGE	Electrical data				Dimensions (in mm)						Weight (kg)	
	Mixer Variable speed (rpm)	Whisk Variable speed (rpm)	Power (Watts)	Voltage* (Amp.)	A	B	C	D	E	F	net	gross
Mini MP 190 Combi	2 000 to 12 500	350 to 1 560	270	230V/50 Hz 1,3	78	470	65	190	255	100	1,95	2,68
Mini MP 240 Combi	2 000 to 12 500	350 to 1 560	290	230V/50 Hz 1,5	78	520	65	240	255	100	1,98	2,70
CMP 250 Combi	2 300 to 9 600	500 to 1 800	310	230V/50 Hz 1,4	94	667	95	255	390	120	3,0	4,7
CMP 300 Combi	2 300 to 9 600	500 to 1 800	350	230V/50 Hz 1,6	94	717	95	305	390	120	3,1	4,8
MP 350 Combi Ultra	1 500 to 9 000	250 to 1 500	440	230V/50 Hz 2,1	125	775	100	410	440	120	5,9	8,3
MP 450 Combi Ultra	1 500 to 9 000	250 to 1 500	500	230V/50 Hz 2,3	125	875	100	510	440	120	6,1	8,5
MP 450 FW Ultra	-	250 to 1 500	500	230V/50 Hz 2,3	125	805	-	-	440	120	4,3	6,5
MP 450 XL FW Ultra	-	250 to 1 500	500	230V/50 Hz 2,3	150	1175	-	-	815	175	5,3	8,5

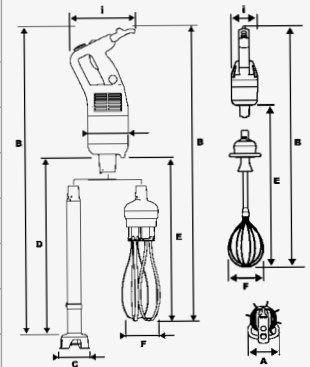

*Other voltages available.

robot coupe

HEAD OFFICE, FRENCH, EXPORT AND MARKETING DEPARTMENT:

Tel.: + 33 1 43 98 88 33

email: international@robot-coupe.com

Robot Coupe Australia: Tel.: (02) 9478 0300

New Zealand: Tel.: 0800 716161

email: orders@robotcoupe.com.au

Robot Coupe U.K. LTD: Tel.: 020 8232 1800

2, Fleming Way, Isleworth, Middlesex TW7 6EU

email: sales@robotcoupe.co.uk

Robot Coupe U.S.A.: Tel.: 1-800-824-1646

email: info@robotcoupeusa.com - website: www.robotcoupeusa.com

www.robot-coupe.com

Distributor

STANDARDS:

Machines in compliance with :



- The following European directives and related national legislation: 2006/42/CE, 2014/35/UE, 2014/30/UE, 2011/65/UE, 2012/19/UE, 1907/2006/CE, 1935/2004/CE, 2023/2006/CE, 10/2011/UE.
- The following European harmonized standards and standards setting out health and safety rules: EN ISO 12100:2010, EN 60204-1:2006, EN 60529: IP 55, IP 34, EN 12853.

We reserve the right to alter at any time without notice the technical specifications of this appliance. None of the information contained in this document is of a contractual nature. Modifications may be made at any time.
© All rights reserved for all countries by : ROBOT-COUPÉ s.n.c.

Ref : 451 543 - 03/2023 - Anglais