



Flake ice is generated through a vertical cylinder, with an internal auger which scrapes the ice from the internal surface of the evaporator. This produces uniform flake ice with a residual water content

Low water content super flaker.

Up to 540kg production per 24/hr of super flake ice.

Head only.

Stainless steel cabinet.

Complete with water & drain hoses.

15 AMP, 2.2kW power supply.



ICE PRODUCTION

Air Cooled Unit

| Air Temp. |  | Water Temperature | | | |
|-----------|---|-------------------|------------|------------|------------|
| | | 32° | 21° | 15° | 10° |
| °C | | 21° | 15° | 10° | |
| °F | | 70° | 60° | 50° | |
| 10° | | 440 | 520 | 560 | 600 |
| 50° | | 970 | 1146 | 1234 | 1323 |
| 21° | | 420 | 500 | 540 | 580 |
| 70° | | 926 | 1102 | 1190 | 1278 |
| 32° | | 380 | 440 | 470 | 500 |
| 90° | | 838 | 970 | 1036 | 1102 |
| 38° | | 330 | 370 | 390 | 410 |
| 100° | | 727 | 816 | 860 | 904 |

Water Cooled Unit

| Air Temp. |  | Water Temperature | | | |
|-----------|---|-------------------|------------|------------|------------|
| | | 32° | 21° | 15° | 10° |
| °C | | 21° | 15° | 10° | |
| °F | | 70° | 60° | 50° | |
| 10° | | 480 | 540 | 570 | 600 |
| 50° | | 1058 | 1190 | 1256 | 1323 |
| 21° | | 470 | 530 | 560 | 590 |
| 70° | | 1036 | 1168 | 1234 | 1300 |
| 32° | | 460 | 520 | 550 | 580 |
| 90° | | 1014 | 1146 | 1212 | 1278 |
| 38° | | 450 | 513 | 540 | 570 |
| 100° | | 992 | 1131 | 1190 | 1256 |

ICE TYPE

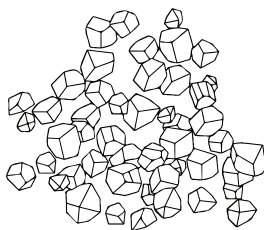

15-18%
SUPERFLAKE ICE
residual water content

Flake ice has a lot of uses, from the conservation and display of fresh fish to cocktail creation and juice bars. Flake ice is also used in hospitals and during the production of sausages and bread, to chill the mix. Flake ice is extremely versatile.

CONTROL PANEL



SUGGESTED STORAGE BIN



BH76+KBT14
Stainless steel storage bin.
244kg capacity.

DIMENSIONS

W x D x H (mm)
538 x 663 x 790

OPERATING REQUIREMENTS





| | |
|---------------|------------------------|
| Rejected Heat | 6447 W |
| Air Volume | 1500 m ³ /h |















220-240/50/1



R404a GWP=3922

| MIN | | MAX |
|----------------|---|----------------|
| 10°C (50°F) |  | 40°C (104°F) |
| 5°C (41°F) |  | 35°C (95°F) |
| - 10 % |  | + 10 % |
| 1 Bar (14 psi) |  | 5 Bar (70 psi) |

SPECIFICATIONS

| |  cond |  comp. W |  ABS. W |  Fuse |  kWh/100kg |  L / hr |  kg |  lbs |  kg |  lbs |  Ton CO2 equiv. |
|----------------|--|---|--|--|---|--|--|---|--|---|--|
| SF500 A |  | 5030 | 2000 | 16 | 10.2 | 18 | 95 | 207 | 104 | 227 | 3.84 |
| SF500 W |  | 5030 | 2000 | 16 | 8.7 | 185 | 95 | 207 | 104 | 227 | 2.75 |

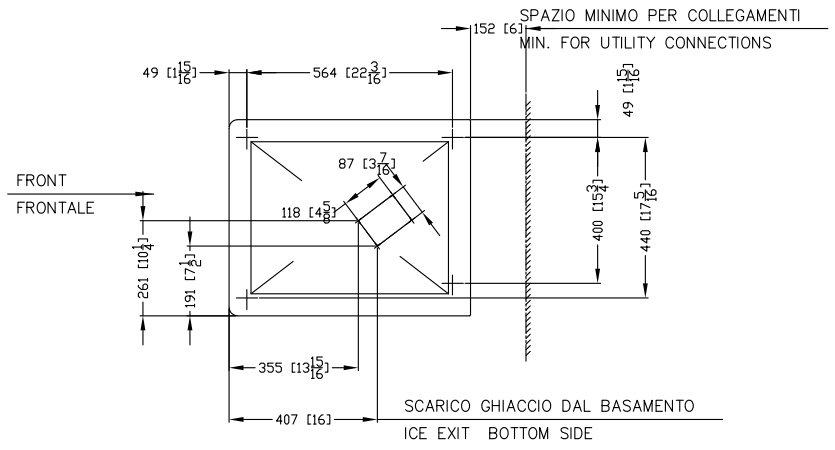
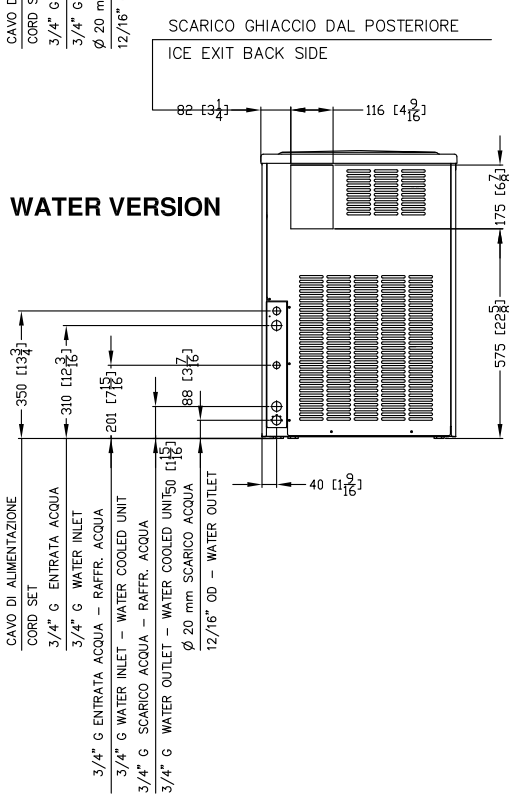
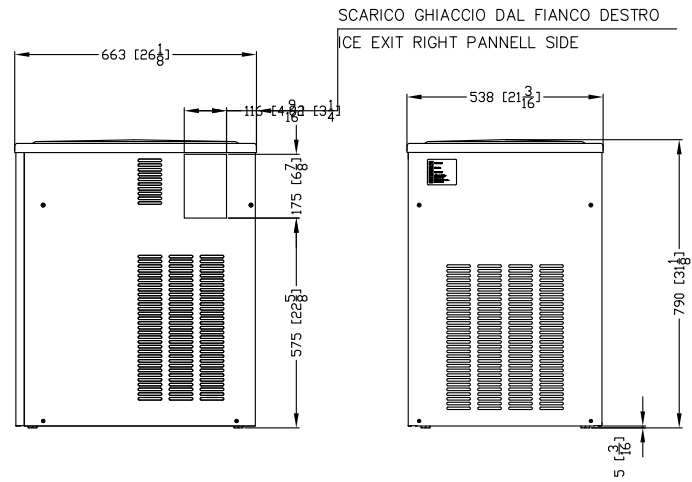
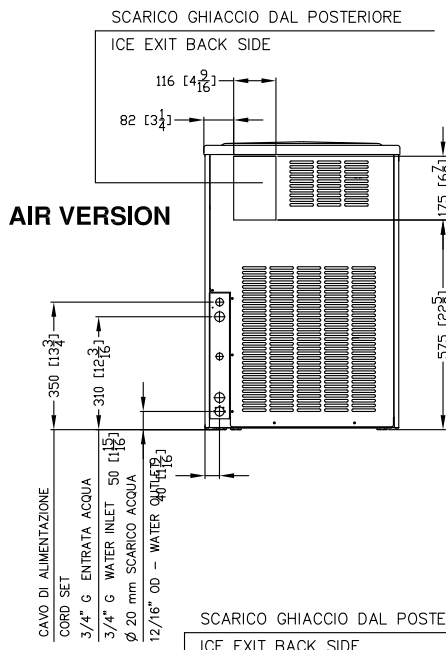

NOTE:
IF THE UNIT IS INSTALLED AS A BUILT-IN/UNDERCOUNTER,
BETWEEN 5 AND 10 mm ON EACH SIDE MUST BE CONSIDERED
TO ALLOW FOR EASE OF INSTALLATION