



Austune Commercial Pty Ltd
 Unit 1, 79-85 Mars Road
 Lane Cove West NSW 2066
 Tel: (02) 9420 4477
 www.austunecommercial.com

CHEF BASE - D815 REFRIGERATOR
MODEL : TCBE-96SDR



- Drawer Pans Not Included

FEATURES / BENEFITS

- STRONG BODY AND DURABLE CONSTRUCTION**
 Built with heavy duty, stainless steel Chef Base top is manufactured of one-piece reinforced stainless steel to ensure durability.
- DURABLE STAINLESS STEEL DRAWERS**
 Drawers are easy to clean and assemble.
- TOP IS INSULATED TO ELIMINATE HEAT TRANSFER TO THE INTERIOR OF CABINET**
- EFFICIENT REFRIGERATION SYSTEM**
 Turbo Air's solid door refrigerators are designed with oversized and balanced refrigeration systems. These include efficient evaporators and condensers for faster cooling and greater efficiency.
- HIGH-DENSITY POLYURETHANE INSULATION**
 The entire cabinet structure and solid doors are foamed-in-place using high density, CFC free polyurethane insulation.
- SIDE MOUNT COMPRESSOR UNIT**
 By positioning the compressor on the side of the unit, refrigerators can now be serviced without being moved. Our innovative, front breathing feature also allows this model to provide high efficiency in narrow spaces.

Model	Drawer	Capacity (litres)	HP	AMPS	Crated Weight (kg)	W x D x H (mm)
TCBE-96SDR	4	651	1/4	3.7	219	2447 x 815 x 649

Ver.DEC.2015

www.austunecommercial.com



CHEF BASE - D815

REFRIGERATOR
MODEL : TCBE-96SDR

Model : TCBE-96SDR

SPEC SHEET	TCBE-96SDR
Classification	Refrigerator
Cabinet dimension (WxDxH mm)	2447x815x649
Capacity (Liters)	651
Inner Temperature	1°C ~ 8°C
Ambient Temperature	40°C
Drawer	4
Refrigerant	R-134a
Compressor (HP)	1/4
Cooling Type	Fan cooling type
Insulation Type	Polyurethane/ Cyclopentane+CFC Free
Temperature Control Type	Thermostat
Amps (A)	3.7
Voltage (V/Hz/Ph)	240V 50Hz 1Ph
Power (W)	366
Weight (Kg)	219

Design and specifications subject to change without notice.
Actual shipping weight may differ due to extra packing materials for product protection.

- SELF-CONTAINED SYSTEM
- 4" SWIVEL CASTERS

PLAN VIEW

(unit : mm)

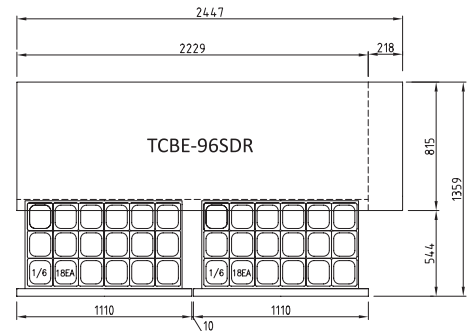

TOP VIEW

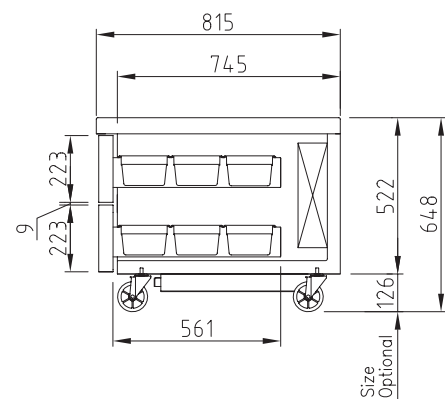

SIDE VIEW

WARRANTY 2 YEARS
PARTS & LABOUR

Ver.DEC.2015



Unit 1, 79-85 Mars Road, Lane Cove West NSW 2066
Tel: (02) 9420 4477
www.austunecommercial.com

REFRIGERATOR MANUFACTURER
Turbo air

Austune
1800 FRIDGE

