

Camcarts®

Double Compartment

For GN 1/1 Full Size Food Pans

Models UPC600

UPC1200



Features & Benefits

- These large capacity Camcarts easily handle storing and transporting food for any catering job, large or small, for hot or cold foods.
- GN 1/1 Full Size Food Pan capacity per compartment:
 - Model UPC600**
1 each 8" (20 cm) deep, 2 each 6" (15 cm) deep
3 each 4" (10 cm) deep, 4 each 2 1/2" (6,5 cm) deep
Also holds GN 1/2 & 1/3 Size Food Pans.
 - Model UPC1200**
2 each 8" (20 cm) deep, 4 each 6" (15 cm) deep
6 each 4" (10 cm) deep, 8 each 2 1/2" (6,5 cm) deep
Also holds GN 1/2 Long Size Food Pans.
- Store hot and cold foods in the same compartment with the use of the optional ThermoBarrier® Insulated Shelf Divider. Keep food chilled for 8 hours or more with the optional Camchiller®. No external power or ice required.
- Maintain hot food holding temperatures at higher levels and for longer when using two Camwarmers® inside each compartment of the UPC600 or UPC1200 models. Place on bottom rails or on bottom trays.
- Tough, one-piece seamless, double-wall, polyethylene construction is easy to maintain and won't dent, crack, rust, chip or break.
- Thick polyurethane foam insulated compartments and air tight gaskets help to maintain food quality and temperatures without the use of external heat sources.
- Durable nylon door latches are easy to open and close securely to provide maximum temperature retention. Full swing doors open 270° to the side for easy loading and unloading.
- Vent cap on each compartment allows steam to be released and keeps menu items from becoming soggy.
- Molded-in vertical handles are located in the back for effective maneuvering during transport. Molded-in bumper minimizes damage to walls and furniture.
- Heavy-duty casters provide for smooth transporting and maneuvering across all types of terrain.
 - Model UPC600 - Four each 5" (12,7 cm), 2 fixed, 2 swivel, 1 w/ brake
 - Model UPC1200 - Four each 6" (15,24 cm), 2 fixed, 2 swivel, 1 w/ brake
- Optional lifting strap (1826STP) available for UPC1200.
- Non-electrical.
- No assembly required.
- Available in 11 colors.

Item No. _____

Specifier Identification No. _____

Model No. _____

Quantity _____



UPC600



UPC1200



Camwarmer®



Add the Camchiller (CP1220) to create a portable non-electric refrigerator.



The ThermoBarrier separates hot and cold food in the same compartment.

Approvals



Double Compartment

For GN 1/1 Full Size Food Pans

Models UPC600

UPC1200

Item No. _____

Specifier Identification No. _____

Model No. _____

Quantity _____

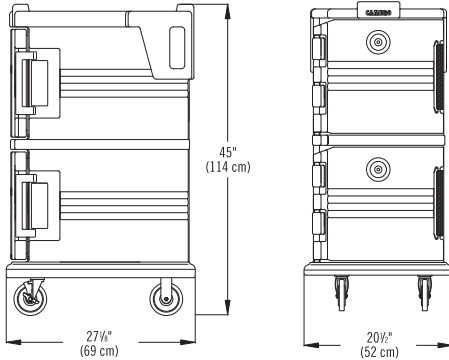

UPC600

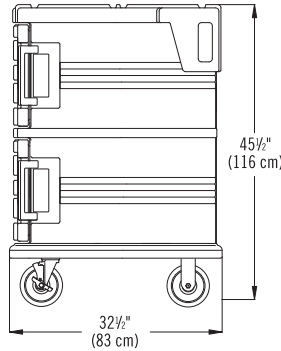

UPC1200

Specifications

Dimension Tolerance: +/- 1/4" (0,64 cm)

Code	Description	Exterior Dimensions W x D x H (with casters)	Dimensions W x D x H (per cavity)	Case lbs./cube Kg/m ³
UPC600	Camcart for Food Pans	20 1/2" x 27 1/2" x 45" (52 x 69 x 114 cm)	13 3/4" x 21" x 13 1/2" (34 x 53 x 35 cm)	83 (15.31) 37,6 (0,43)
UPC1200	Camcart for Food Pans	28 1/2" x 32 1/2" x 45 1/2" (72 x 83 x 116 cm)	21 1/8" x 26 1/8" x 13 1/2" (54 x 66 x 35 cm)	110 (25.80) 49,8 (0,73)

Optional Accessories

- ThermoBarrier®**
- 300DIV for UPC600
Coffee Beige (157)
 - 1200DIV for UPC1200
Dark Brown (131)
- Camchiller®**
- CP1220
Cold Blue (159)
- Camwarmer®**
- 1210PW
Granite Gray (191)
- Lifting Strap**
- 1826STP for UPC1200
Beige (100)

Standard Colors

- Navy Blue (186)
- Dark Brown (131)
- Black (110)
- Granite Green (192)
- Slate Blue (401)
- Brick Red (402)
- Hot Red (158)
- Granite Sand (194)
- Coffee Beige (157)
- Green (519)
- Granite Gray (191)

Architect Specs

The non-electrical food service and transport cart shall be a Camcart, Model ..., manufactured by Cambro Mfg. Co., Huntington Beach, CA 92647 U.S.A. It shall be made of one-piece, seamless, double-wall, high-density, polyethylene. It shall have 2 separate insulated polyurethane foam-injected compartments. Each compartment shall accommodate a variety of GN 1/1 Full, 1/2 or 1/3 Size Food Pans, from 2 1/2" (6,5 cm) to 8" (20 cm) deep. It shall have nylon door latches and the compartment doors swing open 270°. It shall have a vent cap on each compartment.

It shall have molded-in handles located on the back of the cart. It shall have either 4 each 6" (15,24 cm) casters, 2 fixed, 2 swivel, 1 w/ brake or 4 each 5" (12,7 cm) casters, 2 fixed, 2 swivel, 1 w/ brake. It shall be available with an optional lifting strap for the UPC1200. It shall require no assembly. It shall be available in 11 colors.

Approvals

