

Zip HydroChill

Solutions for the workplace



Chilled & sparkling filtered water
High capacity for bottle filling

Pure-tasting filtered water on demand to keep up with a busy workplace

Promote healthy hydration at work with Zip HydroChill, a range of flexible high-capacity filtered water systems

Zip HydroChill systems provide premium high quality & high capacity filtered water on tap, enabling staff to stay hydrated at all times.

Unlimited hydration for employees and guests not only means a healthier, more productive workplace but a greener business. Remove the need for disposable plastic water bottles when you install a Zip HydroChill.

Having pure-tasting filtered chilled, sparkling and ambient water on demand means staff can refill their water bottles and enjoy water in a form they want in an instant. Fill carafes and jugs for meetings and functions with ease.

- **Perfect for high demand**

With the ability to cater for as much filtered chilled, sparkling and ambient water as required, Zip HydroChill offers a range of drinking water solutions, no matter the size of your organisation.

- **Eco-friendly**

Great-tasting water, instantly, without a plastic bottle in sight.

- **Pure tasting water**

Thanks to Zip's MicroPurity filtration, Zip HydroChill delivers pure-tasting water that uses our latest filtration technology to reduce impurities and potentially harmful contaminants.

- **Water capacity to suit any workplace**

Zip HydroChill can deliver up to 200 litres of chilled filtered drinking water per hour, straight from the tap.

- **Wellness in the workplace**

Staying hydrated at work not only helps employees stay healthy, it also positively impacts on productivity. Drinking water regularly throughout the day helps you stay alert, improves concentration and means you're less likely to get stressed.

- **Certification**

Zip Water offers the widest commercial range of high capacity chilled sparkling water systems in Australia, all certified to the Australian & New Zealand WaterMark standard.

Pure-tasting water with Zip HydroChill MicroPurity filtration

Zip HydroChill uses our latest MicroPurity filtration technology, with a 0.2 micron filter to deliver pure tasting water.

It is certified to reduce chlorine, taste, odour, bacteria, sediment and limescale in line with NSF 42 (aesthetic effects) and WaterMark requirements. Zip MicroPurity filtration is also certified to deliver a reduction of 99.9% of cysts including cryptosporidium and giardia, and lead reduction of 98.9% to NSF 53 (health effects).



WM - 022314

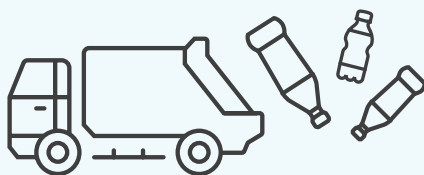

Australians buy over **580m** litres of bottled water a year. Much of which ends up in landfill and on our beaches.



Eliminate the need for bottled water reducing your environmental impact

Expert service from Zip Water

Get access to our nationwide network of over 100 certified Zip technicians, giving you prompt, hassle free and efficient support.



Fast & Reliable

100+ experienced water appliance technicians
Australia-wide



Professional

Our technicians are qualified experts, trained to professionally service and maintain all Zip Water systems



Zip HydroChill model range

High capacity Chilled Sparkling and Ambient water designed for corporate and commercial applications.

❄️ Chilled ❄️💧 Sparkling 💧 Ambient

Water Options	❄️💧	❄️💧
Order Code	HCS090	HCF090
Tap	3-tap	2-tap
Drip Tray	Fixed position plumbed to drain	
Recovery	90 litres per hour	
Power	230V 50/60Hz Dedicated 10amp GPO	
Water Connection	12.5mm BSP potable cold water	
Filter	0.2 micron filter	
CO2	2.6kg food grade CO2 cylinder Applies only to HCS090	

❄️ Chilled ❄️💧 Sparkling 💧 Ambient

Water Options	❄️💧	❄️💧
Order Code	HCS120	HCF120
Tap	3-tap	2-tap
Drip Tray	Fixed position plumbed to drain	
Recovery	120 litres per hour	
Power	230V 50/60Hz Dedicated 10amp GPO	
Water Connection	12.5mm BSP potable cold water	
Filter	0.2 micron filter	
CO2	2.6kg food grade CO2 cylinder Applies only to HCS120	

❄️ Chilled ❄️💧 Sparkling 💧 Ambient

Water Options	❄️💧	❄️💧
Order Code	HCS200	HCF200
Tap	3-tap	2-tap
Drip Tray	Fixed position plumbed to drain	
Recovery	200 litres per hour	
Power	230V 50/60Hz Dedicated 10amp GPO	
Water Connection	12.5mm BSP potable cold water	
Filter	0.2 micron filter	
CO2	2.6kg food grade CO2 cylinder Applies only to HCS200	

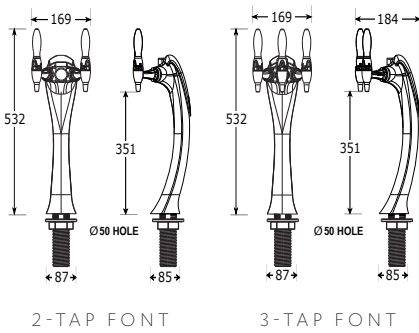

Ventilation specification: Single cupboard

- Install kit no. 93159 (supplied separately)
- Dual auxiliary fan & grille (power outlet required)
 - Air inlet grille

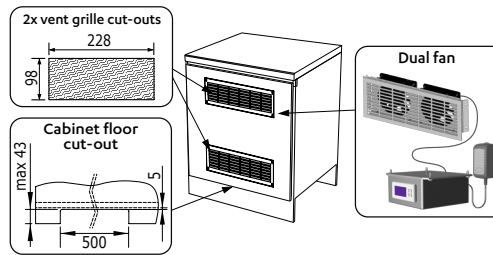

Ventilation specification: Double cupboard

- 60% open area, perforated or expanded metal door (supplied by others)
- 2x cabinet floor cut-outs

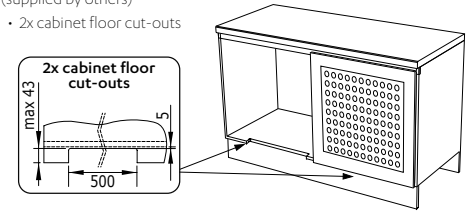

- Ambient water
- Sparkling water
- Chilled water
- Water/CO2 supply
- Filter hoses

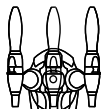

Drip tray options

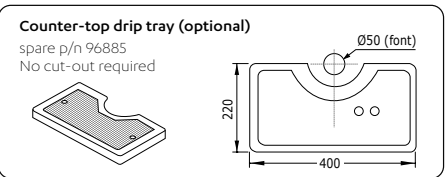
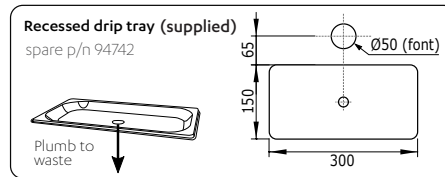

Insulate all hoses to font

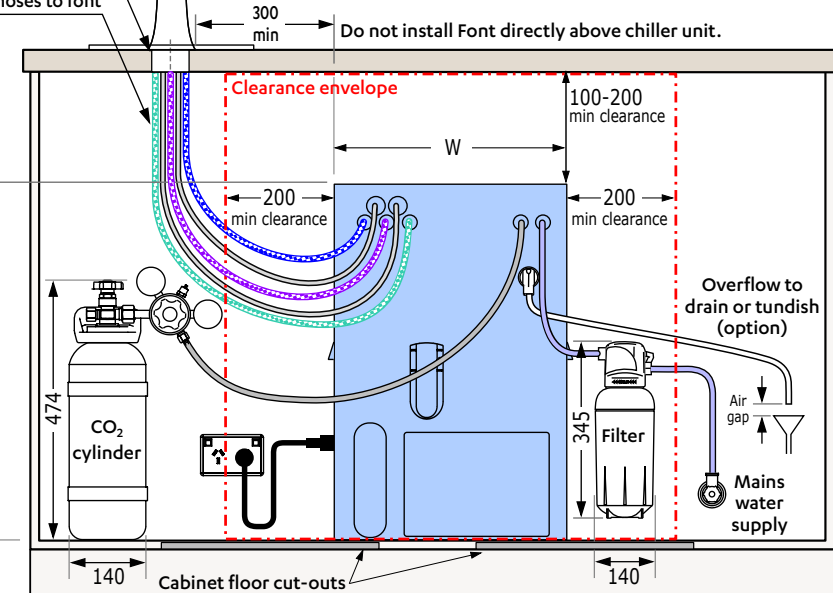

Model	Width	Depth	Height	Clearance above chiller
HCS090 HCF090	333	407	610	100
HCS120 HCF120	425	425	650	200
HCS200 HCF200	491	541	745	200

All dimensions in millimetres

Cylinder only included for Zip HydroChill: Chilled Sparkling Filtered
HCS090, HCS120, HCS200

Zip HydroChill product details

Zip HydroChill features a stylish design that can be customised to suit your office space. It is an ideal solution for high traffic areas such as a staff kitchen or boardroom, with bench storage to house the under bench system.

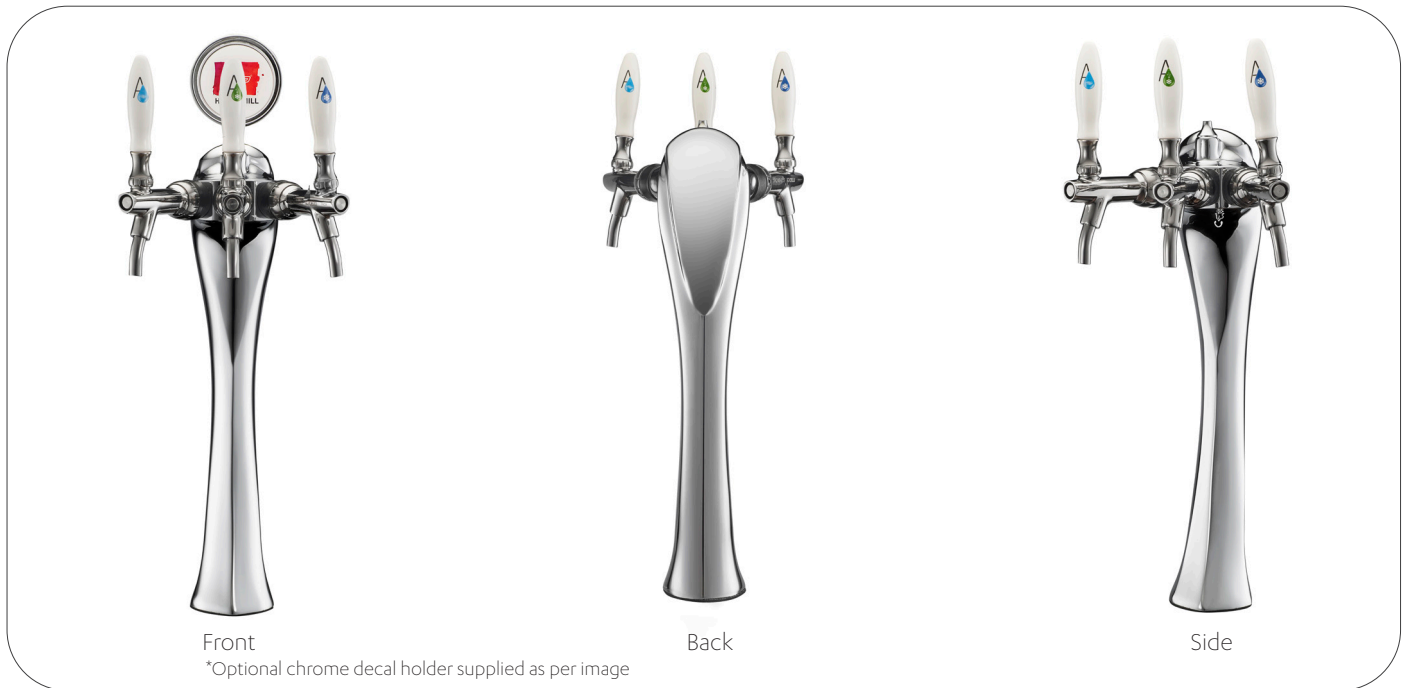

3-tap font



Drip tray

Capacity options	
Litres per hour	Bottles per hour*
90	120
120	160
200	267

*Based on a 750ml bottle

Zip HydroChill product codes			
Code	Filtered chilled and sparkling	Filtered chilled and ambient	Litres per hour
HCS090	✓		90
HCS120	✓		120
HCS200	✓		200
HCF090		✓	90
HCF120		✓	120
HCF200		✓	200

Water Combinations	
Filtered chilled and ambient	Filtered chilled and sparkling
Two tap column font	Three tap column font



AUSTRALIA 1800 947 827

zipwater.com